

## CARMEN-RS-C

~10° spot beam. Assembly with holder C compatible with LEDiL HEKLA.

### TECHNICAL SPECIFICATIONS:

Dimensions	Ø 69.5 mm
Height	41.5 mm
Fastening	socket
ROHS compliant	yes ⓘ

### MATERIAL SPECIFICATIONS:

Component	Type	Material	Colour	Finish
CARMEN-RS	Single lens	PMMA	clear	
CARMEN-HLD-C	Holder	PC	black	

### ORDERING INFORMATION:





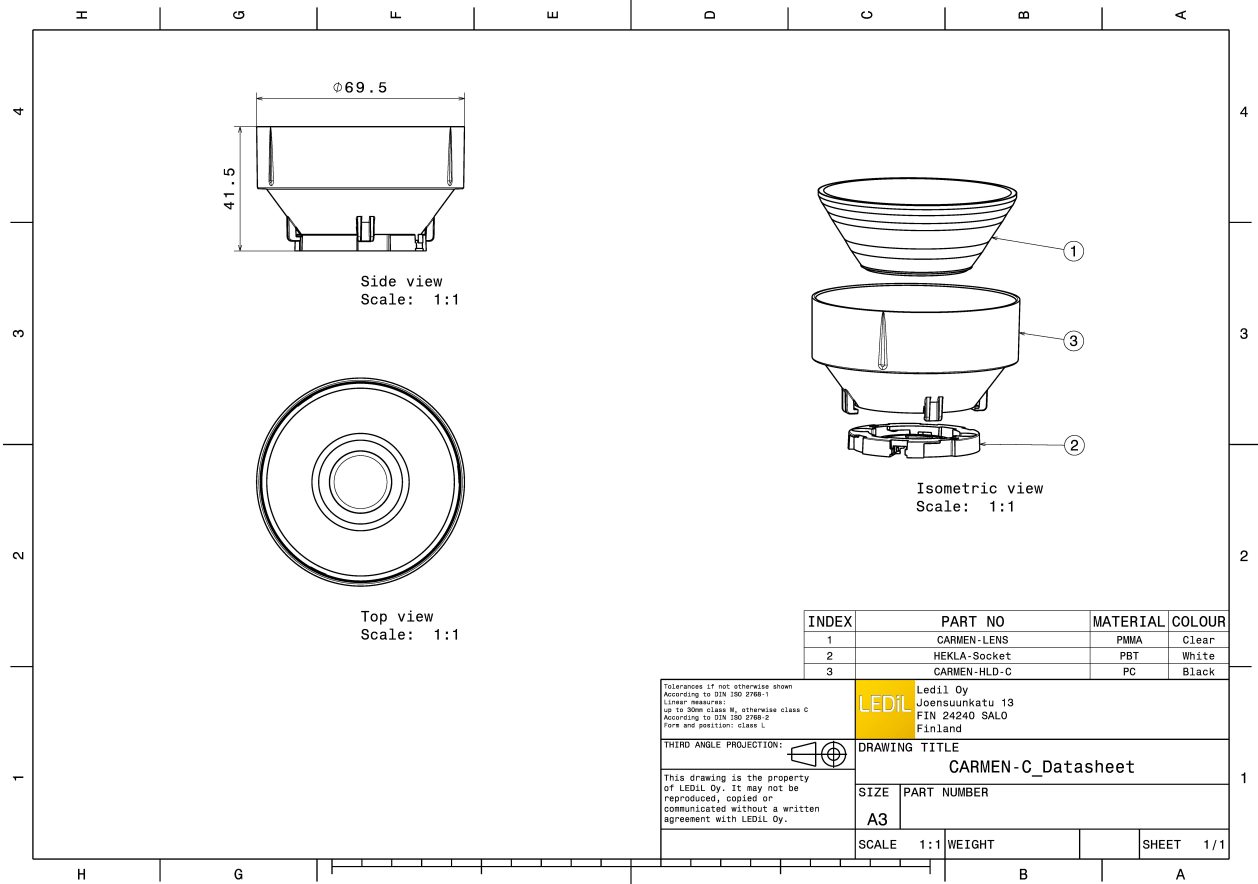

Component	Type	Qty in box	MOQ	MPQ	Box weight (kg)
CP15916_CARMEN-RS-C » Box size: 480 x 280 x 300 mm	Single lens	150	150	15	6.2



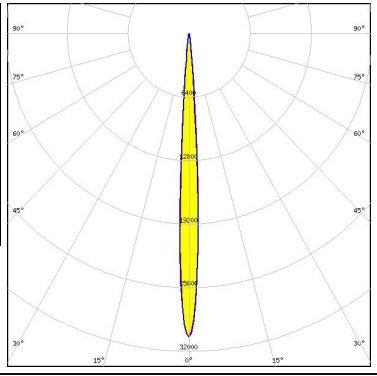

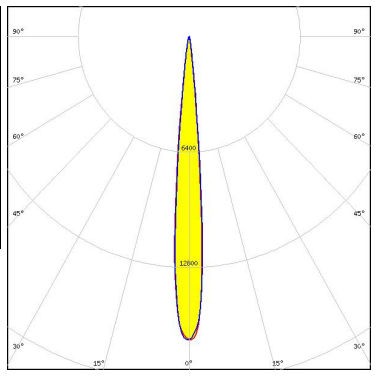
See also our general installation guide: [www.ledil.com/installation\\_guide](http://www.ledil.com/installation_guide)

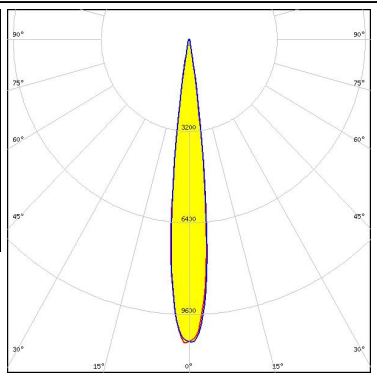
#### PHOTOMETRIC DATA (MEASURED):

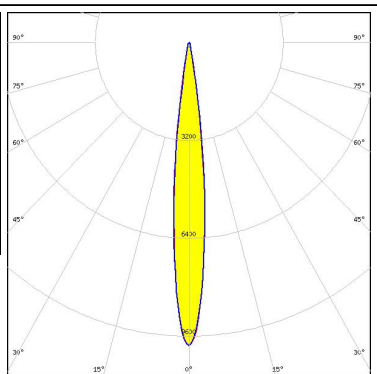
<p>bridgelux.</p> <p>LED V4 HD</p> <p>FWHM / FWTM 7.0° / 12.0°</p> <p>Efficiency 68 %</p> <p>Peak intensity 31 cd/lm</p> <p>LEDs/each optic 1</p> <p>Light colour White</p> <p>Required components: F15253_HEKLA-SOCKET-A</p>		
<p>bridgelux.</p> <p>LED V6 HD</p> <p>FWHM / FWTM 9.6° / 15.0°</p> <p>Efficiency 65 %</p> <p>Peak intensity 16.9 cd/lm</p> <p>LEDs/each optic 1</p> <p>Light colour White</p> <p>Required components: F15255_HEKLA-SOCKET-C</p>		
<p>bridgelux.</p> <p>LED V9 HD</p> <p>FWHM / FWTM 13.0° / 20.0°</p> <p>Efficiency 63 %</p> <p>Peak intensity 10.6 cd/lm</p> <p>LEDs/each optic 1</p> <p>Light colour White</p> <p>Required components: F15859_HEKLA-SOCKET-I</p>		
<p>bridgelux.</p> <p>LED VERO10</p> <p>FWHM / FWTM 12.0° / 21.0°</p> <p>Efficiency 61 %</p> <p>Peak intensity 9.9 cd/lm</p> <p>LEDs/each optic 1</p> <p>Light colour White</p> <p>Required components: F15616_HEKLA-SOCKET-F</p>		

#### PHOTOMETRIC DATA (MEASURED):

**bridgelux.**

LED Vesta TW 6mm DP  
 FWHM / FWTM 9.0° / 16.0°  
 Efficiency 59 %  
 Peak intensity 16.5 cd/lm  
 LEDs/each optic 1  
 Light colour White

Required components:  
 C16142\_HEKLA-SOCKET-K  
 Bender Wirth: 504 Typ L8



**bridgelux.**

LED Vesta TW 9mm (9W) DP  
 FWHM / FWTM 12.0° / 23.0°  
 Efficiency 56 %  
 Peak intensity 7.8 cd/lm  
 LEDs/each optic 1  
 Light colour White

Required components:  
 C16142\_HEKLA-SOCKET-K  
 Bender Wirth: 489 Typ L8



**CITIZEN**

LED CLL02x/CLU02x (LES10)  
 FWHM / FWTM 13.0° / 22.0°  
 Efficiency 59 %  
 Peak intensity 8.6 cd/lm  
 LEDs/each optic 1  
 Light colour White

Required components:  
 F15255\_HEKLA-SOCKET-C



**CITIZEN**

LED CLU700/701/702  
 FWHM / FWTM 9.0° / 15.0°  
 Efficiency 69 %  
 Peak intensity 22.6 cd/lm  
 LEDs/each optic 1  
 Light colour White

Required components:  
 F15255\_HEKLA-SOCKET-C

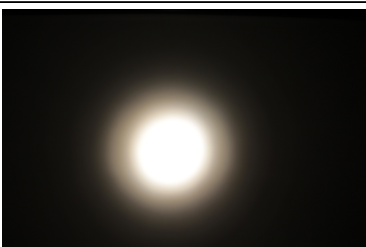
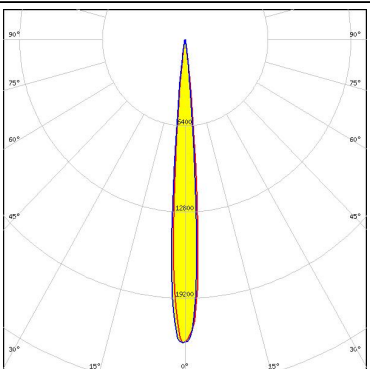
#### PHOTOMETRIC DATA (MEASURED):

#### CITIZEN

LED CLU700/701/702  
 FWHM / FWTM 8.0° / 15.0°  
 Efficiency 62 %  
 Peak intensity 20.2 cd/lm  
 LEDs/each optic 1  
 Light colour White  
 Required components:  
 F15255\_HEKLA-SOCKET-C

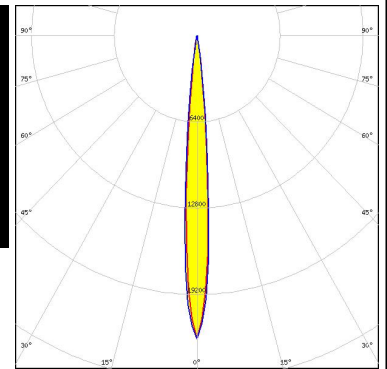

#### CITIZEN

LED CLU710/711  
 FWHM / FWTM 12.0° / 19.0°  
 Efficiency 64 %  
 Peak intensity 11.5 cd/lm  
 LEDs/each optic 1  
 Light colour White  
 Required components:  
 F15859\_HEKLA-SOCKET-I

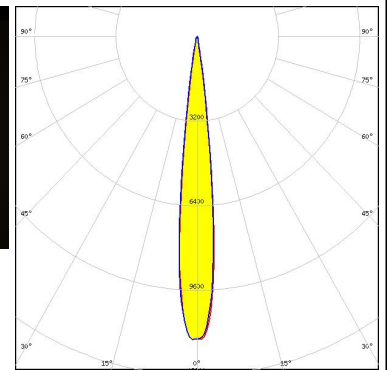
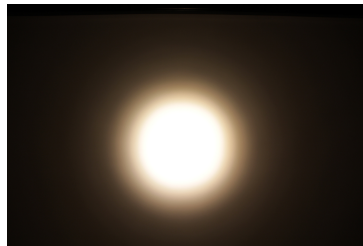

#### CITIZEN

LED CLU7A2 (LES 4.2mm)  
 FWHM / FWTM 6.0° / 11.0°  
 Efficiency 65 %  
 Peak intensity 34.7 cd/lm  
 LEDs/each optic 1  
 Light colour White  
 Required components:  
 F15255\_HEKLA-SOCKET-C

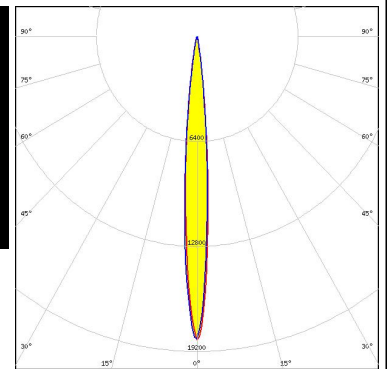

#### CITIZEN

LED CLU7B2  
 FWHM / FWTM 6.0° / 10.0°  
 Efficiency 66 %  
 Peak intensity 43.4 cd/lm  
 LEDs/each optic 1  
 Light colour White  
 Required components:  
 F15255\_HEKLA-SOCKET-C

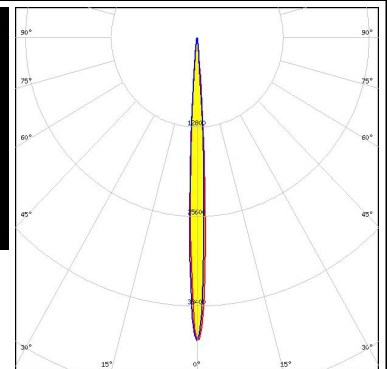

#### PHOTOMETRIC DATA (MEASURED):

##### CREE LED

LED CMA1516  
 FWHM / FWTM 13.0° / 20.0°  
 Efficiency 63 %  
 Peak intensity 9.7 cd/lm  
 LEDs/each optic 1  
 Light colour White  
 Required components:  
 F15256\_HEKLA-SOCKET-D

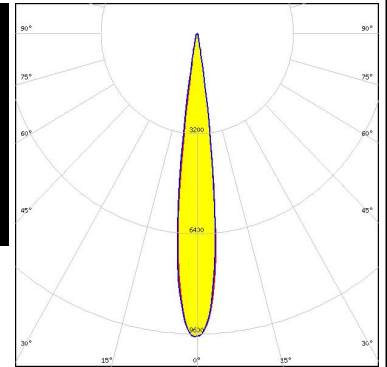

##### CREE LED

LED CMT14xx  
 FWHM / FWTM 14.0° / 23.0°  
 Efficiency 40 %  
 Peak intensity 5 cd/lm  
 LEDs/each optic 1  
 Light colour White  
 Required components:  
 F15255\_HEKLA-SOCKET-C

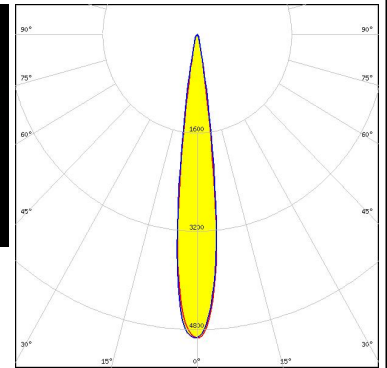

##### CREE LED

LED CXA/B 13xx  
 FWHM / FWTM 8.0° / 15.0°  
 Efficiency 64 %  
 Peak intensity 21.4 cd/lm  
 LEDs/each optic 1  
 Light colour White  
 Required components:  
 F15956\_HEKLA-SOCKET-J

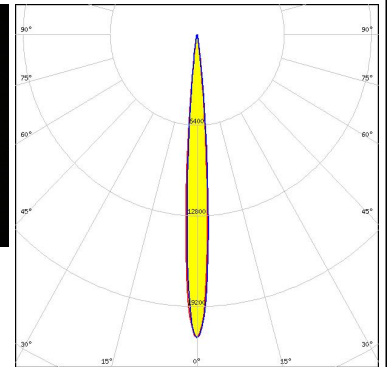

##### CREE LED

LED CXA/B 15xx  
 FWHM / FWTM 13.0° / 20.0°  
 Efficiency 65 %  
 Peak intensity 11.3 cd/lm  
 LEDs/each optic 1  
 Light colour White  
 Required components:  
 F15256\_HEKLA-SOCKET-D

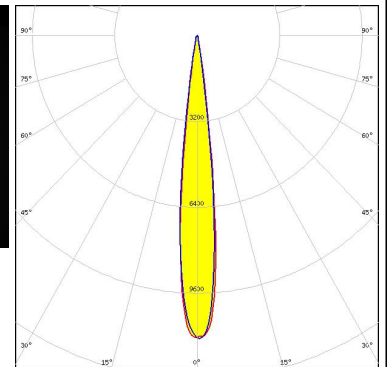

#### PHOTOMETRIC DATA (MEASURED):



LED CXA/B 1816 & CXA/B 1820 & CXA 1850  
 FWHM / FWTM 17.0° / 26.0°  
 Efficiency 59 %  
 Peak intensity 5.6 cd/lm  
 LEDs/each optic 1  
 Light colour White  
 Required components:  
 F15256\_HEKLA-SOCKET-D

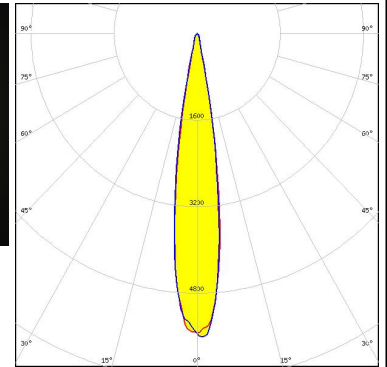

LED LUXEON CX Plus CoB L08 (Gen2)  
 FWHM / FWTM 17.0° / 30.0°  
 Efficiency 54 %  
 Peak intensity 4.3 cd/lm  
 LEDs/each optic 1  
 Light colour White  
 Required components:  
 Bender Wirth: 637a Hekla

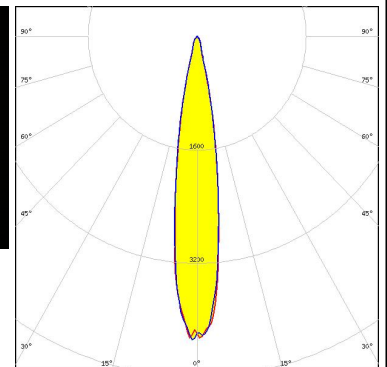

LED LUXEON CoB 1202HD  
 FWHM / FWTM 9.7° / 15.0°  
 Efficiency 66 %  
 Peak intensity 18.5 cd/lm  
 LEDs/each optic 1  
 Light colour White  
 Required components:  
 F15848\_HEKLA-SOCKET-G

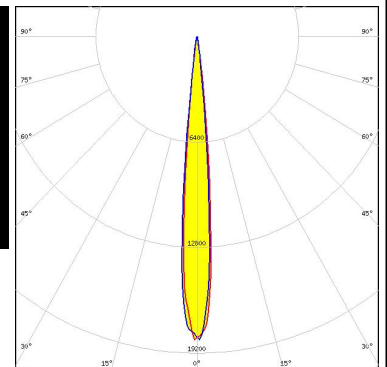
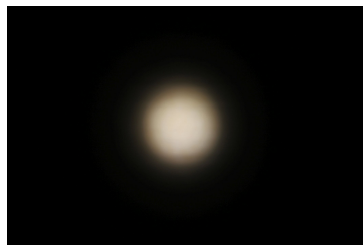

LED LUXEON CoB 1204HD  
 FWHM / FWTM 13.0° / 20.0°  
 Efficiency 63 %  
 Peak intensity 10 cd/lm  
 LEDs/each optic 1  
 Light colour White  
 Required components:  
 F15858\_HEKLA-SOCKET-H

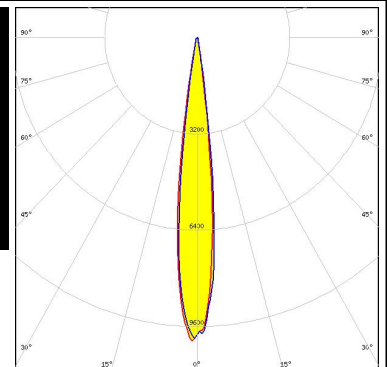

#### PHOTOMETRIC DATA (MEASURED):

#### LUMILEDS

LED LUXEON CoB 1205HD  
 FWHM / FWTM 15.0° / 25.0°  
 Efficiency 59 %  
 Peak intensity 6.4 cd/lm  
 LEDs/each optic 1  
 Light colour White  
 Required components:  
 F15858\_HEKLA-SOCKET-H

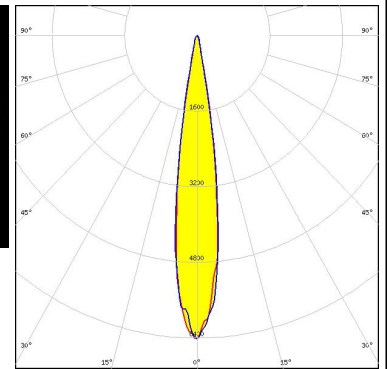

#### LUMILEDS

LED LUXEON CX Plus CoB - HD S01H4  
 FWHM / FWTM 8.0° / 14.0°  
 Efficiency 67 %  
 Peak intensity 27.5 cd/lm  
 LEDs/each optic 1  
 Light colour White  
 Required components:  
 Bender Wirth: 634c Hekla

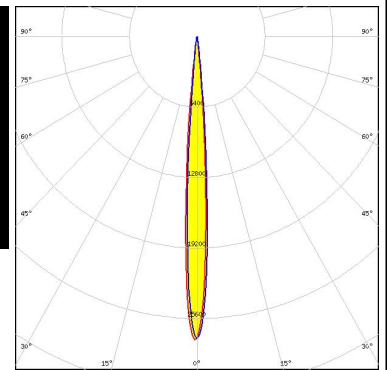
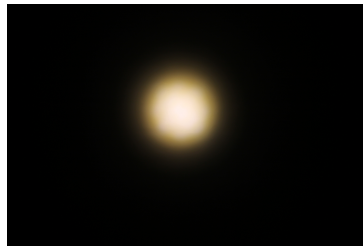

#### LUMILEDS

LED LUXEON CX Plus CoB - HD S04H9  
 FWHM / FWTM 13.0° / 20.0°  
 Efficiency 61 %  
 Peak intensity 10.3 cd/lm  
 LEDs/each optic 1  
 Light colour White  
 Required components:  
 Bender Wirth: 634c Hekla

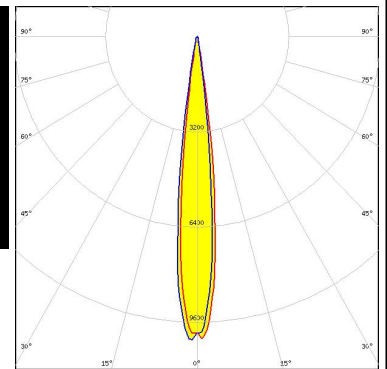



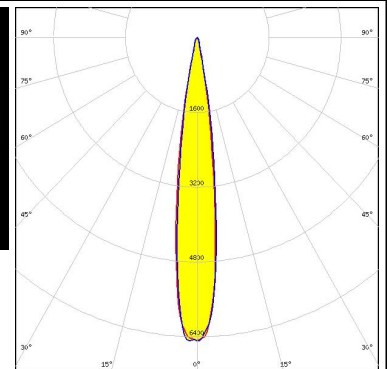

#### LUMILEDS

LED LUXEON CX Plus CoB L04 / L05 (Gen2)  
 FWHM / FWTM 15.0° / 26.0°  
 Efficiency 58 %  
 Peak intensity 6.5 cd/lm  
 LEDs/each optic 1  
 Light colour White  
 Required components:  
 Bender Wirth: 637a Hekla



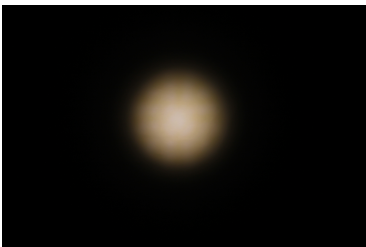
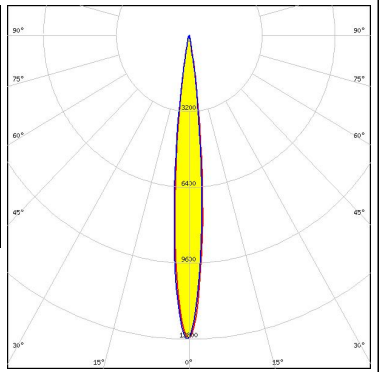
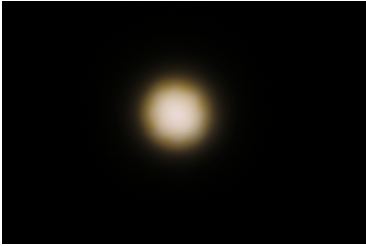
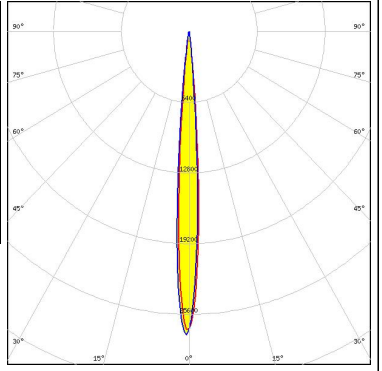

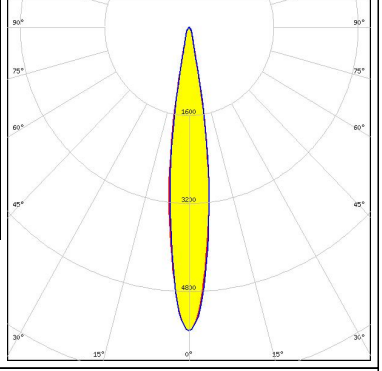
#### PHOTOMETRIC DATA (MEASURED):

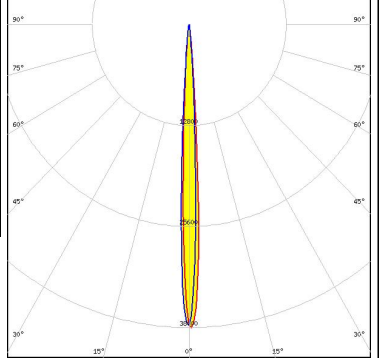
<p><b>LUMILEDS</b></p> <p>LED LUXEON CX Plus CoB M02 / M03 (Gen2)</p> <p>FWHM / FWTM 11.0° / 20.0°</p> <p>Efficiency 62 %</p> <p>Peak intensity 12.8 cd/lm</p> <p>LEDs/each optic 1</p> <p>Light colour White</p> <p>Required components: Bender Wirth: 641a Hekla</p>		
<p><b>LUMILEDS</b></p> <p>LED LUXEON CX Plus CoB S01 (Gen2)</p> <p>FWHM / FWTM 8.0° / 14.0°</p> <p>Efficiency 66 %</p> <p>Peak intensity 27.5 cd/lm</p> <p>LEDs/each optic 1</p> <p>Light colour White</p> <p>Required components: Bender Wirth: 634c Hekla</p>		
<p><b>LUMINUS</b></p> <p>LED CxM-11 (19x19)</p> <p>FWHM / FWTM 15.0° / 26.0°</p> <p>Efficiency 56 %</p> <p>Peak intensity 5.5 cd/lm</p> <p>LEDs/each optic 1</p> <p>Light colour White</p> <p>Required components: F15859_HEKLA-SOCKET-I</p>		
<p><b>LUMINUS</b></p> <p>LED CXM-3</p> <p>FWHM / FWTM 6.0° / 11.0°</p> <p>Efficiency 66 %</p> <p>Peak intensity 38.5 cd/lm</p> <p>LEDs/each optic 1</p> <p>Light colour White</p> <p>Required components: F15255_HEKLA-SOCKET-C</p>		

#### PHOTOMETRIC DATA (MEASURED):



LED CXM-4  
 FWHM / FWTM 7.0° / 13.0°  
 Efficiency 63 %  
 Peak intensity 28.1 cd/lm  
 LEDs/each optic 1  
 Light colour White  
 Required components:  
 F15255\_HEKLA-SOCKET-C

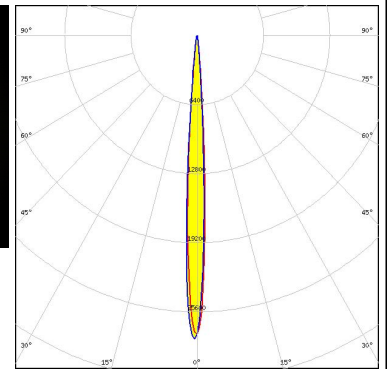

LED CxM-9 (13.5x13.5)  
 FWHM / FWTM 13.0° / 21.0°  
 Efficiency 59 %  
 Peak intensity 9.3 cd/lm  
 LEDs/each optic 1  
 Light colour White  
 Required components:  
 F15255\_HEKLA-SOCKET-C

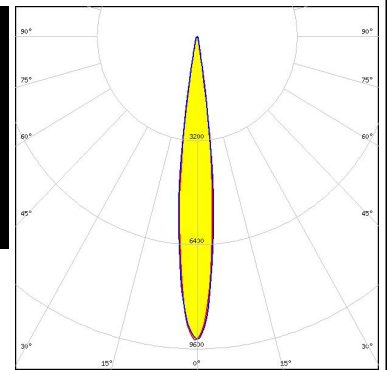

LED Fortimo SLM L09 CoB  
 FWHM / FWTM 13.0° / 21.0°  
 Efficiency 63 %  
 Peak intensity 9.6 cd/lm  
 LEDs/each optic 1  
 Light colour White  
 Required components:  
 F15858\_HEKLA-SOCKET-H

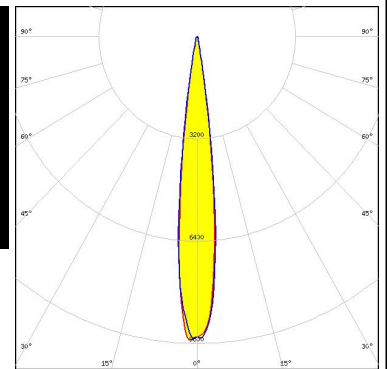
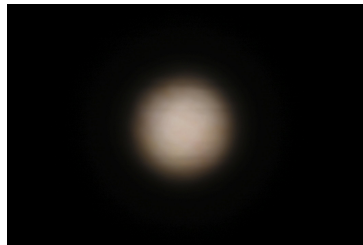

LED LC003D / LC006D / LC009D / LC013D  
 FWHM / FWTM 13.0° / 21.0°  
 Efficiency 60 %  
 Peak intensity 9.3 cd/lm  
 LEDs/each optic 1  
 Light colour White  
 Required components:  
 F15255\_HEKLA-SOCKET-C

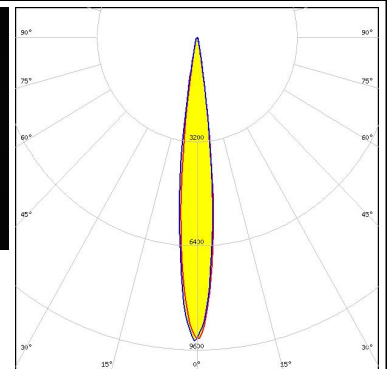
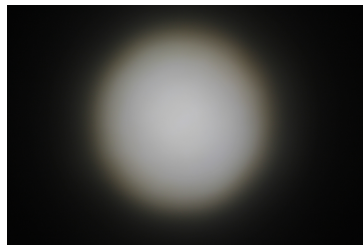

#### PHOTOMETRIC DATA (MEASURED):

### SAMSUNG

LED LC020C  
 FWHM / FWTM 11.0° / 19.0°  
 Efficiency 61 %  
 Peak intensity 12 cd/lm  
 LEDs/each optic 1  
 Light colour White  
 Required components:  
 F15848\_HEKLA-SOCKET-G

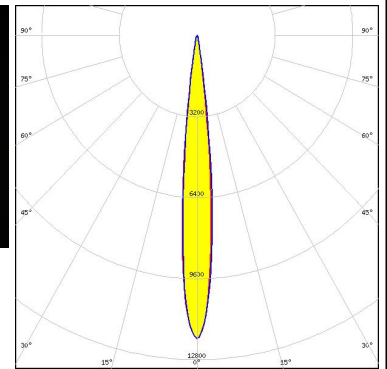

### SAMSUNG

LED LC020C G2  
 FWHM / FWTM 12.0° / 20.0°  
 Efficiency 59 %  
 Peak intensity 10 cd/lm  
 LEDs/each optic 1  
 Light colour White  
 Required components:  
 F15859\_HEKLA-SOCKET-I

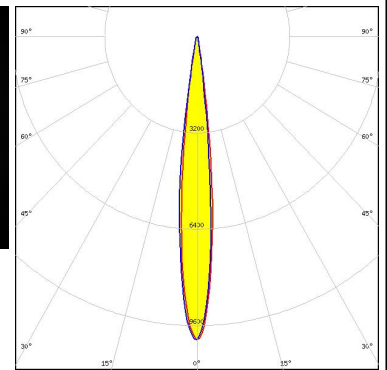

### TRIDONIC

LED SLE G7 LES09  
 FWHM / FWTM 12.0° / 19.0°  
 Efficiency 61 %  
 Peak intensity 10.9 cd/lm  
 LEDs/each optic 1  
 Light colour White  
 Required components:  
 F15255\_HEKLA-SOCKET-C

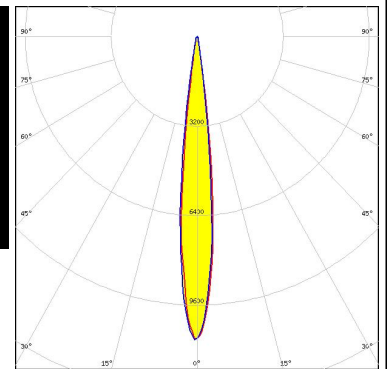

### TRIDONIC

LED SLE G7 LES13  
 FWHM / FWTM 17.0° / 28.0°  
 Efficiency 56 %  
 Peak intensity 5 cd/lm  
 LEDs/each optic 1  
 Light colour White  
 Required components:  
 F15859\_HEKLA-SOCKET-I

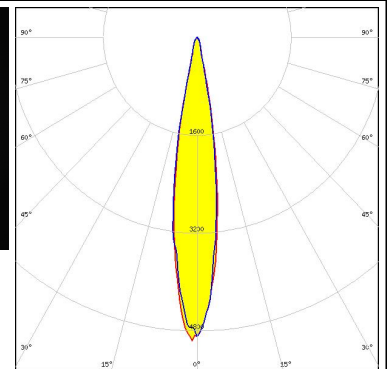
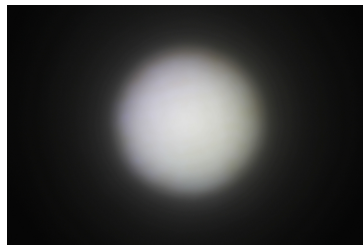

#### PHOTOMETRIC DATA (MEASURED):

#### XICATO

LED XOB 6 mm  
 FWHM / FWTM 9.0° / 15.0°  
 Efficiency 62 %  
 Peak intensity 20.1 cd/lm  
 LEDs/each optic 1  
 Light colour White  
 Required components:  
 F15255\_HEKLA-SOCKET-C

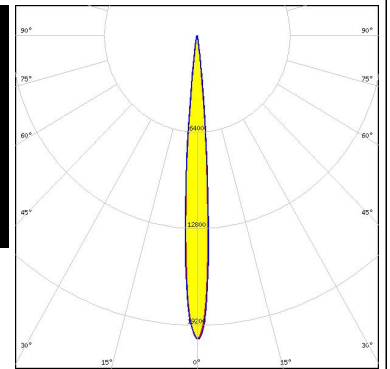
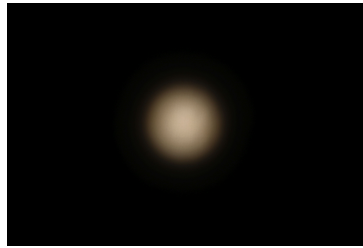

#### XICATO

LED XOB 9.8 mm  
 FWHM / FWTM 12.0° / 20.0 + 20.5°  
 Efficiency 60 %  
 Peak intensity 10.4 cd/lm  
 LEDs/each optic 1  
 Light colour White  
 Required components:  
 F15255\_HEKLA-SOCKET-C

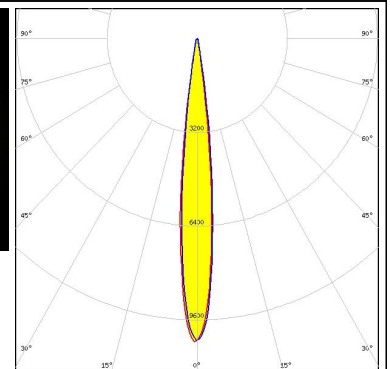

#### XICATO

LED XTM - 19mm LES  
 FWHM / FWTM 18.0° / 38.0°  
 Efficiency 50 %  
 Peak intensity 2.9 cd/lm  
 LEDs/each optic 1  
 Light colour White  
 Required components:  
 C16058\_XTM-ADAPTER-50-C

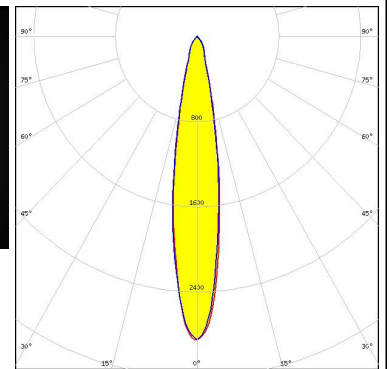

#### PHOTOMETRIC DATA (SIMULATED):



LED VERO13  
 FWHM / FWTM 15.0° / 30.0°  
 Efficiency 61 %  
 Peak intensity 5.3 cd/lm  
 LEDs/each optic 1  
 Light colour White  
 Required components:  
 C16142\_HEKLA-SOCKET-K

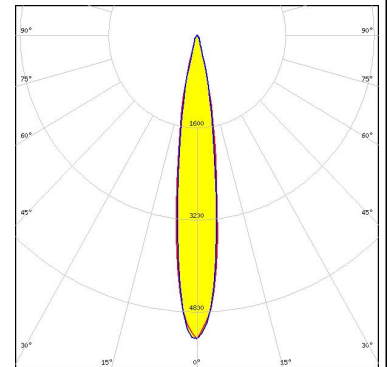

#### CITIZEN

LED CLL02x/CLU02x (LES10)  
 FWHM / FWTM 14.0° / 24.0°  
 Efficiency 45 %  
 Peak intensity 7.3 cd/lm  
 LEDs/each optic 1  
 Light colour White  
 Required components:  
 F15859\_HEKLA-SOCKET-I  
 C16752\_CARMEN-70-SHD

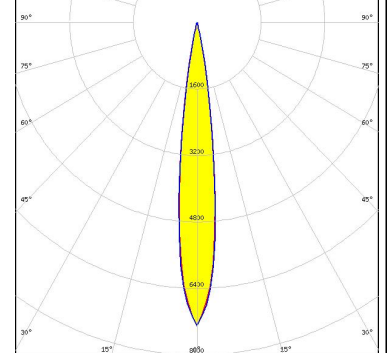

#### CITIZEN

LED CLU700/701/702  
 FWHM / FWTM 9.0° / 16.0°  
 Efficiency 51 %  
 Peak intensity 17.5 cd/lm  
 LEDs/each optic 1  
 Light colour White  
 Required components:  
 F15255\_HEKLA-SOCKET-C  
 C16752\_CARMEN-70-SHD

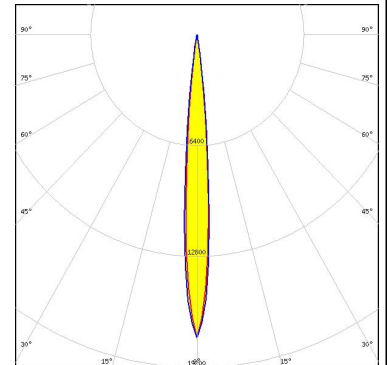

#### CITIZEN

LED CLU712  
 FWHM / FWTM 12.0° / 22.0°  
 Efficiency 64 %  
 Peak intensity 10.8 cd/lm  
 LEDs/each optic 1  
 Light colour White  
 Required components:  
 F15859\_HEKLA-SOCKET-I

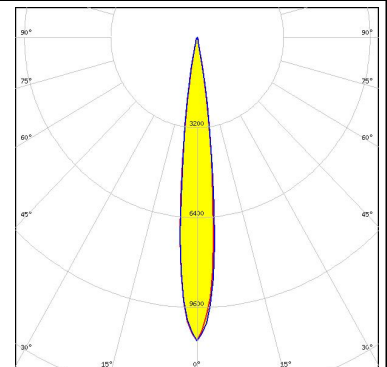

#### PHOTOMETRIC DATA (SIMULATED):

#### CITIZEN

LED CLU712  
 FWHM / FWTM 13.0° / 22.0°  
 Efficiency 47 %  
 Peak intensity 8.7 cd/lm  
 LEDs/each optic 1  
 Light colour White  
 Required components:  
 F15859\_HEKLA-SOCKET-I  
 C16752\_CARMEN-70-SHD

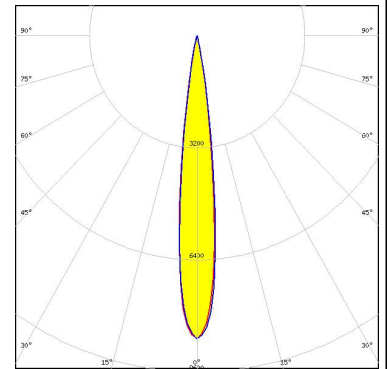

#### CITIZEN

LED CLU720/721  
 FWHM / FWTM 15.0° / 29.0°  
 Efficiency 61 %  
 Peak intensity 6.6 cd/lm  
 LEDs/each optic 1  
 Light colour White  
 Required components:  
 F15859\_HEKLA-SOCKET-I

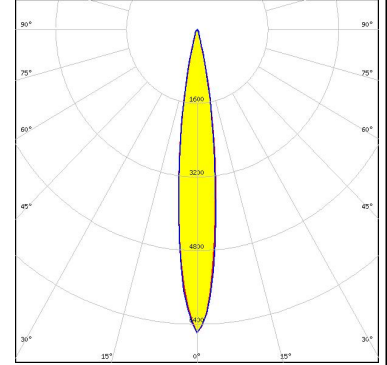

#### CITIZEN

LED CLU7A2 (LES 4.2mm)  
 FWHM / FWTM 8.0° / 14.0°  
 Efficiency 52 %  
 Peak intensity 25.9 cd/lm  
 LEDs/each optic 1  
 Light colour White  
 Required components:  
 F15255\_HEKLA-SOCKET-C  
 C16752\_CARMEN-70-SHD

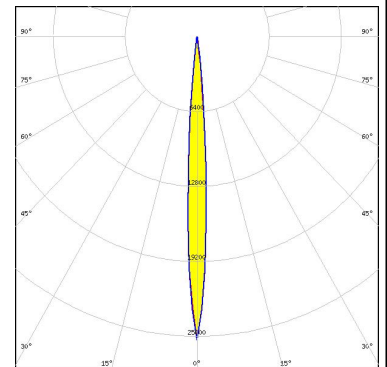

#### LUMILEDS

LED LUXEON CoB Compact  
 FWHM / FWTM 10.0° / 18.0°  
 Efficiency 71 %  
 Peak intensity 18 cd/lm  
 LEDs/each optic 1  
 Light colour White  
 Required components:  
 F15848\_HEKLA-SOCKET-G

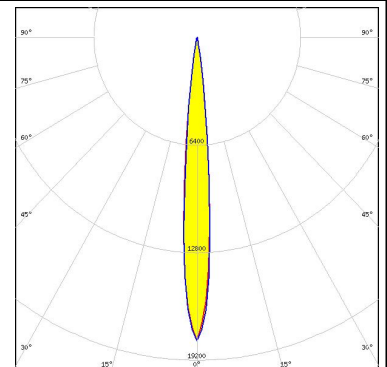

#### PHOTOMETRIC DATA (SIMULATED):

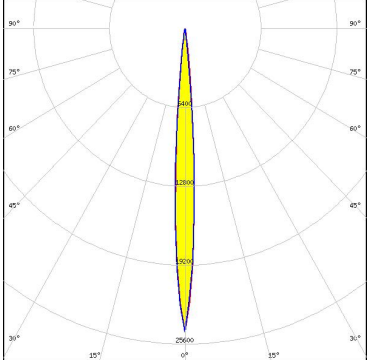
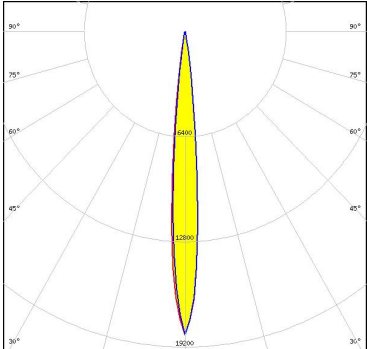
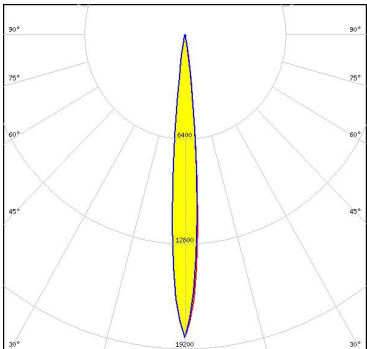
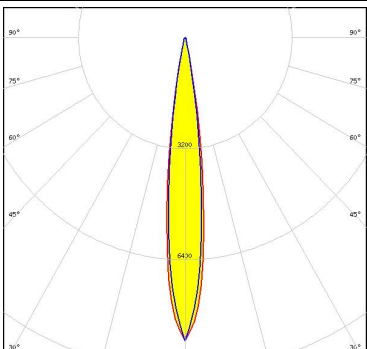
<p><b>LUMINUS</b></p> <p>LED CXM-4            FWHM / FWTM 8.0° / 14.0°            Efficiency 52 %            Peak intensity 24.6 cd/lm            LEDs/each optic 1            Light colour White            Required components:            F17435_HEKLA-G2-C            C16752_CARMEN-70-SHD</p>	
<p><b>LUMINUS</b></p> <p>LED CxM-6 (12x13)            FWHM / FWTM 10.0° / 18.0°            Efficiency 68 %            Peak intensity 18.5 cd/lm            LEDs/each optic 1            Light colour White            Required components:            F15255_HEKLA-SOCKET-C</p>	
<p><b>LUMINUS</b></p> <p>LED CxM-6 (13.5x13.5)            FWHM / FWTM 10.0° / 18.0°            Efficiency 68 %            Peak intensity 18.5 cd/lm            LEDs/each optic 1            Light colour White            Required components:            F17435_HEKLA-G2-C</p>	
<p><b>SAMSUNG</b></p> <p>LED LC003D / LC006D / LC009D / LC013D            FWHM / FWTM 13.0° / 24.0°            Efficiency 62 %            Peak intensity 8.7 cd/lm            LEDs/each optic 1            Light colour White            Required components:            F17435_HEKLA-G2-C</p>	



### PHOTOMETRIC DATA (SIMULATED):

#### SAMSUNG

LED LC003D / LC006D / LC009D / LC013D  
FWHM / FWTM 14.0° / 24.0°  
Efficiency 62 %  
Peak intensity 8.5 cd/lm  
LEDs/each optic 1  
Light colour White  
Required components:  
F17435\_HEKLA-G2-C

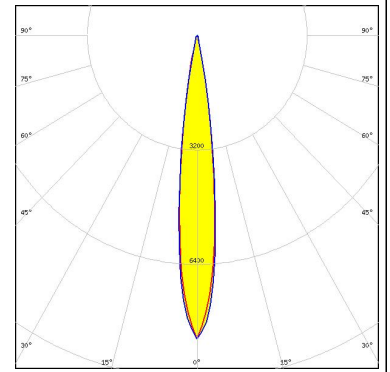

#### SAMSUNG

LED LC010C  
FWHM / FWTM 10.0° / 18.0°  
Efficiency 68 %  
Peak intensity 18.6 cd/lm  
LEDs/each optic 1  
Light colour White  
Required components:  
F17435\_HEKLA-G2-C

