

CARMEN-50-RS-C

~12° spot beam. Assembly with holder C compatible with LEDiL HEKLA.

SPECIFICATION:

Dimensions	Ø 50.0 mm
Height	25.5 mm
Fastening	socket
ROHS compliant	yes ⓘ



MATERIALS:

Component	Type	Material	Colour	Finish
CARMEN-50-RS	Single lens	PMMA	clear	
CARMEN-50-HLD-C	Holder	PC	black	





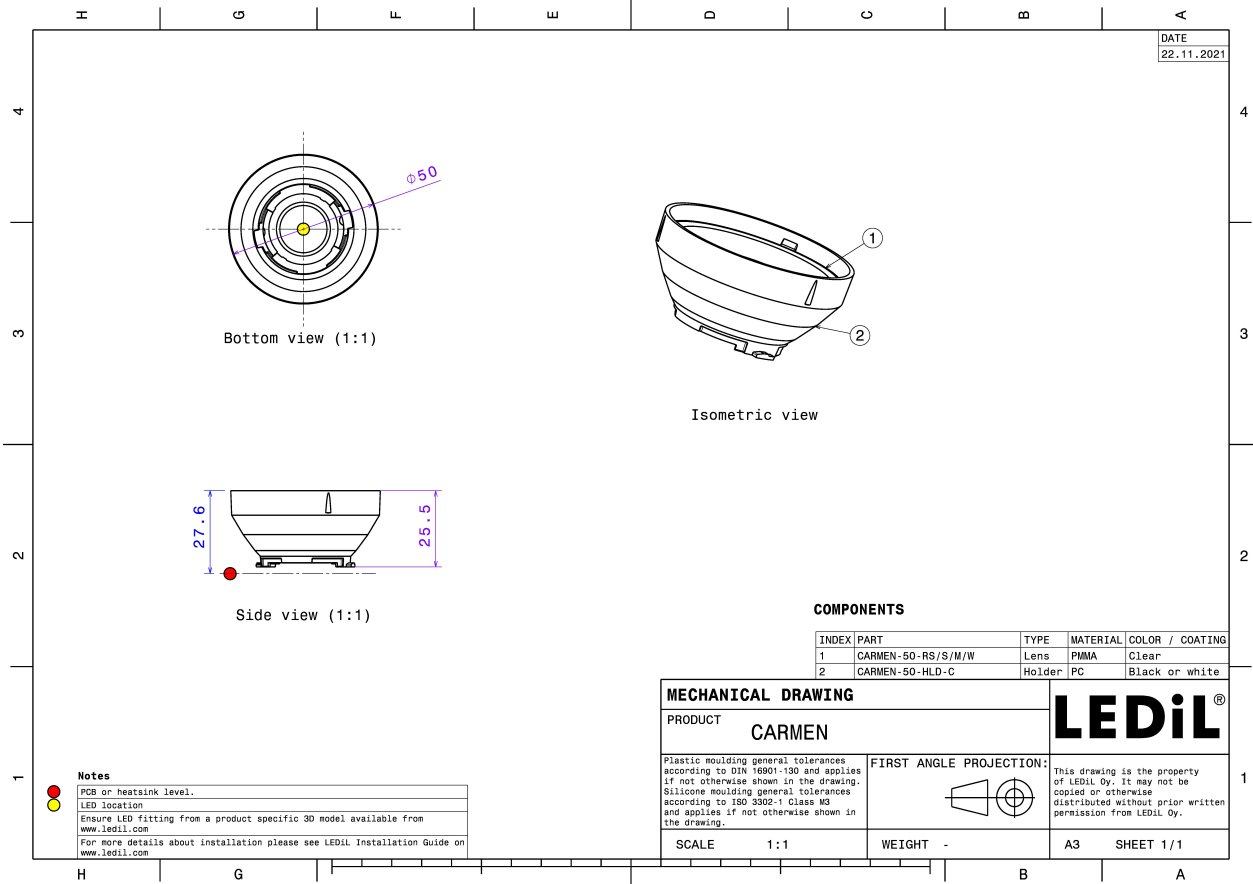



ORDERING INFORMATION:

Component	Type	Qty in box	MOQ	MPQ	Box weight (kg)
CP16106_CARMEN-50-RS-C » Box size: 476 x 273 x 292 mm	Single lens	308	112	28	7.2

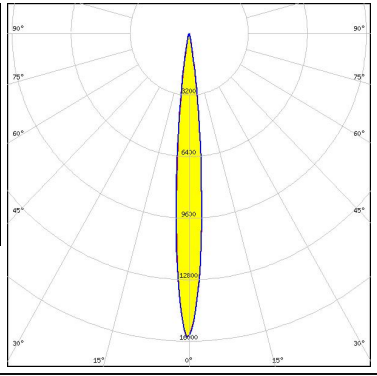

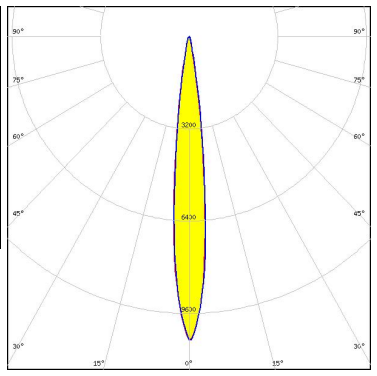
See also our general installation guide: www.ledil.com/installation_guide

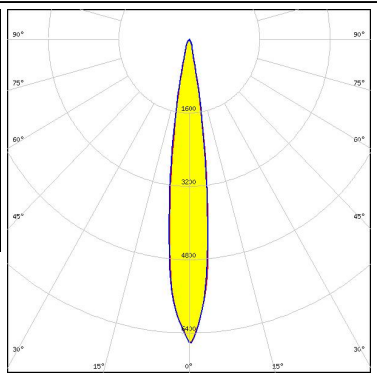
OPTICAL RESULTS (MEASURED):

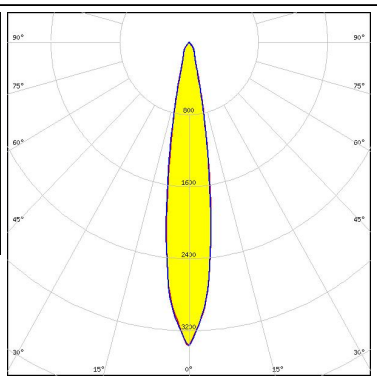
<p></p> <p>LED V4 HD Gen 7</p> <p>FWHM / FWTM 10.0° / 19.0°</p> <p>Efficiency 71 %</p> <p>Peak intensity 16 cd/lm</p> <p>LEDs/each optic 1</p> <p>Light colour White</p> <p>Required components: F15253_HEKLA-SOCKET-A</p>		
<p></p> <p>LED V6 HD Gen 7</p> <p>FWHM / FWTM 12.0° / 22.0°</p> <p>Efficiency 68 %</p> <p>Peak intensity 10.6 cd/lm</p> <p>LEDs/each optic 1</p> <p>Light colour White</p> <p>Required components: F15255_HEKLA-SOCKET-C</p>		
<p></p> <p>LED V9 HD Gen7</p> <p>FWHM / FWTM 15.0° / 26.0°</p> <p>Efficiency 64 %</p> <p>Peak intensity 6.7 cd/lm</p> <p>LEDs/each optic 1</p> <p>Light colour White</p> <p>Required components: F15859_HEKLA-SOCKET-I</p>		
<p></p> <p>LED VERO13</p> <p>FWHM / FWTM 17.0° / 33.0°</p> <p>Efficiency 51 %</p> <p>Peak intensity 3.4 cd/lm</p> <p>LEDs/each optic 1</p> <p>Light colour White</p> <p>Required components: C16142_HEKLA-SOCKET-K</p>		

OPTICAL RESULTS (MEASURED):

bridgelux.

LED Vesta TW 6mm DP
 FWHM / FWTM 11.0° / 21.0°
 Efficiency 59 %
 Peak intensity 9.9 cd/lm
 LEDs/each optic 1
 Light colour White

Required components:
 C16142_HEKLA-SOCKET-K
 Bender Wirth: 504 Typ L8



bridgelux.

LED Vesta TW 9mm (9W) DP
 FWHM / FWTM 15.0° / 28.0°
 Efficiency 54 %
 Peak intensity 5.1 cd/lm
 LEDs/each optic 1
 Light colour White

Required components:
 C16142_HEKLA-SOCKET-K
 Bender Wirth: 489 Typ L8



CITIZEN

LED CLL02x/CLU02x (LES10)
 FWHM / FWTM 16.0° / 29.0°
 Efficiency 63 %
 Peak intensity 5.6 cd/lm
 LEDs/each optic 1
 Light colour White

Required components:
 F15255_HEKLA-SOCKET-C

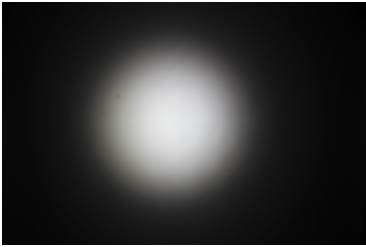

CITIZEN

LED CLU700/701/702/703
 FWHM / FWTM 11.0° / 21.0°
 Efficiency 67 %
 Peak intensity 11.8 cd/lm
 LEDs/each optic 1
 Light colour White

Required components:
 F15255_HEKLA-SOCKET-C



OPTICAL RESULTS (MEASURED):

CITIZEN

LED CLU710/711
 FWHM / FWTM 14.0° / 27.0°
 Efficiency 62 %
 Peak intensity 6.4 cd/lm
 LEDs/each optic 1
 Light colour White
 Required components:
 F15859_HEKLA-SOCKET-I

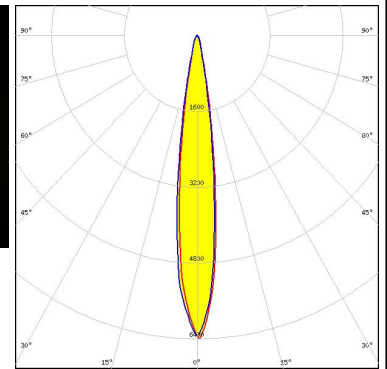

CITIZEN

LED CLU7A2/7A3
 FWHM / FWTM 9.0° / 18.0°
 Efficiency 72 %
 Peak intensity 18.5 cd/lm
 LEDs/each optic 1
 Light colour White
 Required components:
 F15255_HEKLA-SOCKET-C

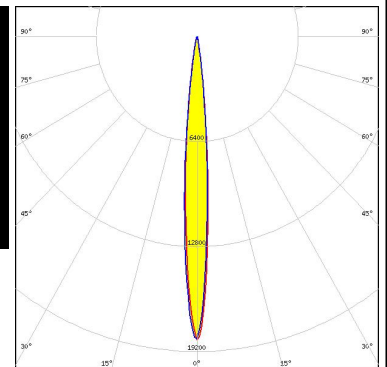

CITIZEN

LED CLU7B2
 FWHM / FWTM 8.0° / 17.0°
 Efficiency 71 %
 Peak intensity 20 cd/lm
 LEDs/each optic 1
 Light colour White
 Required components:
 F15255_HEKLA-SOCKET-C

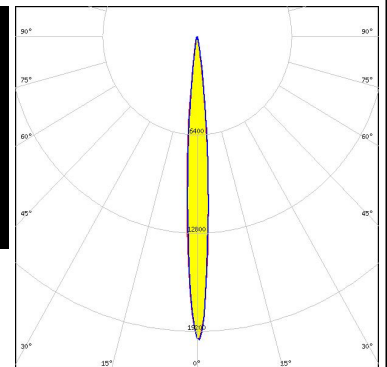
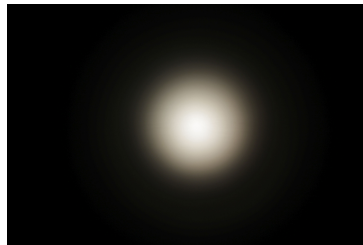

LED CMA1516
 FWHM / FWTM 16.0° / 29.0°
 Efficiency 65 %
 Peak intensity 5.9 cd/lm
 LEDs/each optic 1
 Light colour White
 Required components:
 F15256_HEKLA-SOCKET-D

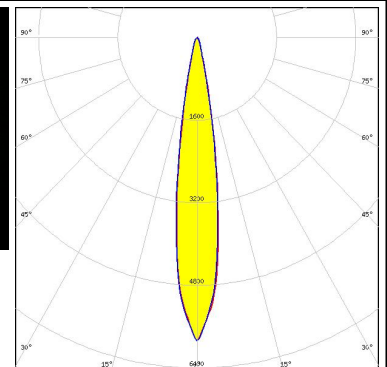
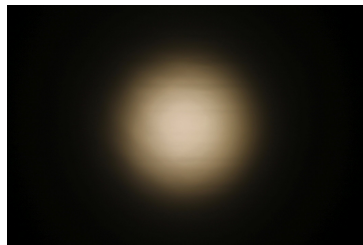

OPTICAL RESULTS (MEASURED):



LED CMT14xx
 FWHM / FWTM 16.0° / 30.0°
 Efficiency 42 %
 Peak intensity 3.6 cd/lm
 LEDs/each optic 1
 Light colour White
 Required components:
 F15255_HEKLA-SOCKET-C

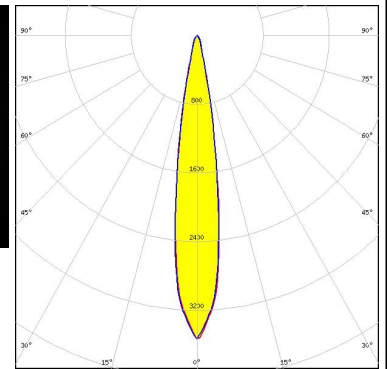
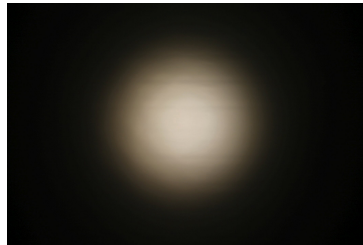

LED CXA/B 13xx
 FWHM / FWTM 12.0° / 23.0°
 Efficiency 68 %
 Peak intensity 10.6 cd/lm
 LEDs/each optic 1
 Light colour White
 Required components:
 F15956_HEKLA-SOCKET-J

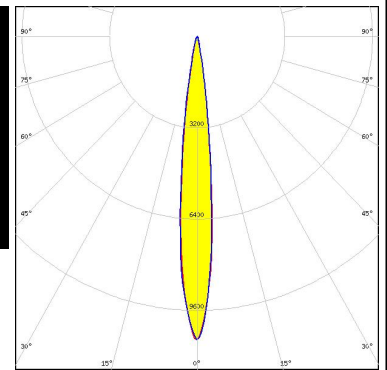
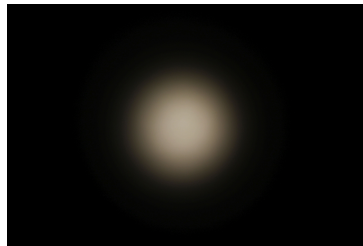

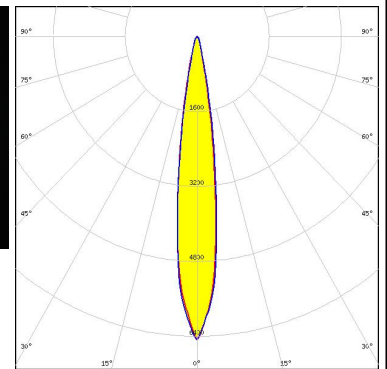

LED CXA/B 15xx
 FWHM / FWTM 15.0° / 28.0°
 Efficiency 65 %
 Peak intensity 6.5 cd/lm
 LEDs/each optic 1
 Light colour White
 Required components:
 F15256_HEKLA-SOCKET-D



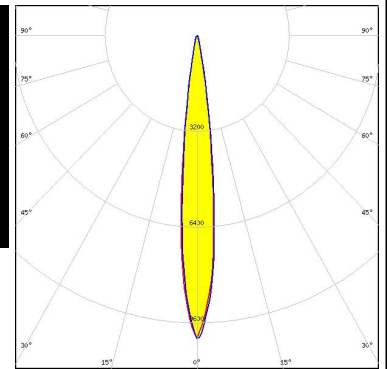

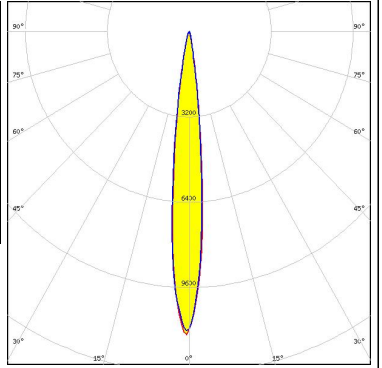
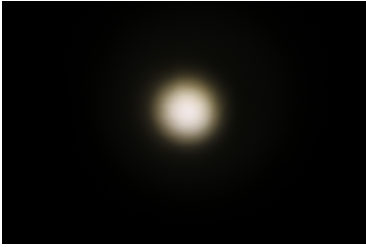
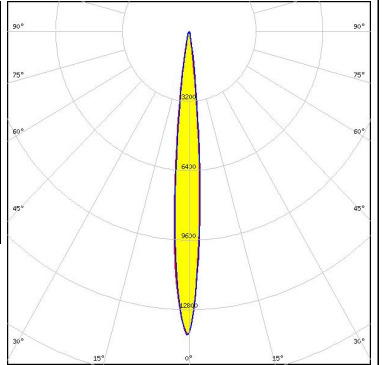
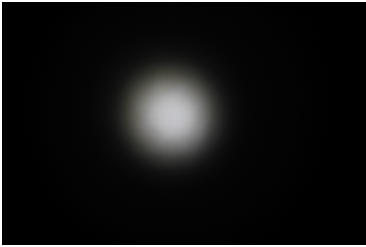
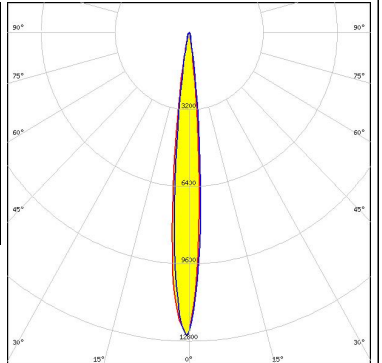

LED LUXEON CoB 1202HD
 FWHM / FWTM 12.0° / 23.0°
 Efficiency 68 %
 Peak intensity 10.1 cd/lm
 LEDs/each optic 1
 Light colour White
 Required components:
 F15848_HEKLA-SOCKET-G

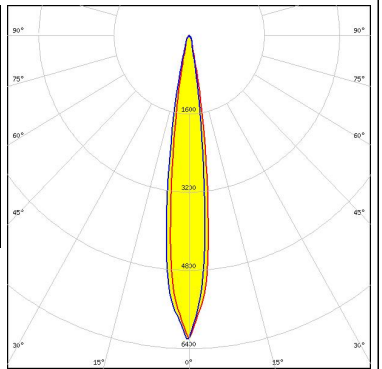



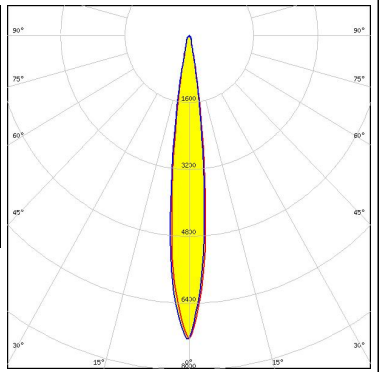
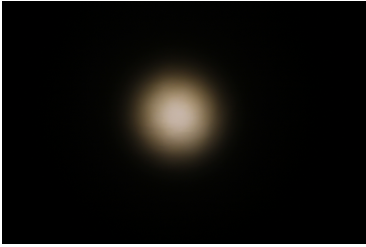
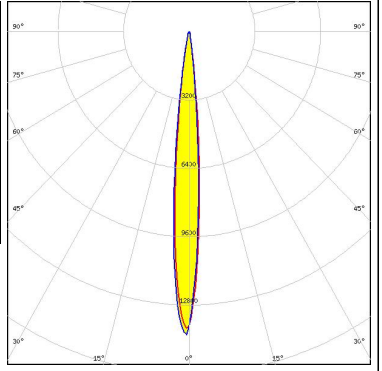

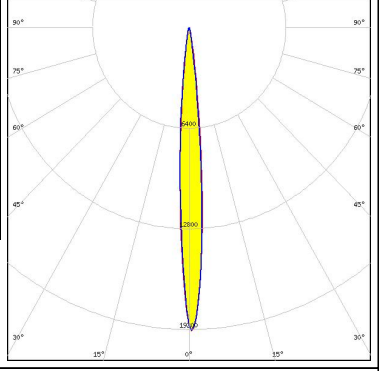
OPTICAL RESULTS (MEASURED):

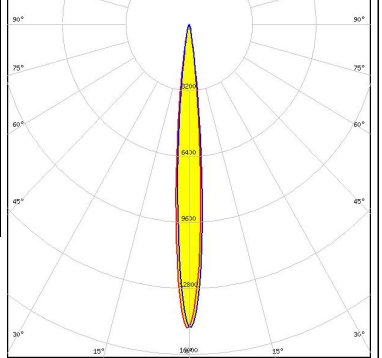
<p>LUMILEDS</p> <p>LED LUXEON CoB 1202s</p> <p>FWHM / FWTM 12.0° / 22.0°</p> <p>Efficiency 69 %</p> <p>Peak intensity 11.4 cd/lm</p> <p>LEDs/each optic 1</p> <p>Light colour White</p> <p>Required components: F15848_HEKLA-SOCKET-G</p>		
<p>LUMILEDS</p> <p>LED LUXEON CX Plus CoB - HD S01H4</p> <p>FWHM / FWTM 10.0° / 19.0°</p> <p>Efficiency 64 %</p> <p>Peak intensity 14 cd/lm</p> <p>LEDs/each optic 1</p> <p>Light colour White</p> <p>Required components: Bender Wirth: 634c Hekla</p>		
<p>LUMILEDS</p> <p>LED LUXEON CX Plus CoB - HD S02H6</p> <p>FWHM / FWTM 10.0° / 19.0°</p> <p>Efficiency 64 %</p> <p>Peak intensity 12.7 cd/lm</p> <p>LEDs/each optic 1</p> <p>Light colour White</p> <p>Required components: Bender Wirth: 634c Hekla</p>		
<p>LUMILEDS</p> <p>LED LUXEON CX Plus CoB - HD S04H9</p> <p>FWHM / FWTM 14.0° / 26.0°</p> <p>Efficiency 60 %</p> <p>Peak intensity 6.2 cd/lm</p> <p>LEDs/each optic 1</p> <p>Light colour White</p> <p>Required components: Bender Wirth: 634c Hekla</p>		

OPTICAL RESULTS (MEASURED):

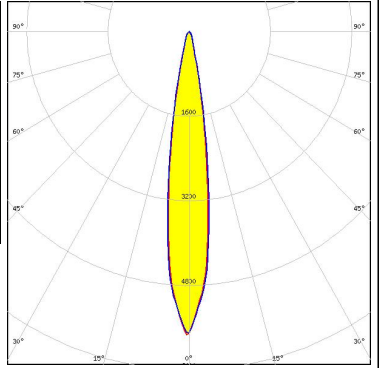
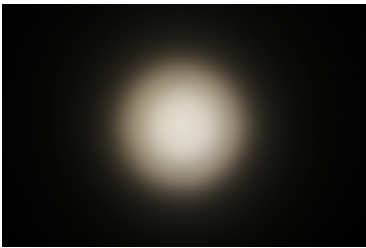
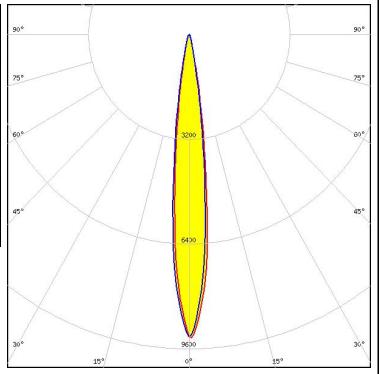
<p>LUMILEDS</p> <p>LED LUXEON CX Plus CoB M02 / M03 (Gen2)</p> <p>FWHM / FWTM 13.0° / 25.0°</p> <p>Efficiency 60 %</p> <p>Peak intensity 7.3 cd/lm</p> <p>LEDs/each optic 1</p> <p>Light colour White</p> <p>Required components: Bender Wirth: 641a Hekla</p>		
<p>LUMILEDS</p> <p>LED LUXEON CX Plus CoB S01 (Gen2)</p> <p>FWHM / FWTM 10.0° / 19.0°</p> <p>Efficiency 65 %</p> <p>Peak intensity 14.3 cd/lm</p> <p>LEDs/each optic 1</p> <p>Light colour White</p> <p>Required components: Bender Wirth: 634c Hekla</p>		
<p>LUMINUS</p> <p>LED CXM-3</p> <p>FWHM / FWTM 9.0° / 17.0°</p> <p>Efficiency 72 %</p> <p>Peak intensity 19.8 cd/lm</p> <p>LEDs/each optic 1</p> <p>Light colour White</p> <p>Required components: F15255_HEKLA-SOCKET-C</p>		
<p>LUMINUS</p> <p>LED CXM-4</p> <p>FWHM / FWTM 10.0° / 19.0°</p> <p>Efficiency 68 %</p> <p>Peak intensity 14.8 cd/lm</p> <p>LEDs/each optic 1</p> <p>Light colour White</p> <p>Required components: F15255_HEKLA-SOCKET-C</p>		

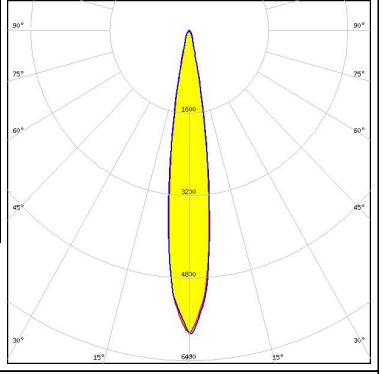
OPTICAL RESULTS (MEASURED):

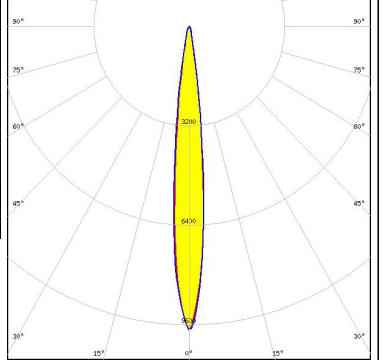
<p>LUMINUS</p> <p>LED CxM-9 (13.5x13.5) FWHM / FWTM 15.0° / 29.0° Efficiency 63 % Peak intensity 5.8 cd/lm LEDs/each optic 1 Light colour White Required components: F15255_HEKLA-SOCKET-C</p>		
<p>NICHIA</p> <p>LED COB S-Type (LES 7) FWHM / FWTM 13.0° / 24.0° Efficiency 67 % Peak intensity 9.3 cd/lm LEDs/each optic 1 Light colour White Required components: F15848_HEKLA-SOCKET-G</p>		
<p>PHILIPS</p> <p>LED Fortimo SLM L09 CoB FWHM / FWTM 15.0° / 28.0° Efficiency 64 % Peak intensity 6 cd/lm LEDs/each optic 1 Light colour White Required components: F15858_HEKLA-SOCKET-H</p>		
<p>SAMSUNG</p> <p>LED LC010C FWHM / FWTM 11.0° / 22.0° Efficiency 64 % Peak intensity 9.8 cd/lm LEDs/each optic 1 Light colour White Required components: F15848_HEKLA-SOCKET-G</p>		

OPTICAL RESULTS (MEASURED):

SAMSUNG

LED LC010C G2
 FWHM / FWTM 11.0° / 21.0°
 Efficiency 67 %
 Peak intensity 12.6 cd/lm
 LEDs/each optic 1
 Light colour White
 Required components:
 F15255_HEKLA-SOCKET-C

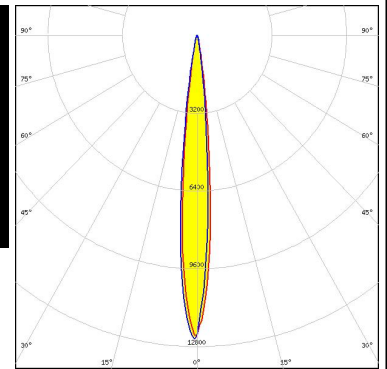
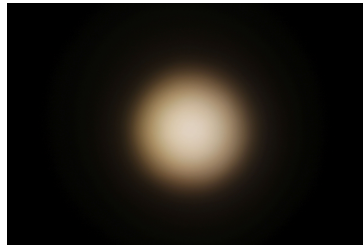

SAMSUNG

LED LC020C
 FWHM / FWTM 13.0° / 26.0°
 Efficiency 64 %
 Peak intensity 7.1 cd/lm
 LEDs/each optic 1
 Light colour White
 Required components:
 F15848_HEKLA-SOCKET-G

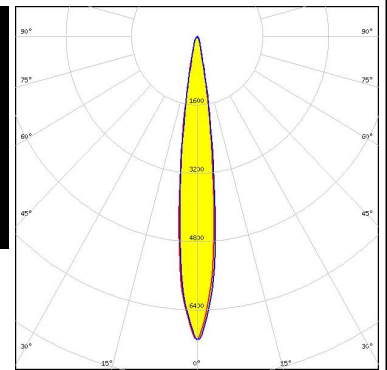

SAMSUNG

LED LC020C G2
 FWHM / FWTM 15.0° / 27.0°
 Efficiency 63 %
 Peak intensity 6.3 cd/lm
 LEDs/each optic 1
 Light colour White
 Required components:
 F15859_HEKLA-SOCKET-I

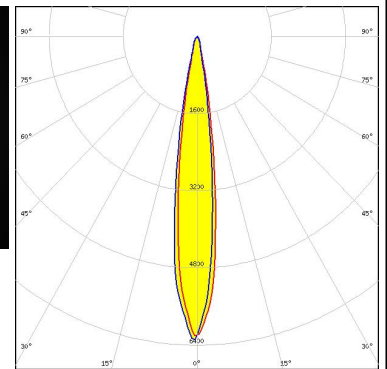

TRIDONIC

LED SLE G7 LES09
 FWHM / FWTM 15.0° / 27.0°
 Efficiency 66 %
 Peak intensity 6.5 cd/lm
 LEDs/each optic 1
 Light colour White
 Required components:
 F15255_HEKLA-SOCKET-C

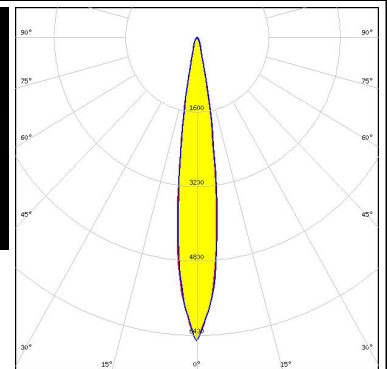
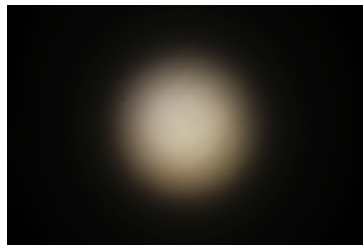

OPTICAL RESULTS (MEASURED):

TRIDONIC

LED SLE G7 LES13
 FWHM / FWTM 20.0° / 37.0°
 Efficiency 56 %
 Peak intensity 3 cd/lm
 LEDs/each optic 1
 Light colour White
 Required components:
 F15858_HEKLA-SOCKET-H

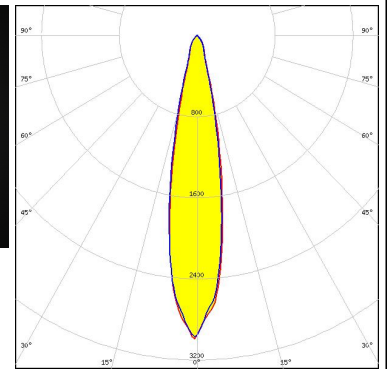

XICATO

LED XOB 6 mm
 FWHM / FWTM 11.0° / 21.0°
 Efficiency 66 %
 Peak intensity 11.1 cd/lm
 LEDs/each optic 1
 Light colour White
 Required components:
 F15255_HEKLA-SOCKET-C

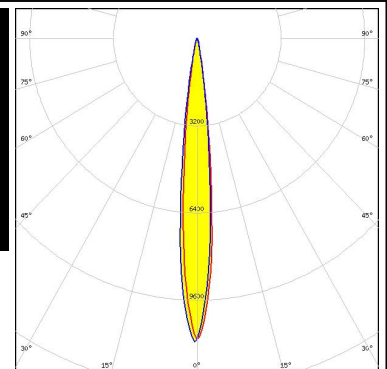

XICATO

LED XOB 9.8 mm
 FWHM / FWTM 15.0° / 28.0°
 Efficiency 63 %
 Peak intensity 6.1 cd/lm
 LEDs/each optic 1
 Light colour White
 Required components:
 F15255_HEKLA-SOCKET-C

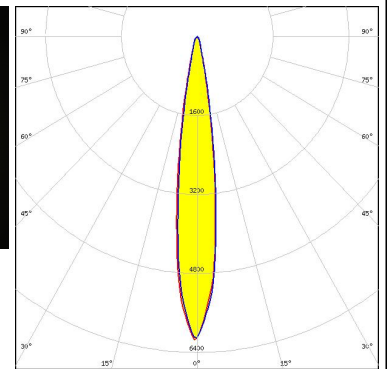





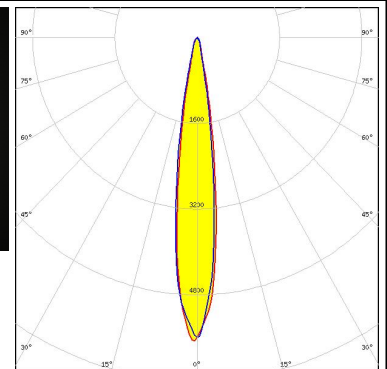
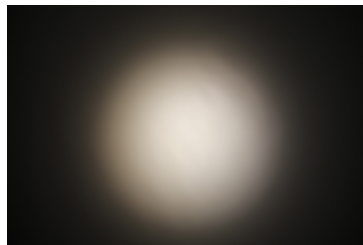

XICATO

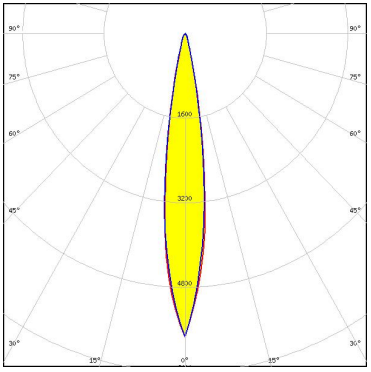
LED XTM - 9mm LES
 FWHM / FWTM 15.0° / 28.0°
 Efficiency 60 %
 Peak intensity 5.8 cd/lm
 LEDs/each optic 1
 Light colour White
 Required components:
 C15743_XTM-ADAPTER-50-B

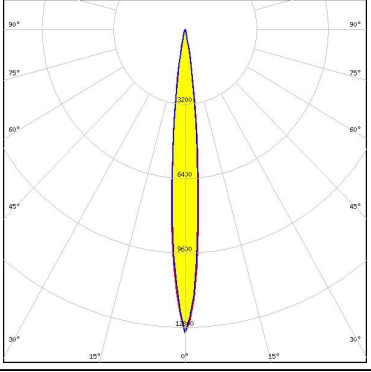

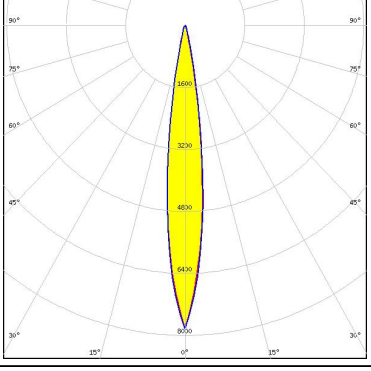
OPTICAL RESULTS (SIMULATED):

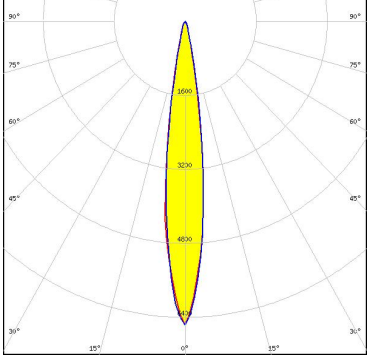
<p></p> <p>LED V10 Gen7 FWHM / FWTM 16.0° / 30.0° Efficiency 60 % Peak intensity 5.7 cd/lm LEDs/each optic 1 Light colour White Required components: F15255_HEKLA-SOCKET-C</p>	
<p></p> <p>LED V6 Gen6 FWHM / FWTM 10.0° / 21.0° Efficiency 66 % Peak intensity 13 cd/lm LEDs/each optic 1 Light colour White Required components: F15253_HEKLA-SOCKET-A</p>	
<p></p> <p>LED V8 Gen7 FWHM / FWTM 14.0° / 26.0° Efficiency 63 % Peak intensity 7.8 cd/lm LEDs/each optic 1 Light colour White Required components: F15253_HEKLA-SOCKET-A</p>	
<p></p> <p>LED VERO10 FWHM / FWTM 15.0° / 27.0° Efficiency 61 % Peak intensity 6.7 cd/lm LEDs/each optic 1 Light colour White Required components: F15616_HEKLA-SOCKET-F</p>	

OPTICAL RESULTS (SIMULATED):



LED CHA0304
 FWHM / FWTM 8.0° / 15.0°
 Efficiency 65 %
 Peak intensity 24.3 cd/lm
 LEDs/each optic 1
 Light colour White
 Required components:
 F17435_HEKLA-G2-C

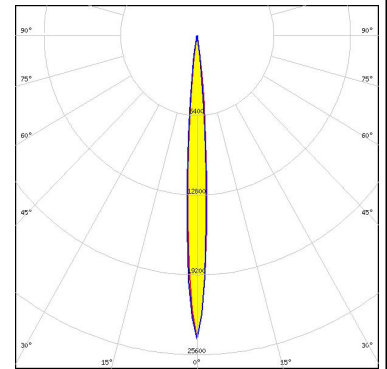

LED CHA0612
 FWHM / FWTM 10.0° / 20.0°
 Efficiency 61 %
 Peak intensity 12.1 cd/lm
 LEDs/each optic 1
 Light colour White
 Required components:
 F17435_HEKLA-G2-C

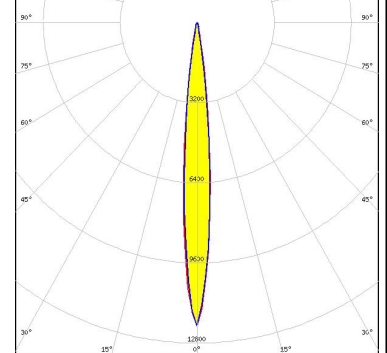

LED CHA0825
 FWHM / FWTM 14.0° / 26.0°
 Efficiency 57 %
 Peak intensity 6.8 cd/lm
 LEDs/each optic 1
 Light colour White
 Required components:
 F17438_HEKLA-G2-I

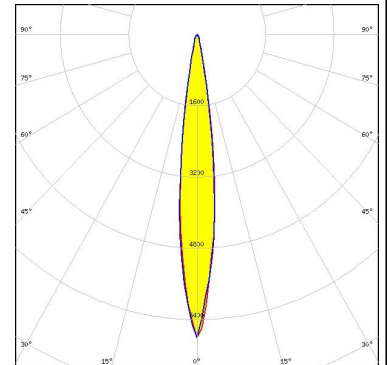

LED LUXEON CoB 1202/1203
 FWHM / FWTM 14.0° / 28.0°
 Efficiency 61 %
 Peak intensity 6.4 cd/lm
 LEDs/each optic 1
 Light colour White
 Required components:
 F15858_HEKLA-SOCKET-H

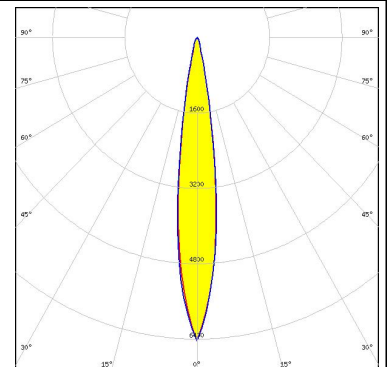

OPTICAL RESULTS (SIMULATED):

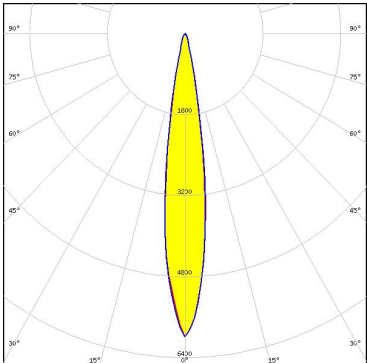
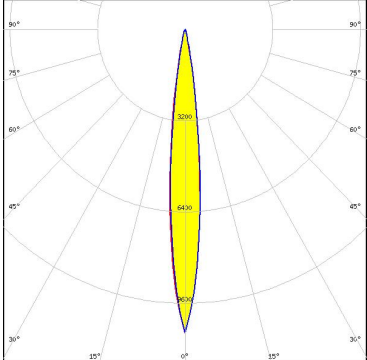
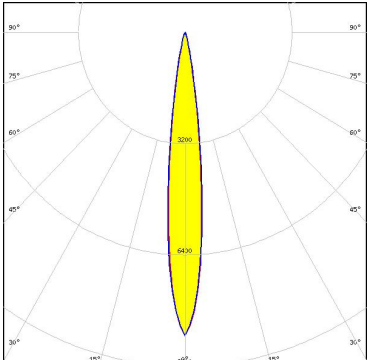
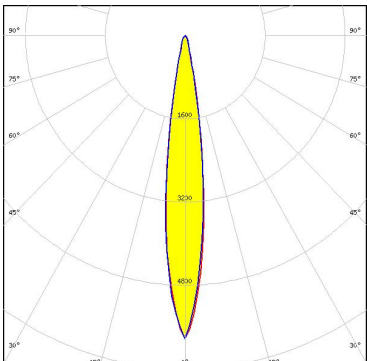
<p>LUMILEDS</p> <p>LED LUXEON CoB 1204HD</p> <p>FWHM / FWTM 16.0° / 28.0°</p> <p>Efficiency 61 %</p> <p>Peak intensity 6 cd/lm</p> <p>LEDs/each optic 1</p> <p>Light colour White</p> <p>Required components: F15858_HEKLA-SOCKET-H</p>	
<p>LUMINUS</p> <p>LED CxM-6 (13.5x13.5)</p> <p>FWHM / FWTM 12.0° / 23.0°</p> <p>Efficiency 65 %</p> <p>Peak intensity 10.6 cd/lm</p> <p>LEDs/each optic 1</p> <p>Light colour White</p> <p>Required components: F15255_HEKLA-SOCKET-C</p>	
<p>NICHIA</p> <p>LED COB S-Type (LES 6)</p> <p>FWHM / FWTM 13.0° / 25.0°</p> <p>Efficiency 63 %</p> <p>Peak intensity 8.7 cd/lm</p> <p>LEDs/each optic 1</p> <p>Light colour White</p> <p>Required components: F15848_HEKLA-SOCKET-G</p>	
<p>OSRAM Opto Semiconductors</p> <p>LED Soleriq S9</p> <p>FWHM / FWTM 15.0° / 28.0°</p> <p>Efficiency 59 %</p> <p>Peak intensity 5.8 cd/lm</p> <p>LEDs/each optic 1</p> <p>Light colour White</p> <p>Required components: F15255_HEKLA-SOCKET-C</p>	

OPTICAL RESULTS (SIMULATED):

PHILIPS

LED Fortimo SLM L06 CoB
 FWHM / FWTM 10.0° / 22.0°
 Efficiency 53 %
 Peak intensity 9.6 cd/lm
 LEDs/each optic 1
 Light colour White
 Required components:
 F15858_HEKLA-SOCKET-H

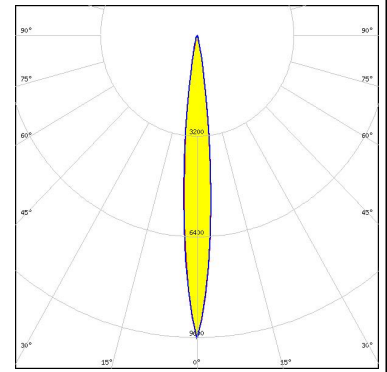

SAMSUNG

LED LC003D / LC006D / LC009D / LC013D
 FWHM / FWTM 16.0° / 30.0°
 Efficiency 58 %
 Peak intensity 5.2 cd/lm
 LEDs/each optic 1
 Light colour White
 Required components:
 F17435_HEKLA-G2-C

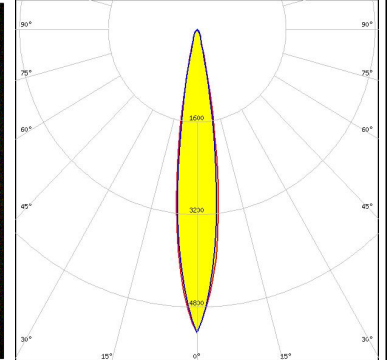

SAMSUNG

LED LC003D / LC006D / LC009D / LC013D
 FWHM / FWTM 16.0° / 30.0°
 Efficiency 58 %
 Peak intensity 5.3 cd/lm
 LEDs/each optic 1
 Light colour White
 Required components:
 F17435_HEKLA-G2-C

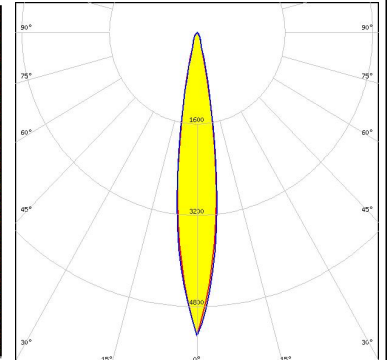
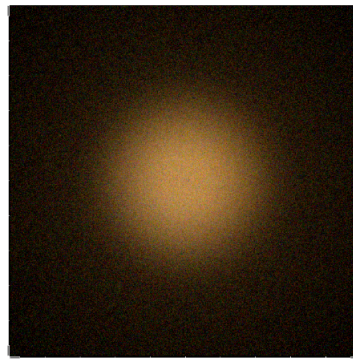

SAMSUNG

LED LC010C
 FWHM / FWTM 12.0° / 22.0°
 Efficiency 64 %
 Peak intensity 11.2 cd/lm
 LEDs/each optic 1
 Light colour White
 Required components:
 F17435_HEKLA-G2-C

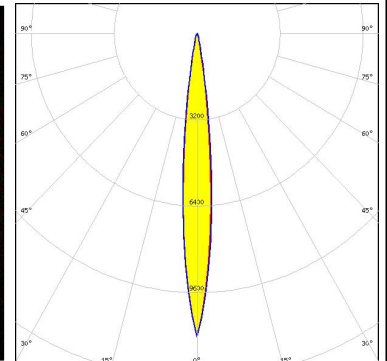

OPTICAL RESULTS (SIMULATED):

SAMSUNG

LED LH231B
 FWHM / FWTM 15.0° / 28.0°
 Efficiency 58 %
 Peak intensity 6 cd/lm
 LEDs/each optic 7
 Light colour White
 Required components:
 F15255_HEKLA-SOCKET-C

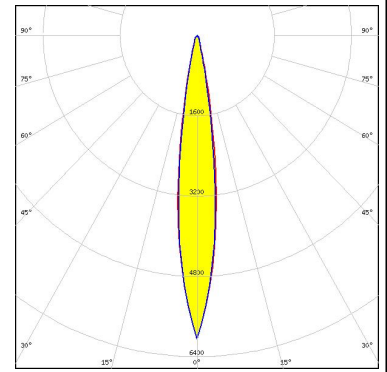

SEOUL SEMICONDUCTOR

LED MJT COB LES 6
 FWHM / FWTM 11.0° / 21.0°
 Efficiency 65 %
 Peak intensity 12.7 cd/lm
 LEDs/each optic 1
 Light colour White
 Required components:
 F17435_HEKLA-G2-C

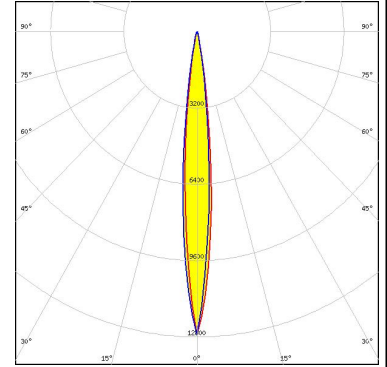

SEOUL SEMICONDUCTOR

LED MJT COB LES 9.8
 FWHM / FWTM 16.0° / 30.0°
 Efficiency 60 %
 Peak intensity 5.3 cd/lm
 LEDs/each optic 1
 Light colour White
 Required components:
 F17435_HEKLA-G2-C

