

## CARMEN-50-S-C

~24° spot beam. Assembly with holder C compatible with LEDiL HEKLA.

### SPECIFICATION:

Dimensions	Ø 50.0 mm
Height	25.5 mm
Fastening	socket
ROHS compliant	yes ⓘ



### MATERIALS:

Component	Type	Material	Colour	Finish
CARMEN-50-S	Single lens	PMMA	clear	
CARMEN-50-HLD-C	Holder	PC	black	

### ORDERING INFORMATION:



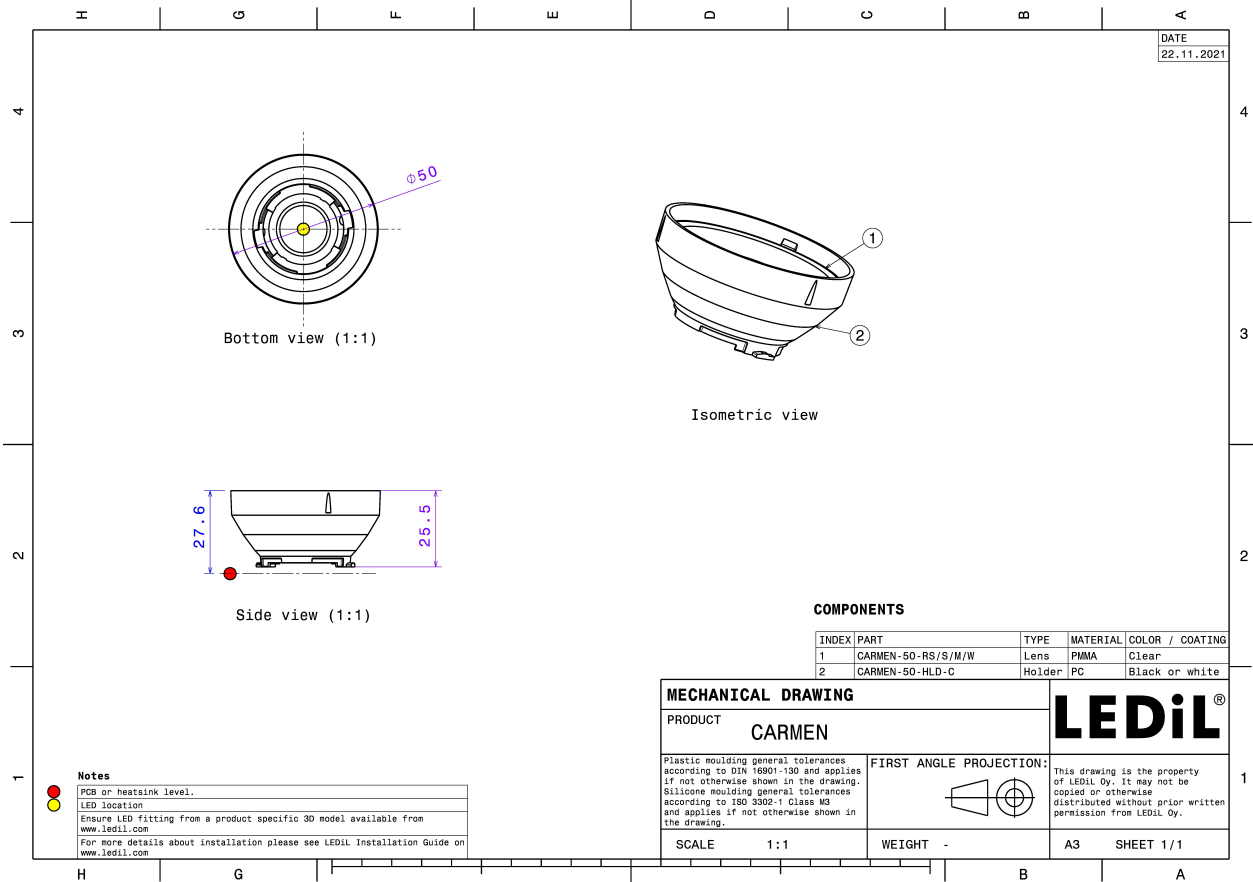





Component	Type	Qty in box	MOQ	MPQ	Box weight (kg)
CP16107_CARMEN-50-S-C » Box size: 476 x 273 x 292 mm	Single lens	308	112	28	6.9

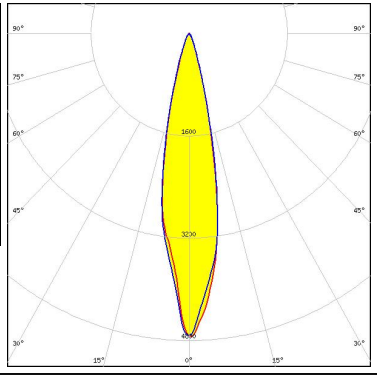

See also our general installation guide: [www.ledil.com/installation\\_guide](http://www.ledil.com/installation_guide)

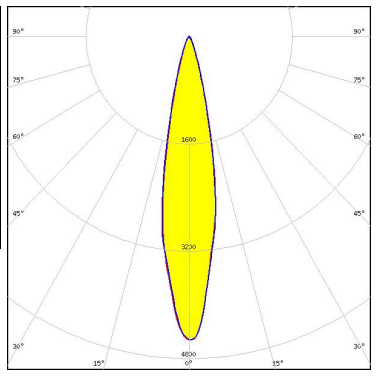

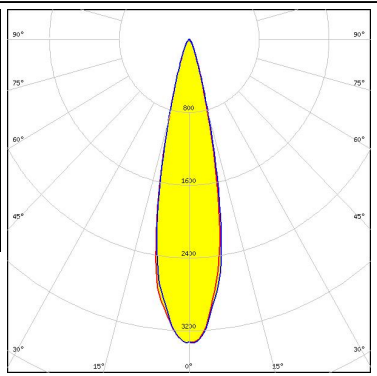
#### OPTICAL RESULTS (MEASURED):

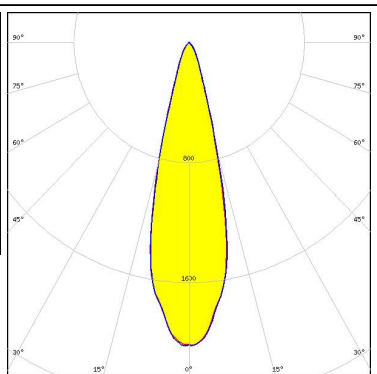
<p></p> <p>LED V4 HD Gen 7</p> <p>FWHM / FWTM 21.0° / 38.0°</p> <p>Efficiency 79 %</p> <p>Peak intensity 4.7 cd/lm</p> <p>LEDs/each optic 1</p> <p>Light colour White</p> <p>Required components: F15253_HEKLA-SOCKET-A</p>		
<p></p> <p>LED V6 HD Gen 7</p> <p>FWHM / FWTM 20.0° / 38.0°</p> <p>Efficiency 73 %</p> <p>Peak intensity 4.5 cd/lm</p> <p>LEDs/each optic 1</p> <p>Light colour White</p> <p>Required components: F15255_HEKLA-SOCKET-C</p>		
<p></p> <p>LED V9 HD Gen7</p> <p>FWHM / FWTM 23.0° / 40.0°</p> <p>Efficiency 65 %</p> <p>Peak intensity 3.3 cd/lm</p> <p>LEDs/each optic 1</p> <p>Light colour White</p> <p>Required components: F15859_HEKLA-SOCKET-I</p>		
<p></p> <p>LED VERO13</p> <p>FWHM / FWTM 27.0° / 46.0°</p> <p>Efficiency 53 %</p> <p>Peak intensity 2 cd/lm</p> <p>LEDs/each optic 1</p> <p>Light colour White</p> <p>Required components: C16142_HEKLA-SOCKET-K</p>		

#### OPTICAL RESULTS (MEASURED):

**bridgelux.**

LED Vesta TW 6mm DP  
 FWHM / FWTM 15.0° / 31.0°  
 Efficiency 63 %  
 Peak intensity 5.7 cd/m  
 LEDs/each optic 1  
 Light colour White

Required components:  
 C16142\_HEKLA-SOCKET-K  
 Bender Wirth: 504 Typ L8



**bridgelux.**

LED Vesta TW 9mm (9W) DP  
 FWHM / FWTM 22.0° / 37.0°  
 Efficiency 55 %  
 Peak intensity 3.2 cd/m  
 LEDs/each optic 1  
 Light colour White

Required components:  
 C16142\_HEKLA-SOCKET-K  
 Bender Wirth: 489 Typ L8



**CITIZEN**

LED CLL02x/CLU02x (LES10)  
 FWHM / FWTM 24.0° / 42.0°  
 Efficiency 66 %  
 Peak intensity 3.1 cd/m  
 LEDs/each optic 1  
 Light colour White

Required components:  
 F15255\_HEKLA-SOCKET-C



**CITIZEN**

LED CLU700/701/702/703  
 FWHM / FWTM 19.0° / 35.0°  
 Efficiency 73 %  
 Peak intensity 5.3 cd/m  
 LEDs/each optic 1  
 Light colour White

Required components:  
 F15255\_HEKLA-SOCKET-C





#### OPTICAL RESULTS (MEASURED):

#### CITIZEN

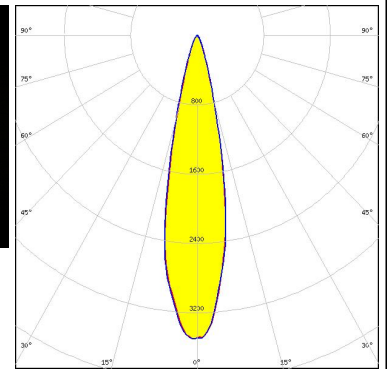
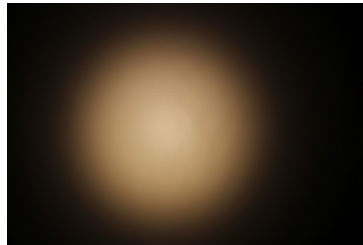
LED CLU710/711  
 FWHM / FWTM 22.0° / 39.0°  
 Efficiency 65 %  
 Peak intensity 3.5 cd/lm  
 LEDs/each optic 1  
 Light colour White  
 Required components:  
 F15859\_HEKLA-SOCKET-I

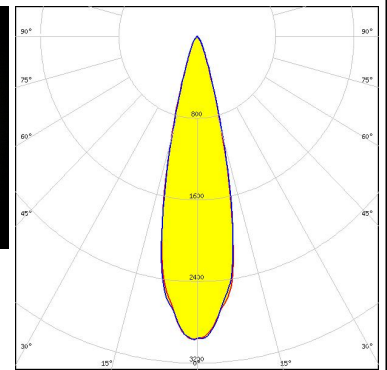
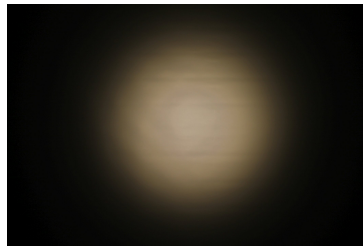

LED CMA1516  
 FWHM / FWTM 25.0° / 43.0°  
 Efficiency 68 %  
 Peak intensity 3 cd/lm  
 LEDs/each optic 1  
 Light colour White  
 Required components:  
 F15256\_HEKLA-SOCKET-D





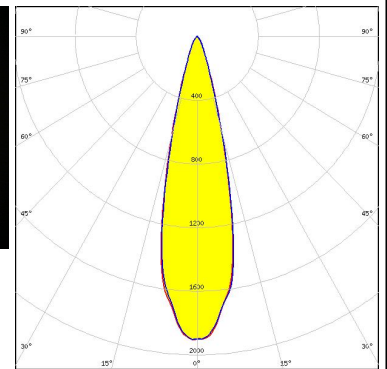
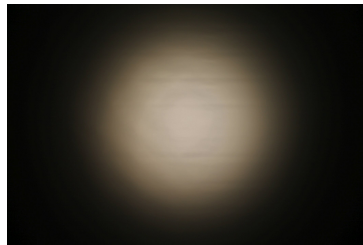

LED CMT14xx  
 FWHM / FWTM 25.0° / 43.0°  
 Efficiency 44 %  
 Peak intensity 1.9 cd/lm  
 LEDs/each optic 1  
 Light colour White  
 Required components:  
 F15255\_HEKLA-SOCKET-C

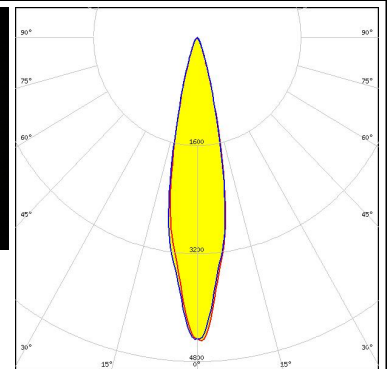

LED CXA/B 13xx  
 FWHM / FWTM 21.0° / 39.0°  
 Efficiency 76 %  
 Peak intensity 4.5 cd/lm  
 LEDs/each optic 1  
 Light colour White  
 Required components:  
 F15956\_HEKLA-SOCKET-J

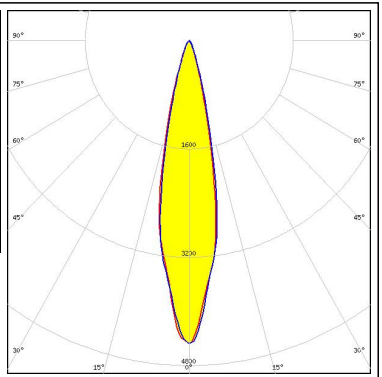

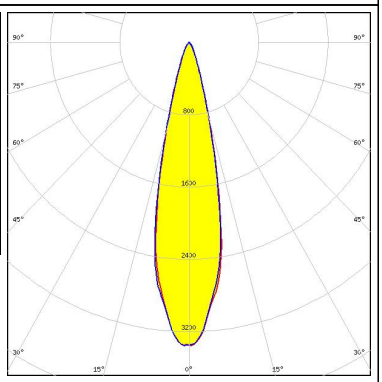
#### OPTICAL RESULTS (MEASURED):

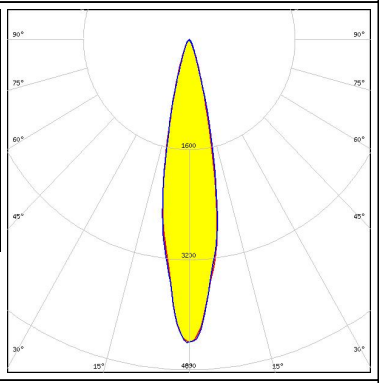
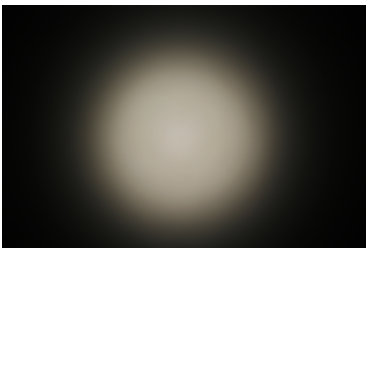
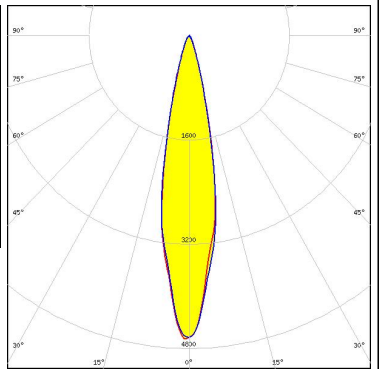
<p><b>CREE</b> LEDs</p> <p>LED CXA/B 13xx            FWHM / FWTM 22.0° / 39.0°            Efficiency 77 %            Peak intensity 4.5 cd/m            LEDs/each optic 1            Light colour White            Required components:            F15956_HEKLA-SOCKET-J</p>		
<p><b>CREE</b> LEDs</p> <p>LED CXA/B 15xx            FWHM / FWTM 24.0° / 41.0°            Efficiency 69 %            Peak intensity 3.4 cd/m            LEDs/each optic 1            Light colour White            Required components:            F15256_HEKLA-SOCKET-D</p>		
<p><b>LUMILEDS</b></p> <p>LED LUXEON CoB 1202HD            FWHM / FWTM 21.0° / 38.0°            Efficiency 73 %            Peak intensity 4.4 cd/m            LEDs/each optic 1            Light colour White            Required components:            F15848_HEKLA-SOCKET-G</p>		
<p><b>LUMILEDS</b></p> <p>LED LUXEON CoB 1202s            FWHM / FWTM 21.0° / 38.0°            Efficiency 75 %            Peak intensity 4.7 cd/m            LEDs/each optic 1            Light colour White            Required components:            F15848_HEKLA-SOCKET-G</p>		



#### OPTICAL RESULTS (MEASURED):

##### LUMILEDS

LED LUXEON CX Plus CoB - HD S01H4  
 FWHM / FWTM 16.0° / 32.0°  
 Efficiency 68 %  
 Peak intensity 6.1 cd/lm  
 LEDs/each optic 1  
 Light colour White  
 Required components:  
 Bender Wirth: 634c Hekla

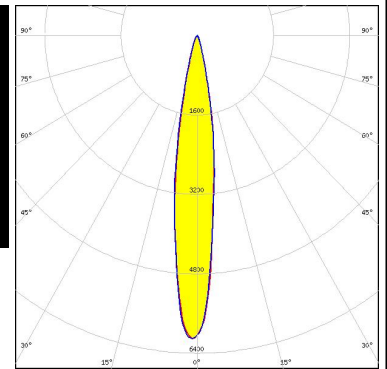
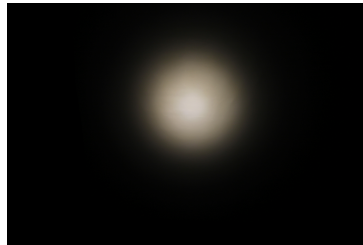

##### LUMILEDS

LED LUXEON CX Plus CoB - HD S02H6  
 FWHM / FWTM 16.0° / 32.0°  
 Efficiency 67 %  
 Peak intensity 5.9 cd/lm  
 LEDs/each optic 1  
 Light colour White  
 Required components:  
 Bender Wirth: 634c Hekla

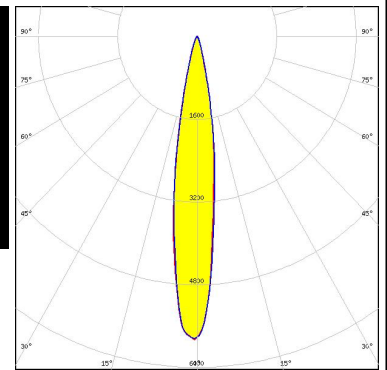

##### LUMILEDS

LED LUXEON CX Plus CoB - HD S04H9  
 FWHM / FWTM 22.0° / 38.0°  
 Efficiency 61 %  
 Peak intensity 3.4 cd/lm  
 LEDs/each optic 1  
 Light colour White  
 Required components:  
 Bender Wirth: 634c Hekla

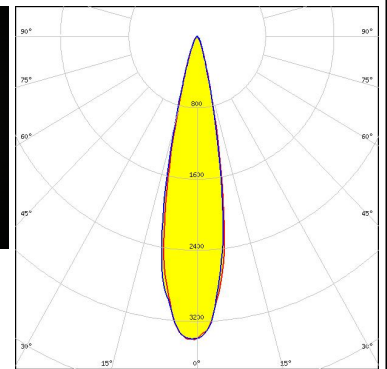
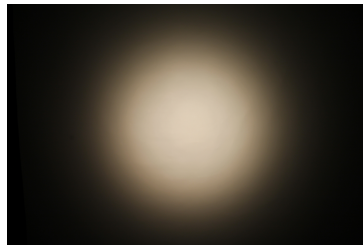



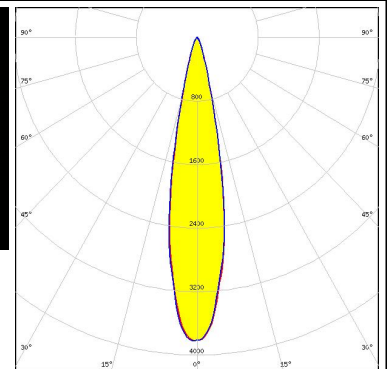
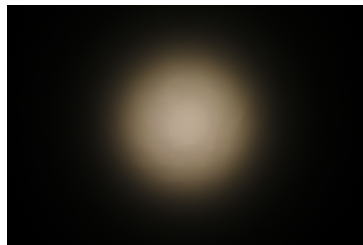

##### LUMILEDS



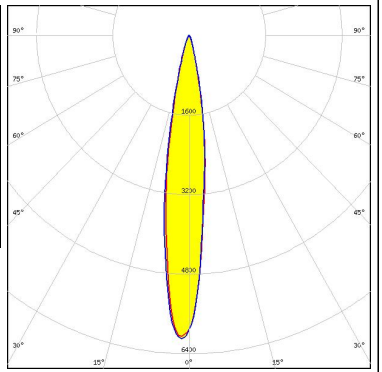
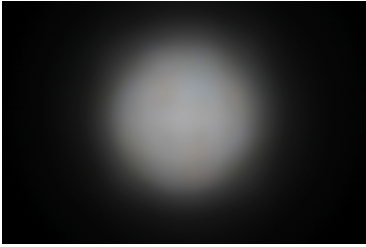
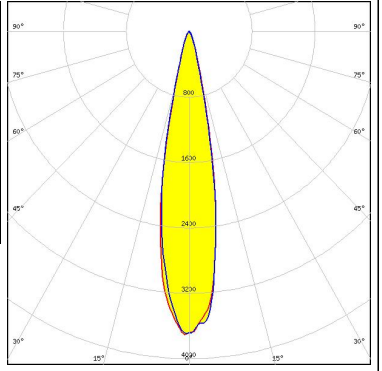

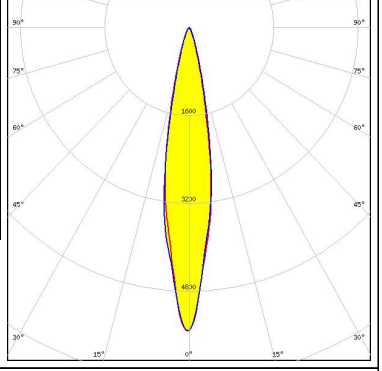

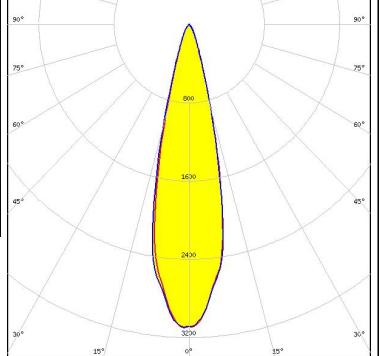
LED LUXEON CX Plus CoB M02 / M03 (Gen2)  
 FWHM / FWTM 20.0° / 36.0°  
 Efficiency 61 %  
 Peak intensity 3.8 cd/lm  
 LEDs/each optic 1  
 Light colour White  
 Required components:  
 Bender Wirth: 641a Hekla

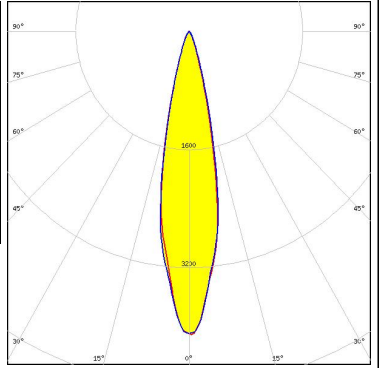

#### OPTICAL RESULTS (MEASURED):

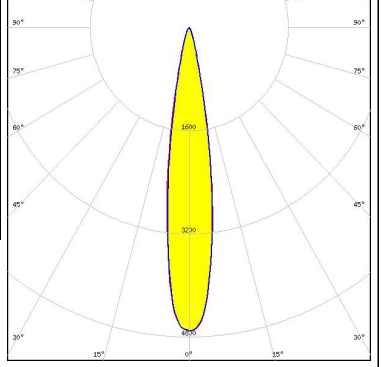
<p><b>LUMILEDS</b></p> <p>LED LUXEON CX Plus CoB S01 (Gen2)</p> <p>FWHM / FWTM 15.0° / 31.0°</p> <p>Efficiency 68 %</p> <p>Peak intensity 6.2 cd/m</p> <p>LEDs/each optic 1</p> <p>Light colour White</p> <p>Required components: Bender Wirth: 634c Hekla</p>		
<p><b>LUMINUS</b></p> <p>LED CDM-9 (Dim-To-Warm)</p> <p>FWHM / FWTM 21.0° / 35.0°</p> <p>Efficiency 57 %</p> <p>Peak intensity 3.7 cd/m</p> <p>LEDs/each optic 1</p> <p>Light colour White</p> <p>Required components: C16142_HEKLA-SOCKET-K Bender Wirth: 490 Typ L8</p>		
<p><b>LUMINUS</b></p> <p>LED CXM-4</p> <p>FWHM / FWTM 18.0° / 35.0°</p> <p>Efficiency 76 %</p> <p>Peak intensity 5.5 cd/m</p> <p>LEDs/each optic 1</p> <p>Light colour White</p> <p>Required components: F15255_HEKLA-SOCKET-C</p>		
<p><b>LUMINUS</b></p> <p>LED CxM-9 (13.5x13.5)</p> <p>FWHM / FWTM 24.0° / 42.0°</p> <p>Efficiency 67 %</p> <p>Peak intensity 3.1 cd/m</p> <p>LEDs/each optic 1</p> <p>Light colour White</p> <p>Required components: F15255_HEKLA-SOCKET-C</p>		

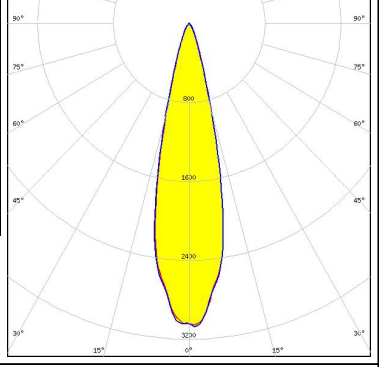
#### OPTICAL RESULTS (MEASURED):

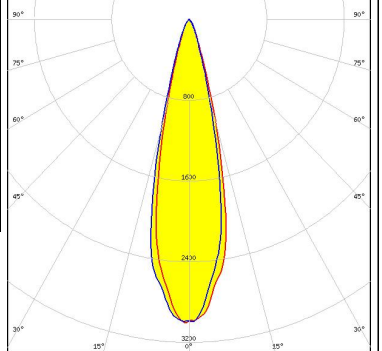
<p><b>NICHIA</b></p> <p>LED COB S-Type (LES 7)</p> <p>FWHM / FWTM 22.0° / 39.0°</p> <p>Efficiency 73 %</p> <p>Peak intensity 4.1 cd/lm</p> <p>LEDs/each optic 1</p> <p>Light colour White</p> <p>Required components: F15848_HEKLA-SOCKET-G</p>		
<p><b>NICHIA</b></p> <p>LED NJCWL024Z-V1MT: COB L-Type Tunable White</p> <p>FWHM / FWTM 17.0° / 31.0°</p> <p>Efficiency 56 %</p> <p>Peak intensity 4.7 cd/lm</p> <p>LEDs/each optic 1</p> <p>Light colour White</p> <p>Required components: C16142_HEKLA-SOCKET-K Bender Wirth: 497 Typ L8</p>		
<p><b>PHILIPS</b></p> <p>LED Fortimo SLM L09 CoB</p> <p>FWHM / FWTM 24.0° / 41.0°</p> <p>Efficiency 65 %</p> <p>Peak intensity 3.1 cd/lm</p> <p>LEDs/each optic 1</p> <p>Light colour White</p> <p>Required components: F15858_HEKLA-SOCKET-H</p>		
<p><b>SAMSUNG</b></p> <p>LED LC003D / LC006D / LC009D / LC013D</p> <p>FWHM / FWTM 25.0° / 43.0°</p> <p>Efficiency 67 %</p> <p>Peak intensity 3 cd/lm</p> <p>LEDs/each optic 1</p> <p>Light colour White</p> <p>Required components: F15255_HEKLA-SOCKET-C</p>		

#### OPTICAL RESULTS (MEASURED):

### SAMSUNG

LED LC010C G2  
 FWHM / FWTM 19.0° / 35.0°  
 Efficiency 74 %  
 Peak intensity 5.3 cd/m  
 LEDs/each optic 1  
 Light colour White  
 Required components:  
 F15255\_HEKLA-SOCKET-C

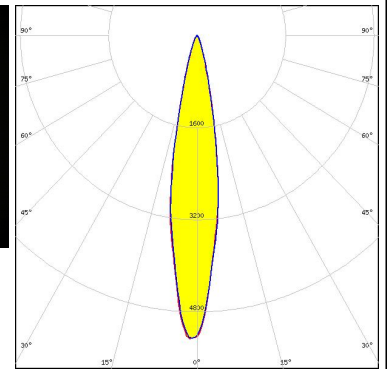

### SAMSUNG

LED LC020C G2  
 FWHM / FWTM 23.0° / 40.0°  
 Efficiency 65 %  
 Peak intensity 3.3 cd/m  
 LEDs/each optic 1  
 Light colour White  
 Required components:  
 F15859\_HEKLA-SOCKET-I

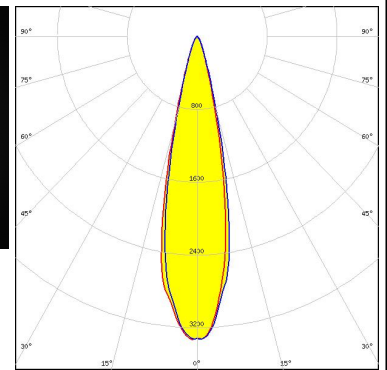

### TRIDONIC

LED SLE G7 LES09  
 FWHM / FWTM 23.0° / 41.0°  
 Efficiency 69 %  
 Peak intensity 3.5 cd/m  
 LEDs/each optic 1  
 Light colour White  
 Required components:  
 F15255\_HEKLA-SOCKET-C

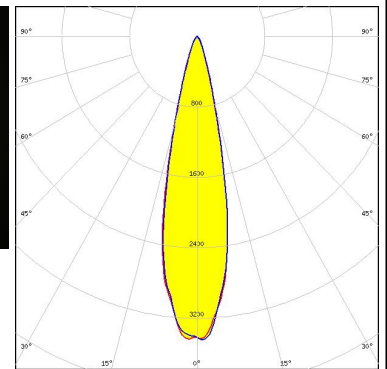
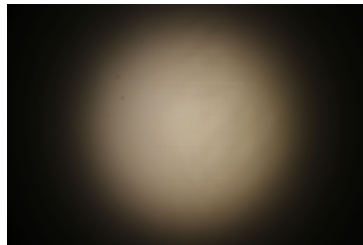

### TRIDONIC

LED SLE G7 LES13  
 FWHM / FWTM 31.0° / 51.0°  
 Efficiency 58 %  
 Peak intensity 1.8 cd/m  
 LEDs/each optic 1  
 Light colour White  
 Required components:  
 F15859\_HEKLA-SOCKET-I

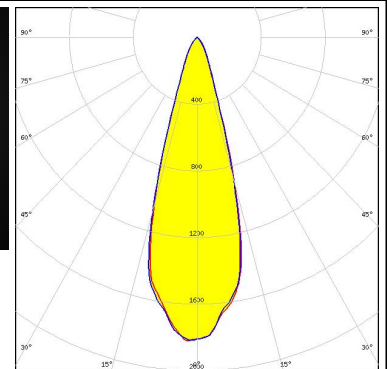
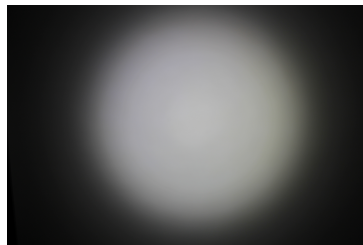



#### OPTICAL RESULTS (MEASURED):

#### XICATO

LED XOB 6 mm  
 FWHM / FWTM 19.0° / 36.0°  
 Efficiency 73 %  
 Peak intensity 4.9 cd/lm  
 LEDs/each optic 1  
 Light colour White  
 Required components:  
 F15255\_HEKLA-SOCKET-C

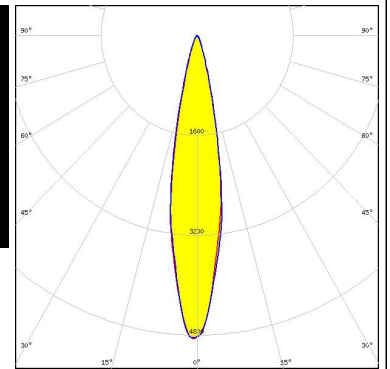





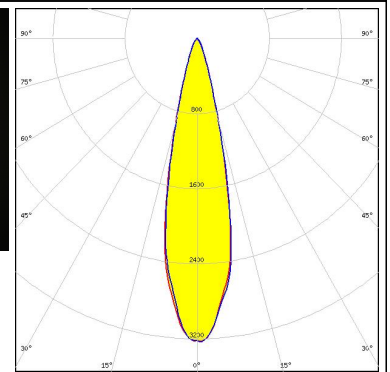
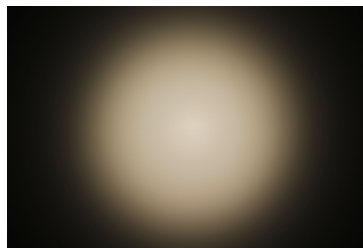

#### XICATO

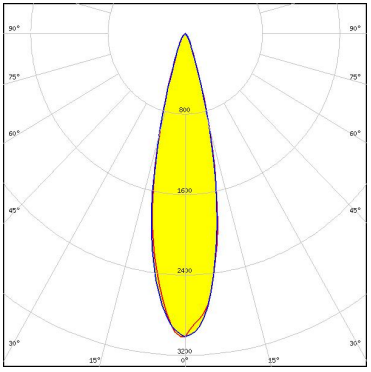
LED XOB 9.8 mm  
 FWHM / FWTM 24.0° / 42.0°  
 Efficiency 67 %  
 Peak intensity 3.2 cd/lm  
 LEDs/each optic 1  
 Light colour White  
 Required components:  
 F15255\_HEKLA-SOCKET-C

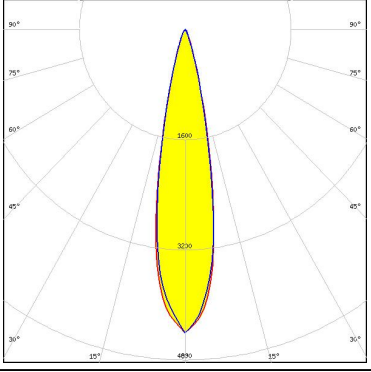

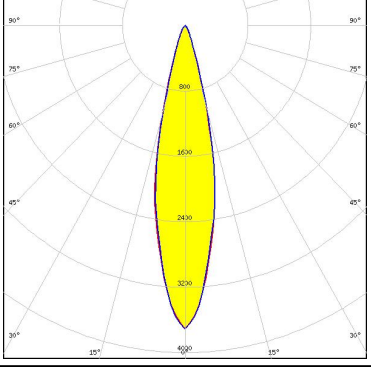
#### OPTICAL RESULTS (SIMULATED):

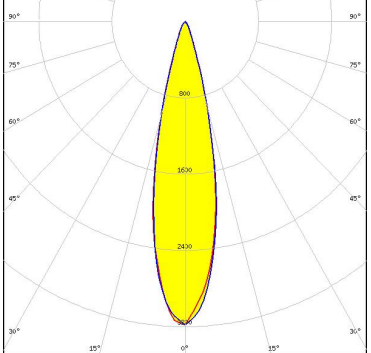
<p></p> <p>LED V10 Gen7            FWHM / FWTM 24.0° / 42.0°            Efficiency 65 %            Peak intensity 3.1 cd/lm            LEDs/each optic 1            Light colour White            Required components:            F15255_HEKLA-SOCKET-C</p>	
<p></p> <p>LED V6 Gen6            FWHM / FWTM 21.0° / 37.0°            Efficiency 71 %            Peak intensity 4.4 cd/lm            LEDs/each optic 1            Light colour White            Required components:            F15253_HEKLA-SOCKET-A</p>	
<p></p> <p>LED V8 Gen7            FWHM / FWTM 24.0° / 40.0°            Efficiency 71 %            Peak intensity 3.7 cd/lm            LEDs/each optic 1            Light colour White            Required components:            F15253_HEKLA-SOCKET-A</p>	
<p></p> <p>LED VERO10            FWHM / FWTM 24.0° / 41.0°            Efficiency 64 %            Peak intensity 3.2 cd/lm            LEDs/each optic 1            Light colour White            Required components:            F15616_HEKLA-SOCKET-F</p>	

#### OPTICAL RESULTS (SIMULATED):



LED: CHA0304  
 FWHM / FWTM: 20.0° / 33.0°  
 Efficiency: 72 %  
 Peak intensity: 5.4 cd/lm  
 LEDs/each optic: 1  
 Light colour: White  
 Required components:  
 F17435\_HEKLA-G2-C

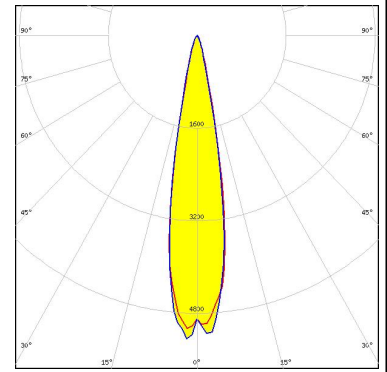

LED: CHA0612  
 FWHM / FWTM: 16.0° / 31.0°  
 Efficiency: 66 %  
 Peak intensity: 5.9 cd/lm  
 LEDs/each optic: 1  
 Light colour: White  
 Required components:  
 F17435\_HEKLA-G2-C

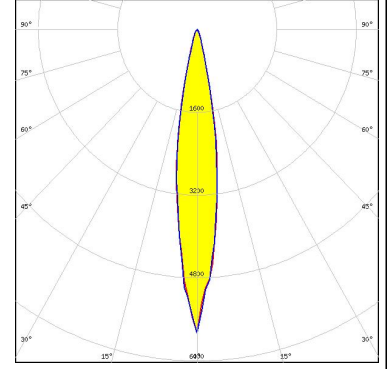

LED: CHA0825  
 FWHM / FWTM: 20.0° / 36.0°  
 Efficiency: 60 %  
 Peak intensity: 3.9 cd/lm  
 LEDs/each optic: 1  
 Light colour: White  
 Required components:  
 F17438\_HEKLA-G2-I

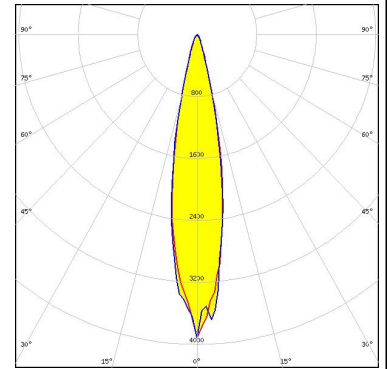

LED: COB S-Type (LES 6)  
 FWHM / FWTM: 30.0° / 50.0°  
 Efficiency: 62 %  
 Peak intensity: 2.1 cd/lm  
 LEDs/each optic: 1  
 Light colour: White  
 Required components:  
 F15848\_HEKLA-SOCKET-G

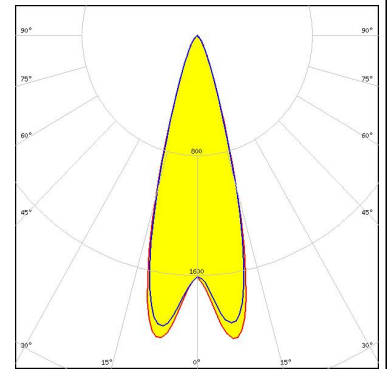

#### OPTICAL RESULTS (SIMULATED):

### SAMSUNG

LED LH231B  
FWHM / FWTM 23.0° / 42.0°  
Efficiency 63 %  
Peak intensity 3 cd/lm  
LEDs/each optic 7  
Light colour White  
Required components:  
F15255\_HEKLA-SOCKET-C

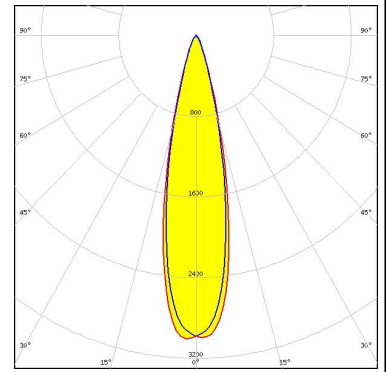

### XICATO

LED XTM - 9mm LES  
FWHM / FWTM 25.0° / 43.0°  
Efficiency 67 %  
Peak intensity 3 cd/lm  
LEDs/each optic 1  
Light colour White  
Required components:  
C15743\_XTM-ADAPTER-50-B

