

YASMEEN-50-WW-C

~60° wide beam. Assembly with holder C compatible with HEKLA sockets and connectors. Black version.

TECHNICAL SPECIFICATIONS:

Dimensions	49.9 x 49.9 mm
Height	28.1 mm
ROHS compliant	yes ⓘ



MATERIAL SPECIFICATIONS:

Component	Type	Material	Colour	Finish
YASMEEN-50-WW	Single lens	PMMA	clear	
YASMEEN-50-HLD-C	Holder	PC	black	



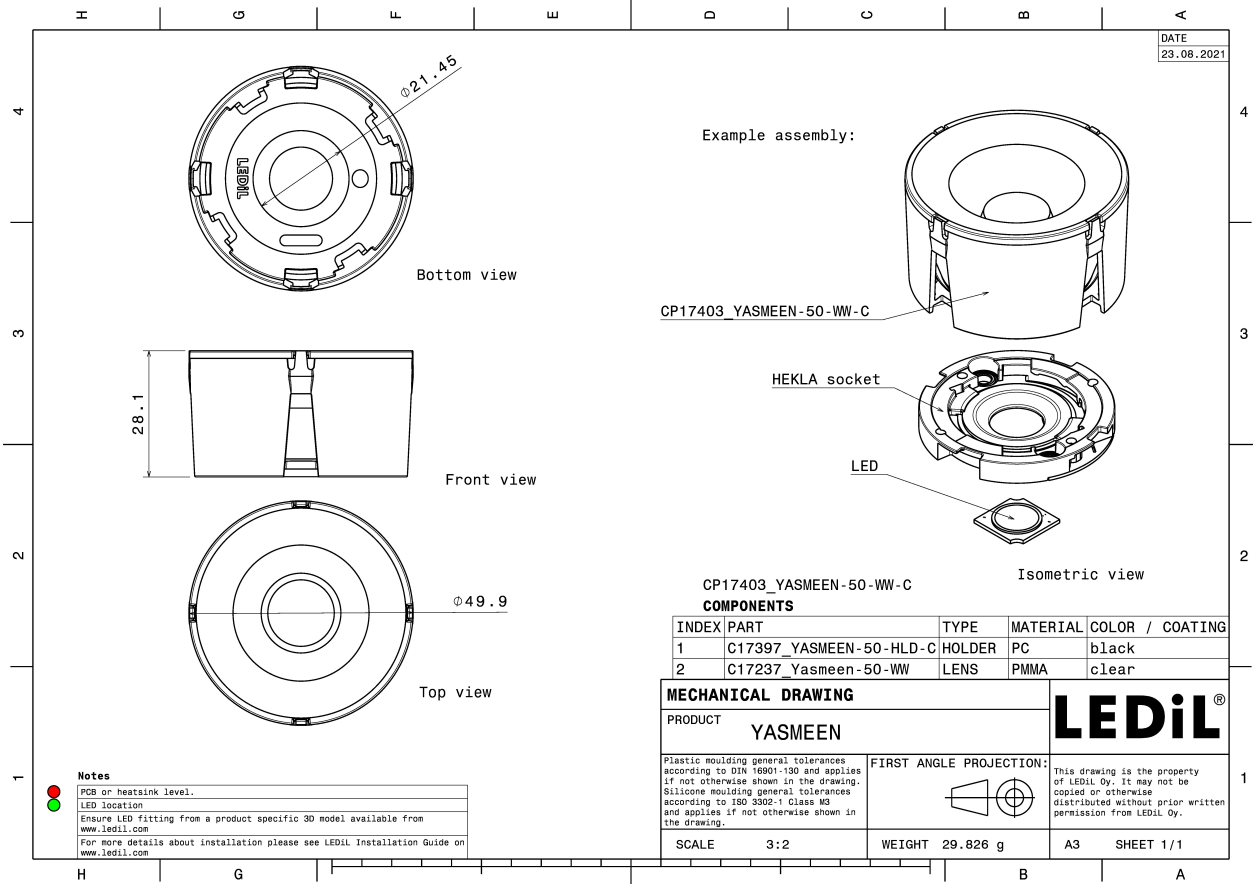

ORDERING INFORMATION:

Component		Qty in box	MOQ	MPQ	Box weight (kg)
CP17403_YASMEEN-50-WW-C	Single lens	252	112	28	9.8
» Box size: 476 x 273 x 305 mm					



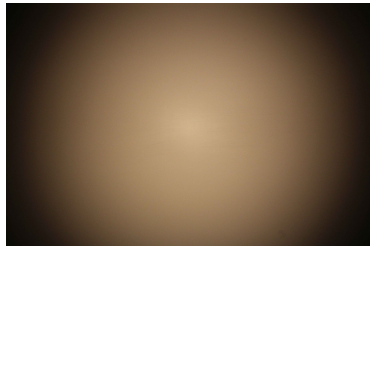
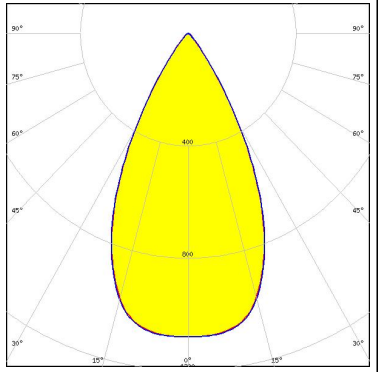

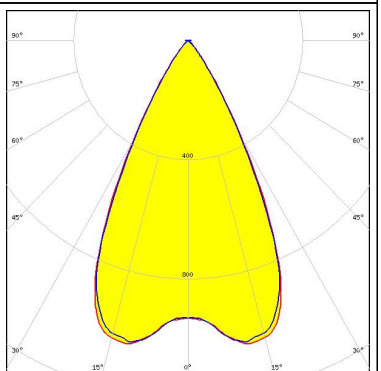

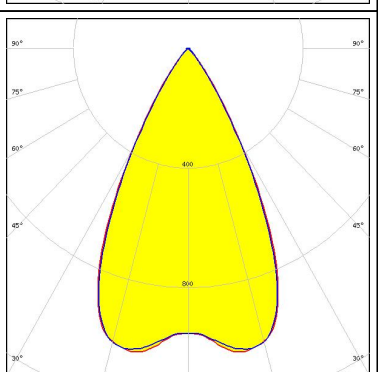
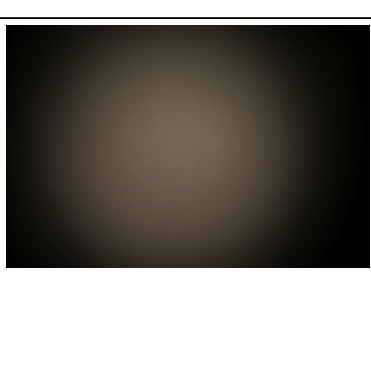
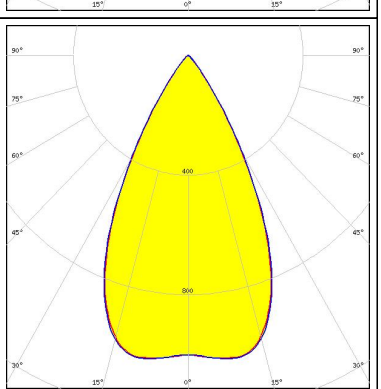

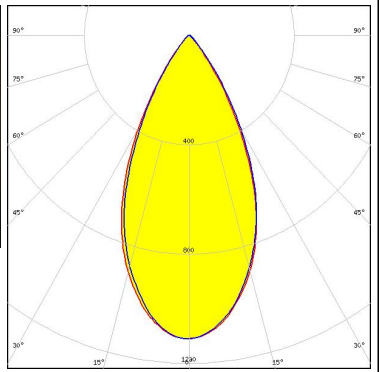

See also our general installation guide: www.ledil.com/installation_guide

PHOTOMETRIC DATA (MEASURED):

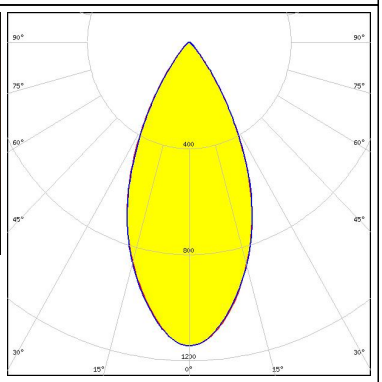
<p>bridgelux.</p> <p>LED V11 HD</p> <p>FWHM / FWTM 54.0° / 76.0°</p> <p>Efficiency 83 %</p> <p>Peak intensity 1.1 cd/lm</p> <p>LEDs/each optic 1</p> <p>Light colour White</p> <p>Required components: Bender Wirth: 633d Hekla</p>		
<p>bridgelux.</p> <p>LED V4 HD</p> <p>FWHM / FWTM 54.0° / 74.0°</p> <p>Efficiency 83 %</p> <p>Peak intensity 1.1 cd/lm</p> <p>LEDs/each optic 1</p> <p>Light colour White</p> <p>Required components: F15253_HEKLA-SOCKET-A</p>		
<p>bridgelux.</p> <p>LED V6 HD</p> <p>FWHM / FWTM 55.0° / 75.0°</p> <p>Efficiency 83 %</p> <p>Peak intensity 1 cd/lm</p> <p>LEDs/each optic 1</p> <p>Light colour White</p> <p>Required components: F15255_HEKLA-SOCKET-C</p>		
<p>bridgelux.</p> <p>LED VERO10</p> <p>FWHM / FWTM 54.0° / 76.0°</p> <p>Efficiency 82 %</p> <p>Peak intensity 1.1 cd/lm</p> <p>LEDs/each optic 1</p> <p>Light colour White</p> <p>Required components: F15616_HEKLA-SOCKET-F</p>		

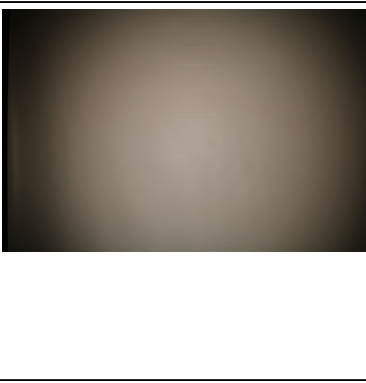
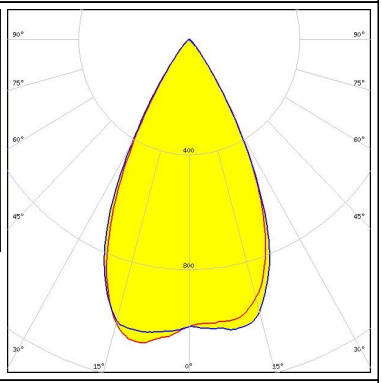
PHOTOMETRIC DATA (MEASURED):

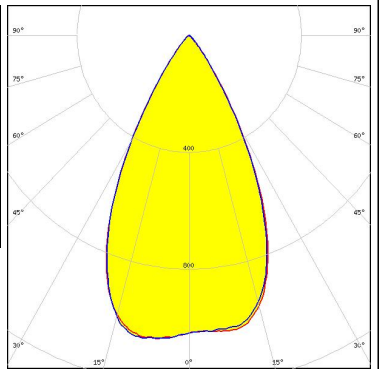
<p></p> <p>LED Vesta DTW 13mm (21W) FWHM / FWTM 51.0° / 78.0° Efficiency 79 % Peak intensity 1.1 cd/lm LEDs/each optic 1 Light colour Tunable White Required components: Bender Wirth: 632b Hekla XL</p>		
<p></p> <p>LED Vesta DTW 15mm (33W) FWHM / FWTM 49.0° / 78.0° Efficiency 79 % Peak intensity 1.1 cd/lm LEDs/each optic 1 Light colour Tunable White Required components: Bender Wirth: 632b Hekla XL</p>		
<p></p> <p>LED Vesta DTW 9mm (4W/6W/12W) FWHM / FWTM 55.0° / 76.0° Efficiency 83 % Peak intensity 1.1 cd/lm LEDs/each optic 1 Light colour White Required components: Bender Wirth: 652b Hekla</p>		
<p>CITIZEN</p> <p>LED CLL02x/CLU02x (LES10) FWHM / FWTM 54.0° / 76.0° Efficiency 83 % Peak intensity 1.1 cd/lm LEDs/each optic 1 Light colour White Required components: F17435_HEKLA-G2-C</p>		

PHOTOMETRIC DATA (MEASURED):

CITIZEN

LED CLU700/701/702
 FWHM / FWTM 55.0° / 75.0°
 Efficiency 84 %
 Peak intensity 1 cd/lm
 LEDs/each optic 1
 Light colour White
 Required components:
 F17435_HEKLA-G2-C

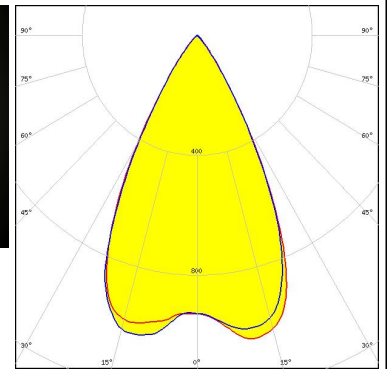
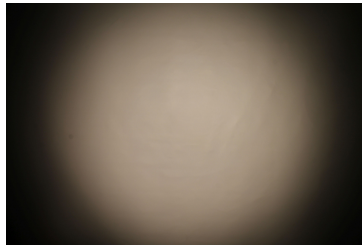

CITIZEN

LED CLU7A2 (LES 4.2mm)
 FWHM / FWTM 55.0° / 75.0°
 Efficiency 84 %
 Peak intensity 1.1 cd/lm
 LEDs/each optic 1
 Light colour White
 Required components:
 F17435_HEKLA-G2-C

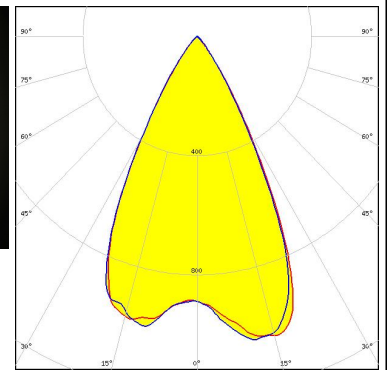
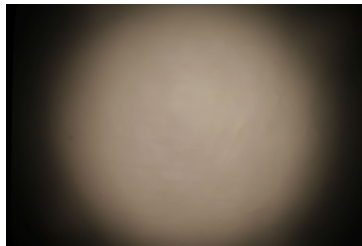

CITIZEN

LED CLU7B2
 FWHM / FWTM 54.0° / 74.0°
 Efficiency 84 %
 Peak intensity 1.1 cd/lm
 LEDs/each optic 1
 Light colour White
 Required components:
 F17435_HEKLA-G2-C

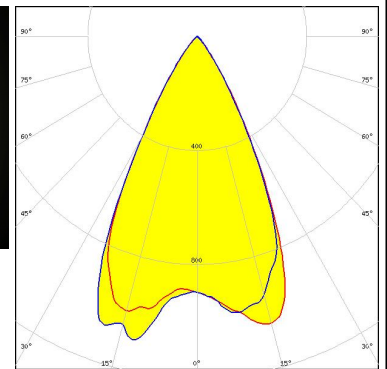

CREE LED

LED CMA1516
 FWHM / FWTM 54.0° / 76.0°
 Efficiency 83 %
 Peak intensity 1 cd/lm
 LEDs/each optic 1
 Light colour White
 Required components:
 F17436_HEKLA-G2-D

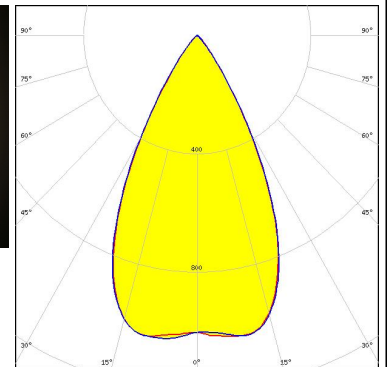
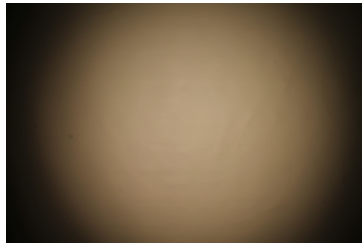

PHOTOMETRIC DATA (MEASURED):

CREE LED

LED CMT14xx
 FWHM / FWTM 54.0° / 76.0°
 Efficiency 83 %
 Peak intensity 1.1 cd/lm
 LEDs/each optic 1
 Light colour White
 Required components:
 F17435_HEKLA-G2-C

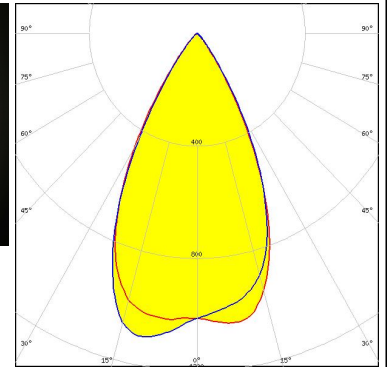

CREE LED

LED CMU10xx
 FWHM / FWTM 48.0° / 72.0°
 Efficiency 81 %
 Peak intensity 1.3 cd/lm
 LEDs/each optic 1
 Light colour White
 Required components:
 F17435_HEKLA-G2-C

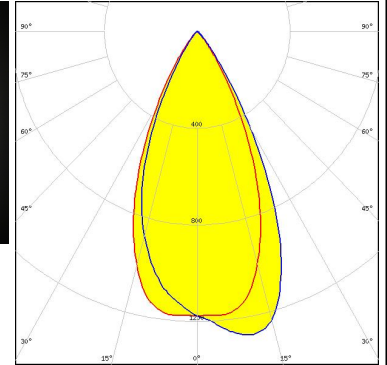
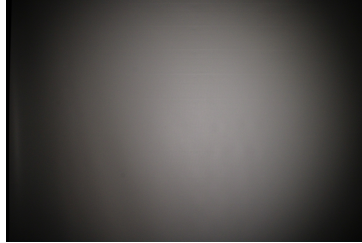

CREE LED

LED CXA/B 13xx
 FWHM / FWTM 55.0° / 74.0°
 Efficiency 84 %
 Peak intensity 1.1 cd/lm
 LEDs/each optic 1
 Light colour White
 Required components:
 F17439_HEKLA-G2-J

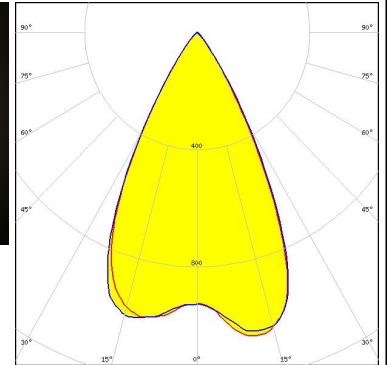



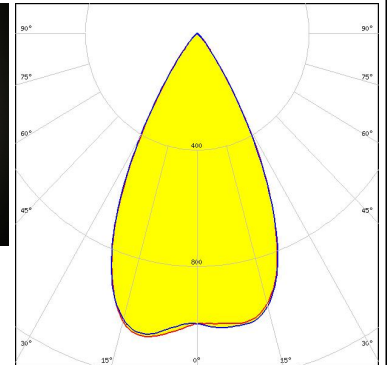

CREE LED

LED CXA/B 15xx
 FWHM / FWTM 54.0° / 75.0°
 Efficiency 84 %
 Peak intensity 1.1 cd/lm
 LEDs/each optic 1
 Light colour White
 Required components:
 F17436_HEKLA-G2-D

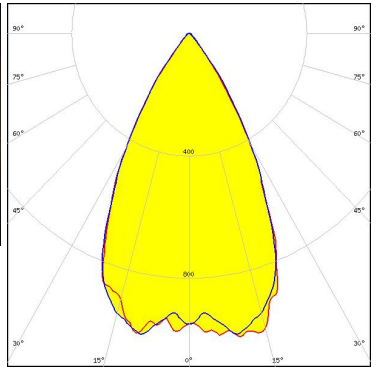

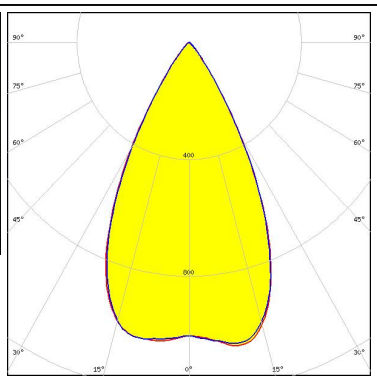
PHOTOMETRIC DATA (MEASURED):

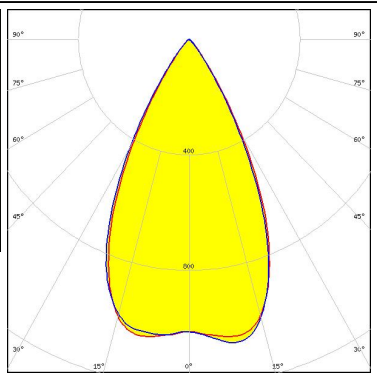
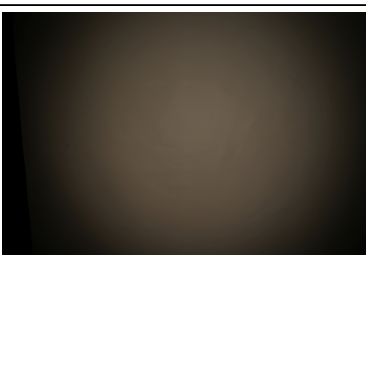
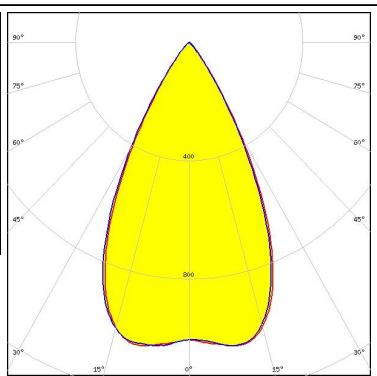
<p>LEDiM</p> <p>LED LEDIM/C6 FWHM / FWTM 57.0° / 78.0° Efficiency 83 % Peak intensity 1 cd/lm LEDs/each optic 9 Light colour White Required components: F17438_HEKLA-G2-I</p>		
<p>LUMILEDS</p> <p>LED LUXEON CoB 1202/1203 FWHM / FWTM 54.0° / 75.0° Efficiency 83 % Peak intensity 1.1 cd/lm LEDs/each optic 1 Light colour White Required components: F17437_HEKLA-G2-H</p>		
<p>LUMILEDS</p> <p>LED LUXEON CoB 1204HD FWHM / FWTM 53.0° / 75.0° Efficiency 83 % Peak intensity 1.1 cd/lm LEDs/each optic 1 Light colour White Required components: F17437_HEKLA-G2-H</p>		
<p>LUMILEDS</p> <p>LED LUXEON CoB M02/M03 FWHM / FWTM 54.0° / 75.0° Efficiency 84 % Peak intensity 1.1 cd/lm LEDs/each optic 1 Light colour White Required components: F17436_HEKLA-G2-D</p>		

PHOTOMETRIC DATA (MEASURED):

LUMILEDS

LED LUXEON CoB S01
 FWHM / FWTM 55.0° / 75.0°
 Efficiency 84 %
 Peak intensity 1.1 cd/lm
 LEDs/each optic 1
 Light colour White
 Required components:
 F17439_HEKLA-G2-J

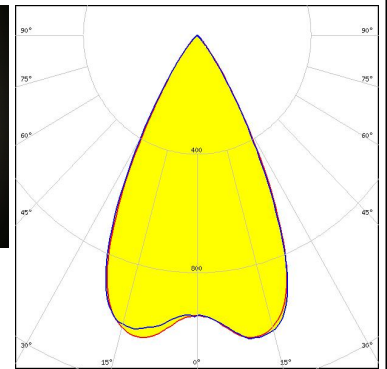

LUMINUS

LED CXM-3
 FWHM / FWTM 55.0° / 75.0°
 Efficiency 84 %
 Peak intensity 1.1 cd/lm
 LEDs/each optic 1
 Light colour White
 Required components:
 F17435_HEKLA-G2-C

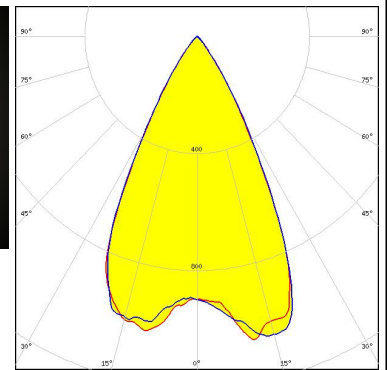
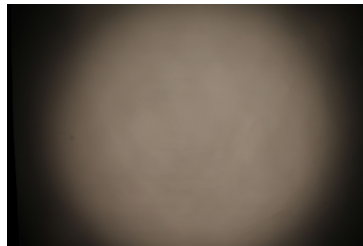

LUMINUS

LED CXM-4
 FWHM / FWTM 55.0° / 75.0°
 Efficiency 84 %
 Peak intensity 1.1 cd/lm
 LEDs/each optic 1
 Light colour White
 Required components:
 F17435_HEKLA-G2-C

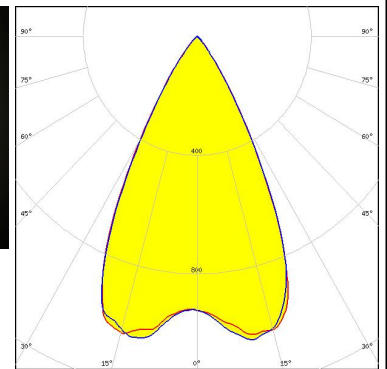

NICHIA

LED COB L-Type (LES 9)
 FWHM / FWTM 54.0° / 76.0°
 Efficiency 83 %
 Peak intensity 1 cd/lm
 LEDs/each optic 1
 Light colour White
 Required components:
 F17437_HEKLA-G2-H

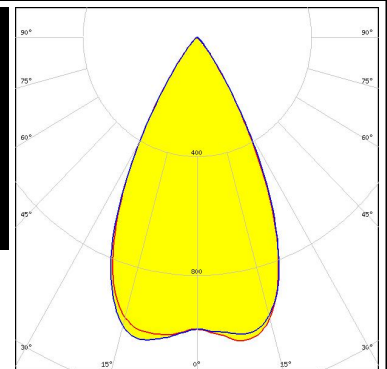
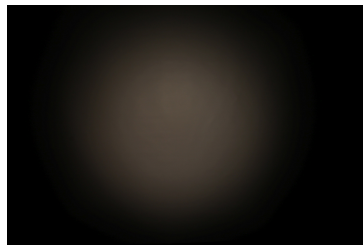

PHOTOMETRIC DATA (MEASURED):



LED COB S-Type (LES 7)
 FWHM / FWTM 55.0° / 75.0°
 Efficiency 82 %
 Peak intensity 1 cd/lm
 LEDs/each optic 1
 Light colour White
 Required components:
 F15848_HEKLA-SOCKET-G

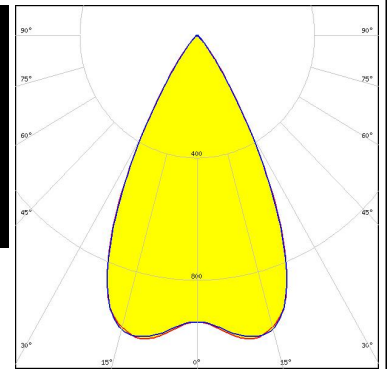
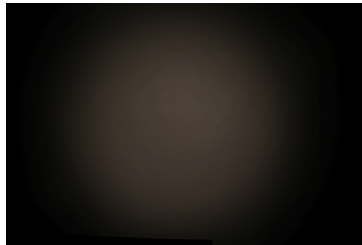

LED Fortimo SLM L09 CoB
 FWHM / FWTM 54.0° / 75.0°
 Efficiency 83 %
 Peak intensity 1.1 cd/lm
 LEDs/each optic 1
 Light colour White
 Required components:
 F17437_HEKLA-G2-H

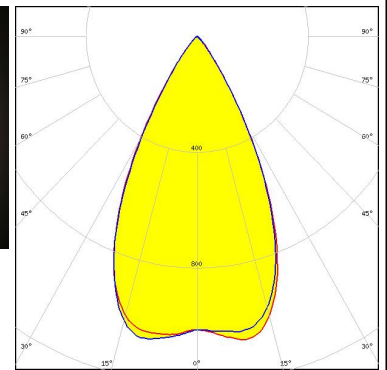
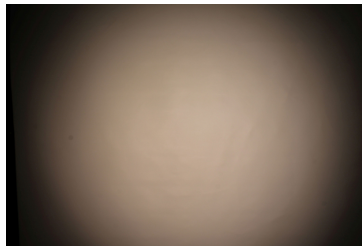



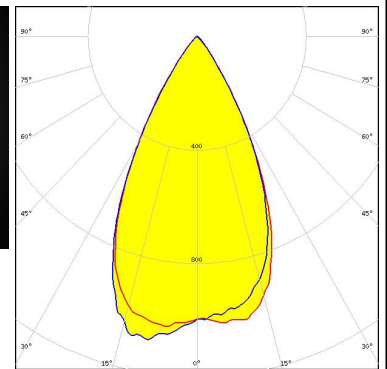
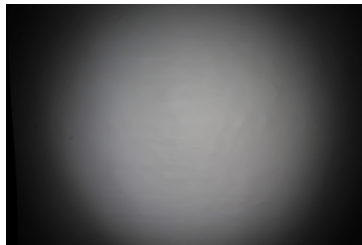

LED LC003D / LC006D / LC009D / LC013D
 FWHM / FWTM 54.0° / 76.0°
 Efficiency 83 %
 Peak intensity 1.1 cd/lm
 LEDs/each optic 1
 Light colour White
 Required components:
 F17435_HEKLA-G2-C

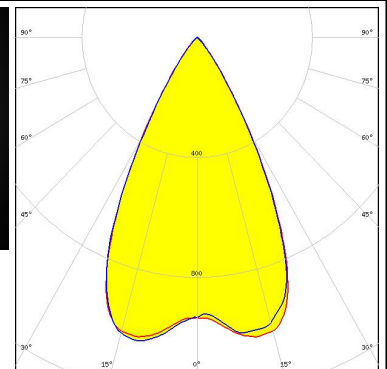
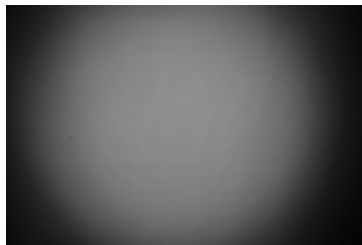

SEOL SEMICONDUCTOR
 LED MJT COB LES 6
 FWHM / FWTM 55.0° / 75.0°
 Efficiency 84 %
 Peak intensity 1.1 cd/lm
 LEDs/each optic 1
 Light colour White
 Required components:
 F17435_HEKLA-G2-C

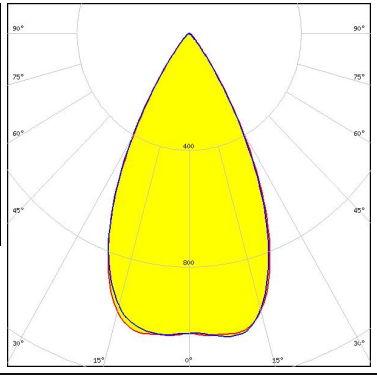

PHOTOMETRIC DATA (MEASURED):

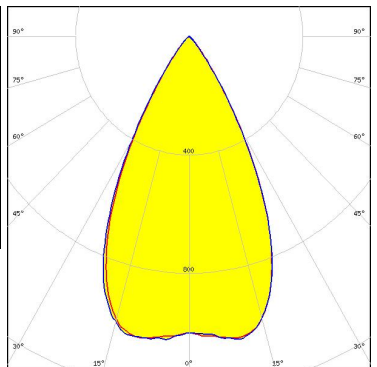
<p> SEUL SEMICONDUCTOR</p> <p>LED MJT COB LES 9.8</p> <p>FWHM / FWTM 54.0° / 76.0°</p> <p>Efficiency 83 %</p> <p>Peak intensity 1 cd/lm</p> <p>LEDs/each optic 1</p> <p>Light colour White</p> <p>Required components: F17435_HEKLA-G2-C</p>		
<p>TRIDONIC</p> <p>LED SLE G7 LES09</p> <p>FWHM / FWTM 54.0° / 76.0°</p> <p>Efficiency 84 %</p> <p>Peak intensity 1 cd/lm</p> <p>LEDs/each optic 1</p> <p>Light colour White</p> <p>Required components: F17435_HEKLA-G2-C</p>		

PHOTOMETRIC DATA (SIMULATED):



LED Vero SE 13
FWHM / FWTM 44.0° / 69.0°
Efficiency 77 %
Peak intensity 1.4 cd/lm
LEDs/each optic 1
Light colour White
Required components:
 C16142_HEKLA-SOCKET-K

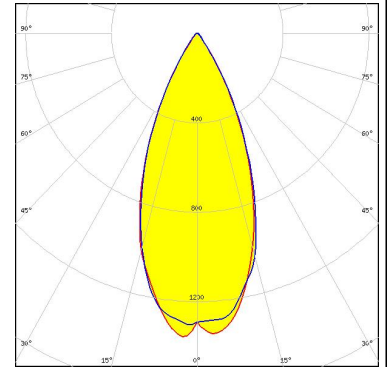

LED NVCWJ024Z-V1MT: COB J-Type Tunable White
FWHM / FWTM 63.0° / 84.0°
Efficiency 81 %
Peak intensity 0.8 cd/lm
LEDs/each optic 1
Light colour White
Required components:
 C16142_HEKLA-SOCKET-K
 Bender Wirth: 498 Typ L8 HV

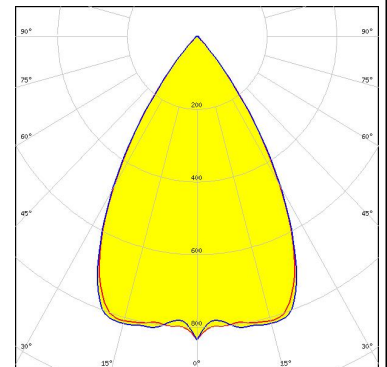

LED SLE G7 LES13
FWHM / FWTM 56.0° / 80.0°
Efficiency 81 %
Peak intensity 1 cd/lm
LEDs/each optic 1
Light colour White
Required components:
 F17438_HEKLA-G2-I

