

YASMEEN-70-S-C

~15° spot beam. Assembly with holder C compatible with HEKLA sockets and connectors. Black version.

TECHNICAL SPECIFICATIONS:

Dimensions	Ø 69.9 mm
Height	39.9 mm
ROHS compliant	yes ⓘ



MATERIAL SPECIFICATIONS:

Component	Type	Material	Colour	Finish
YASMEEN-70-S	Single lens	PMMA	clear	
YASMEEN-70-HLD-C	Holder	PC	black	





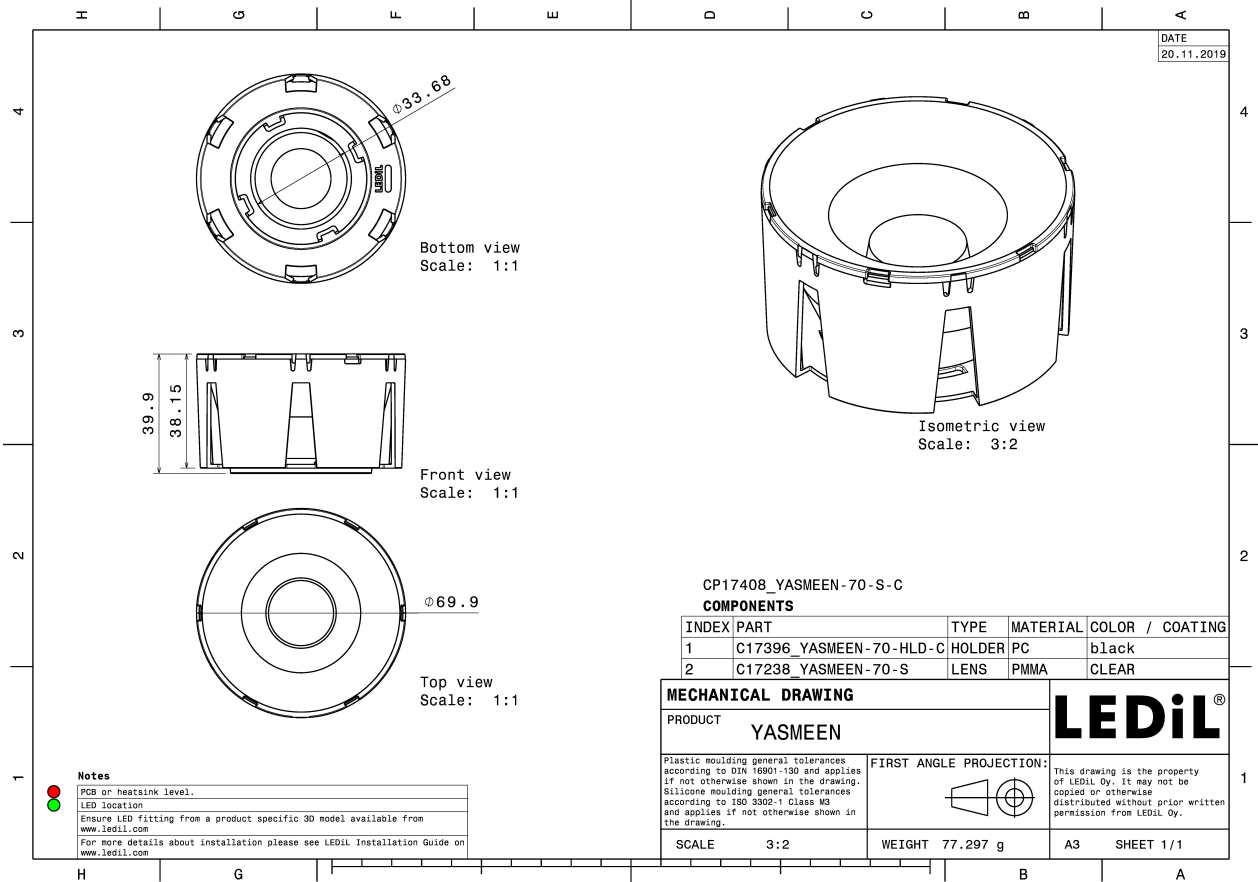



ORDERING INFORMATION:

Component		Qty in box	MOQ	MPQ	Box weight (kg)
CP17408_YASMEEN-70-S-C	Single lens	105	105	15	9.8
» Box size: 476 x 273 x 305 mm					

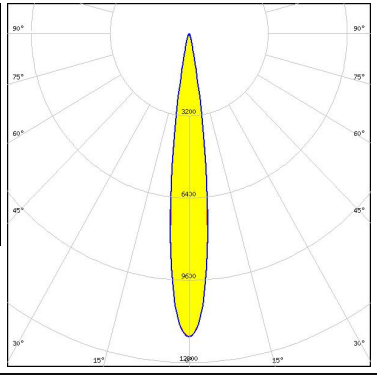

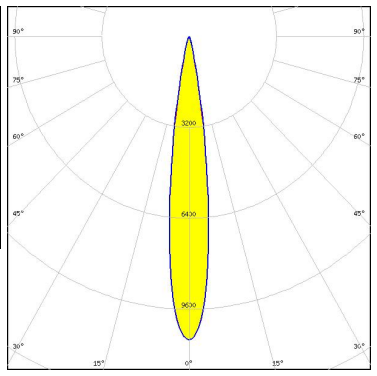

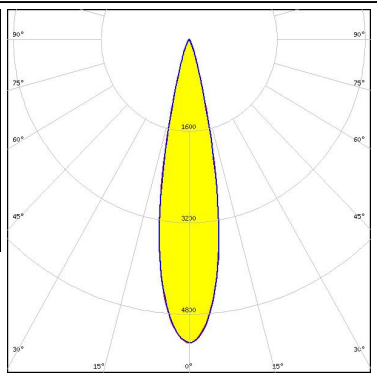

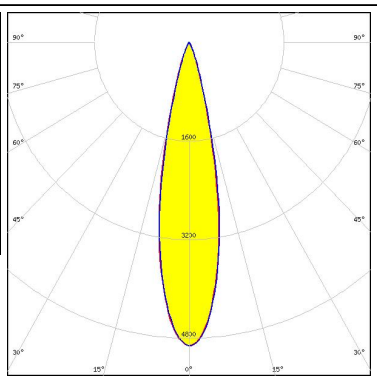
See also our general installation guide: www.ledil.com/installation_guide



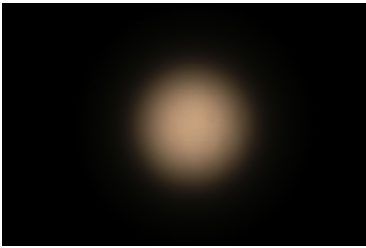
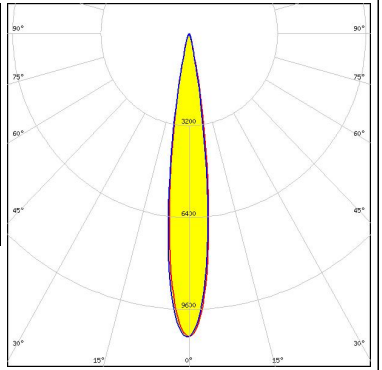
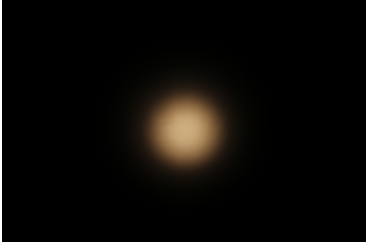
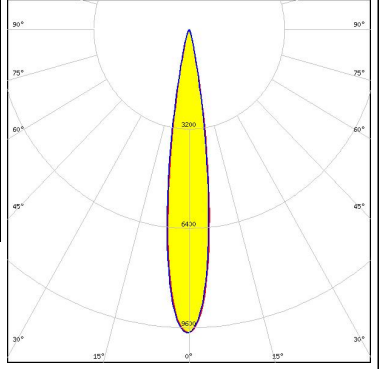

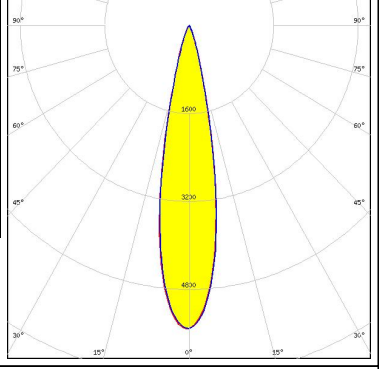
PHOTOMETRIC DATA (MEASURED):

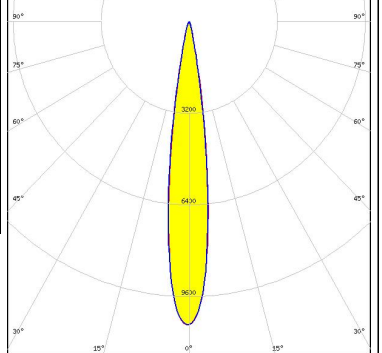
<p></p> <p>LED V9 HD</p> <p>FWHM / FWTM 14.0° / 24.0°</p> <p>Efficiency 87 %</p> <p>Peak intensity 11.8 cd/lm</p> <p>LEDs/each optic 1</p> <p>Light colour White</p> <p>Required components: F15859_HEKLA-SOCKET-I</p>		
<p></p> <p>LED VERO10</p> <p>FWHM / FWTM 14.0° / 25.0°</p> <p>Efficiency 88 %</p> <p>Peak intensity 10.7 cd/lm</p> <p>LEDs/each optic 1</p> <p>Light colour White</p> <p>Required components: F15616_HEKLA-SOCKET-F</p>		
<p></p> <p>LED Vesta DTW 13mm (21W)</p> <p>FWHM / FWTM 22.0° / 37.0°</p> <p>Efficiency 86 %</p> <p>Peak intensity 5.3 cd/lm</p> <p>LEDs/each optic 1</p> <p>Light colour Tunable White</p> <p>Required components: Bender Wirth: 632b Hekla XL</p>		
<p></p> <p>LED Vesta DTW 15mm (33W)</p> <p>FWHM / FWTM 23.0° / 39.0°</p> <p>Efficiency 86 %</p> <p>Peak intensity 4.9 cd/lm</p> <p>LEDs/each optic 1</p> <p>Light colour Tunable White</p> <p>Required components: Bender Wirth: 632b Hekla XL</p>		

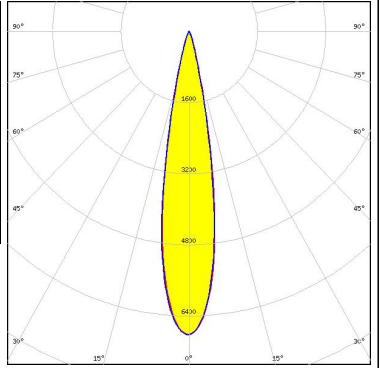
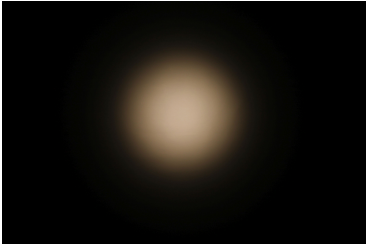
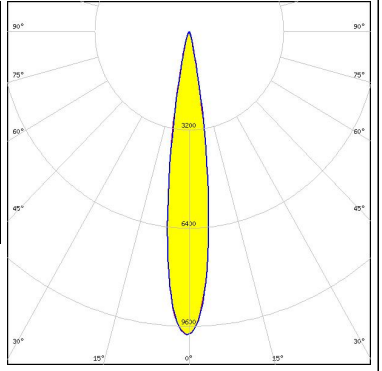

PHOTOMETRIC DATA (MEASURED):

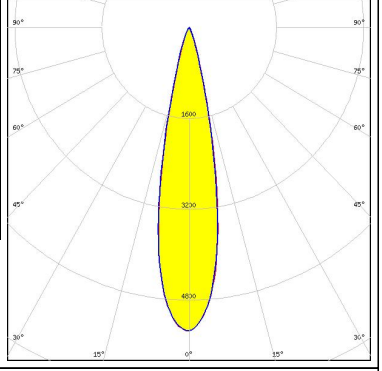
<p></p> <p>LED Vesta DTW 9mm (4W/6W/12W) FWHM / FWTM 15.0° / 26.0° Efficiency 88 % Peak intensity 10.6 cd/lm LEDs/each optic 1 Light colour Tunable White Required components: Bender Wirth: 652b Hekla</p>		
<p>CITIZEN</p> <p>LED CLL02x/CLU02x (LES10) FWHM / FWTM 15.0° / 27.0° Efficiency 87 % Peak intensity 9.8 cd/lm LEDs/each optic 1 Light colour White Required components: F17435_HEKLA-G2-C</p>		
<p>CITIZEN</p> <p>LED CLL03x/CLU03x FWHM / FWTM 21.0° / 36.5° Efficiency 85 % Peak intensity 5.5 cd/lm LEDs/each optic 1 Light colour White Required components: F17438_HEKLA-G2-I</p>		
<p></p> <p>LED CMA1516 FWHM / FWTM 14.0° / 25.0° Efficiency 87 % Peak intensity 10.6 cd/lm LEDs/each optic 1 Light colour White Required components: F17436_HEKLA-G2-D</p>		

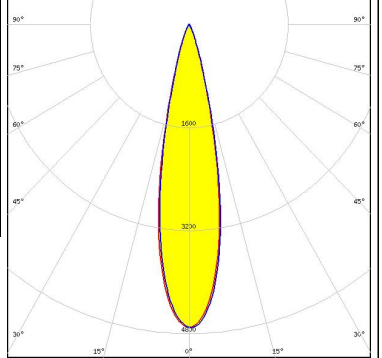
PHOTOMETRIC DATA (MEASURED):

<p>CREE → LED</p> <p>LED CMA1825 FWHM / FWTM 19.0° / 32.0° Efficiency 87 % Peak intensity 6.8 cd/m LEDs/each optic 1 Light colour White Required components: F15254_HEKLA-SOCKET-B</p>		
<p>CREE → LED</p> <p>LED CMT14xx FWHM / FWTM 15.0° / 26.0° Efficiency 86 % Peak intensity 9.9 cd/m LEDs/each optic 1 Light colour White Required components: F17435_HEKLA-G2-C</p>		
<p>CREE → LED</p> <p>LED CMT19xx FWHM / FWTM 21.0° / 36.0° Efficiency 85 % Peak intensity 5.3 cd/m LEDs/each optic 1 Light colour White Required components: F17438_HEKLA-G2-I</p>		
<p>CREE → LED</p> <p>LED CMU15xx FWHM / FWTM 23.0° / 39.0° Efficiency 84 % Peak intensity 4.7 cd/m LEDs/each optic 1 Light colour White Required components: F17438_HEKLA-G2-I</p>		

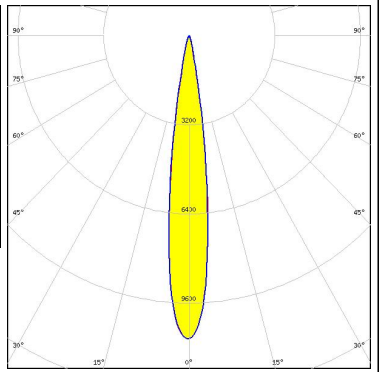
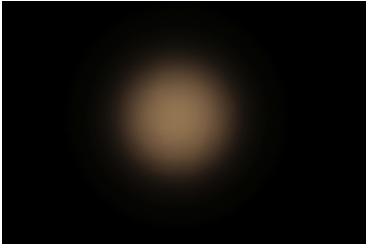
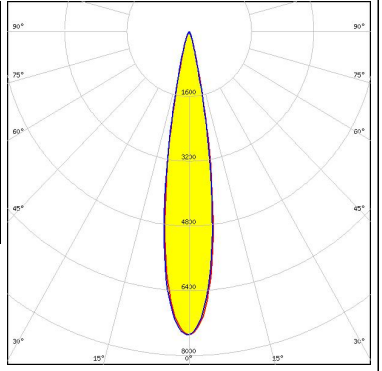
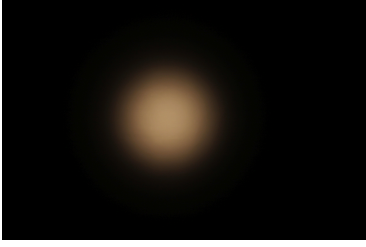
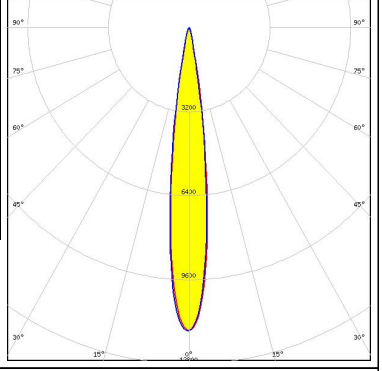
PHOTOMETRIC DATA (MEASURED):

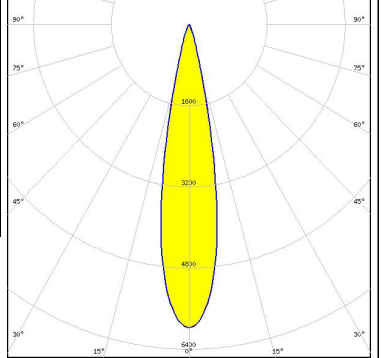
<p>LUMILEDS</p> <p>LED LUXEON CoB 1202/1203</p> <p>FWHM / FWTM 14.0° / 24.0°</p> <p>Efficiency 86 %</p> <p>Peak intensity 10.9 cd/lm</p> <p>LEDs/each optic 1</p> <p>Light colour White</p> <p>Required components: F17437_HEKLA-G2-H</p>		
<p>NICHIA</p> <p>LED COB L-Type (LES 11)</p> <p>FWHM / FWTM 17.0° / 30.0°</p> <p>Efficiency 86 %</p> <p>Peak intensity 7.5 cd/lm</p> <p>LEDs/each optic 1</p> <p>Light colour White</p> <p>Required components: F17437_HEKLA-G2-H</p>		
<p>NICHIA</p> <p>LED COB L-Type (LES 9)</p> <p>FWHM / FWTM 13.0° / 24.0°</p> <p>Efficiency 86 %</p> <p>Peak intensity 11.5 cd/lm</p> <p>LEDs/each optic 1</p> <p>Light colour White</p> <p>Required components: F17437_HEKLA-G2-H</p>		
<p>NICHIA</p> <p>LED COB S-Type (LES 7)</p> <p>FWHM / FWTM 20.0° / 34.0°</p> <p>Efficiency 85 %</p> <p>Peak intensity 6 cd/lm</p> <p>LEDs/each optic 1</p> <p>Light colour White</p> <p>Required components: F17438_HEKLA-G2-I</p>		

PHOTOMETRIC DATA (MEASURED):

PHILIPS

LED Fortimo SLM L09 CoB
 FWHM / FWTM 14.0° / 25.0°
 Efficiency 86 %
 Peak intensity 10.8 cd/lm
 LEDs/each optic 1
 Light colour White
 Required components:
 F17437_HEKLA-G2-H

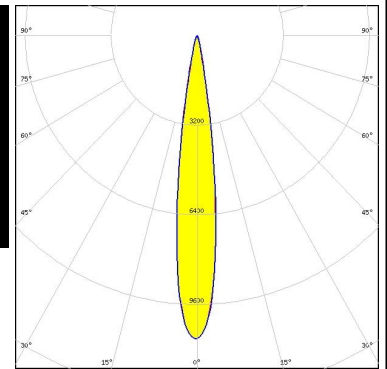

SAMSUNG

LED LC016D / LC019D / LC026D / LC033D
 FWHM / FWTM 23.0° / 39.0°
 Efficiency 85 %
 Peak intensity 4.7 cd/lm
 LEDs/each optic 1
 Light colour White
 Required components:
 F17438_HEKLA-G2-I

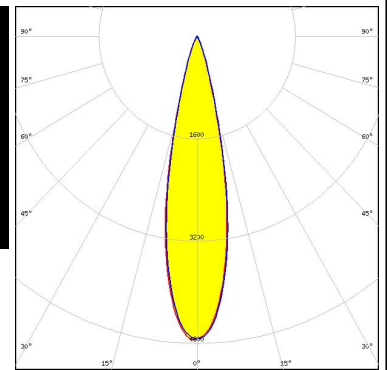
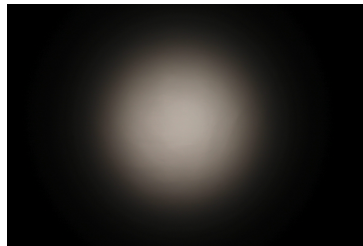

SAMSUNG

LED LC030C/040C G2
 FWHM / FWTM 17.0° / 30.0°
 Efficiency 86 %
 Peak intensity 7.6 cd/lm
 LEDs/each optic 1
 Light colour White
 Required components:
 F17438_HEKLA-G2-I

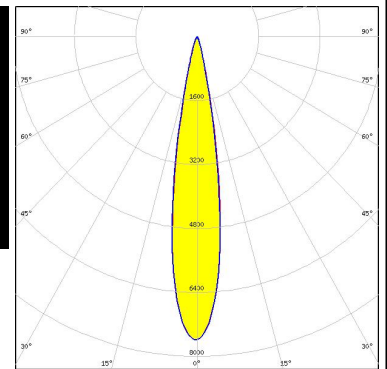

SEOUL SEMICONDUCTOR

LED MJT COB LES 14.5
 FWHM / FWTM 23.0° / 38.0°
 Efficiency 85 %
 Peak intensity 4.8 cd/lm
 LEDs/each optic 1
 Light colour White
 Required components:
 F17438_HEKLA-G2-I

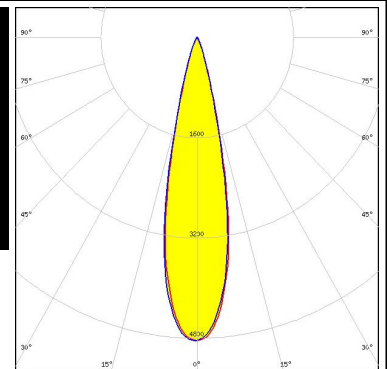
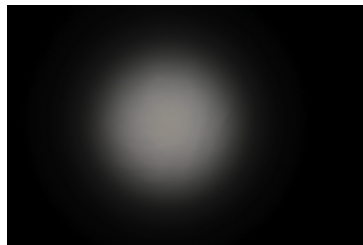

PHOTOMETRIC DATA (MEASURED):

TRIDONIC

LED SLE G7 LES09
 FWHM / FWTM 14.0° / 25.0°
 Efficiency 87 %
 Peak intensity 11.1 cd/lm
 LEDs/each optic 1
 Light colour White
 Required components:
 F17435_HEKLA-G2-C

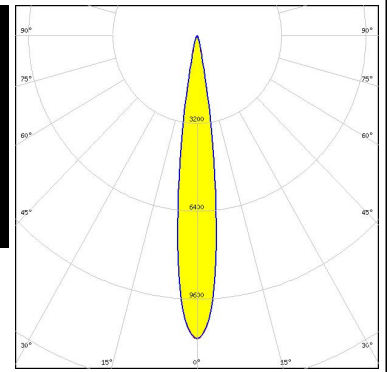
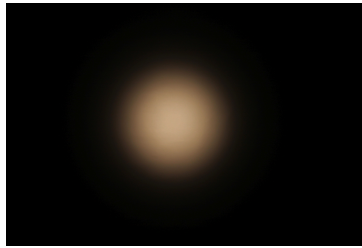



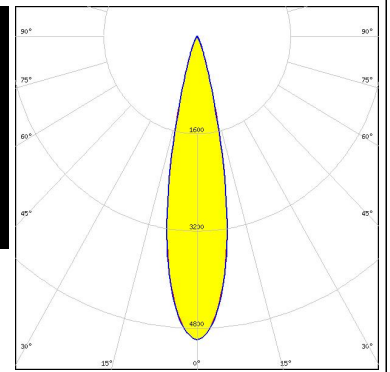

TRIDONIC

LED SLE G7 LES15
 FWHM / FWTM 22.0° / 38.0°
 Efficiency 85 %
 Peak intensity 5 cd/lm
 LEDs/each optic 1
 Light colour White
 Required components:
 F17438_HEKLA-G2-I

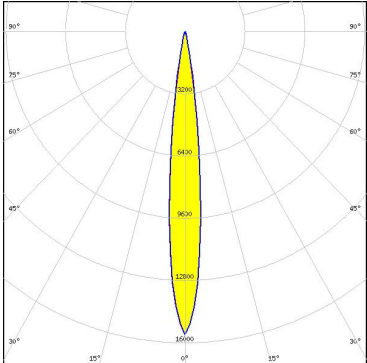

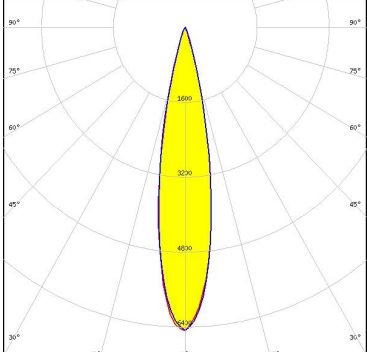
PHOTOMETRIC DATA (SIMULATED):

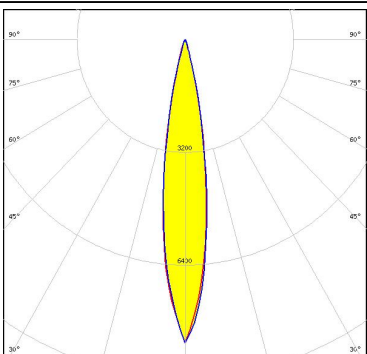
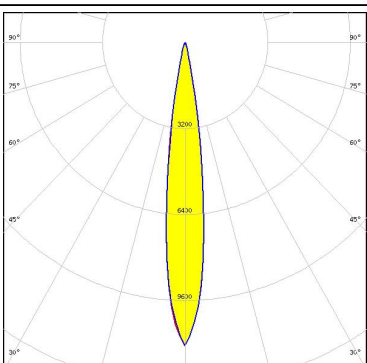
<p></p> <p>LED V6 HD FWHM / FWTM 12.0° / 22.0° Efficiency 89 % Peak intensity 15.6 cd/lm LEDs/each optic 1 Light colour White Required components: F15255_HEKLA-SOCKET-C</p>	
<p></p> <p>LED Vesta TW 13mm (25W) CSP FWHM / FWTM 20.0° / 34.0° Efficiency 90 % Peak intensity 6.5 cd/lm LEDs/each optic 1 Light colour Tunable White Required components: C16142_HEKLA-SOCKET-K</p>	
<p></p> <p>LED Vesta TW 9mm (12W) CSP FWHM / FWTM 16.0° / 30.0° Efficiency 90 % Peak intensity 8.6 cd/lm LEDs/each optic 1 Light colour Tunable White Required components: C16142_HEKLA-SOCKET-K</p>	
<p>CITIZEN</p> <p>LED CLU712 FWHM / FWTM 14.0° / 26.0° Efficiency 87 % Peak intensity 11.3 cd/lm LEDs/each optic 1 Light colour White Required components: F17438_HEKLA-G2-I</p>	

PHOTOMETRIC DATA (SIMULATED):

<p>CREE LED</p> <p>LED: CMA1306 FWHM / FWTM: 12.0° / 22.0° Efficiency: 88 % Peak intensity: 16.1 cd/lm LEDs/each optic: 1 Light colour: White Required components: F17435_HEKLA-G2-C</p>	
<p>CREE LED</p> <p>LED: CMU10xx FWHM / FWTM: 16.0° / 28.0° Efficiency: 88 % Peak intensity: 9.9 cd/lm LEDs/each optic: 1 Light colour: White Required components: F17435_HEKLA-G2-C</p>	
<p>CREE LED</p> <p>LED: CXA/B 13xx FWHM / FWTM: 12.0° / 22.0° Efficiency: 88 % Peak intensity: 14.9 cd/lm LEDs/each optic: 1 Light colour: White Required components: F17439_HEKLA-G2-J</p>	
<p>CREE LED</p> <p>LED: CXA/B 15xx FWHM / FWTM: 14.0° / 26.0° Efficiency: 87 % Peak intensity: 11 cd/lm LEDs/each optic: 1 Light colour: White Required components: F17436_HEKLA-G2-D</p>	

PHOTOMETRIC DATA (SIMULATED):

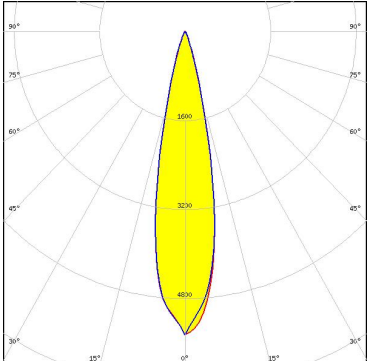
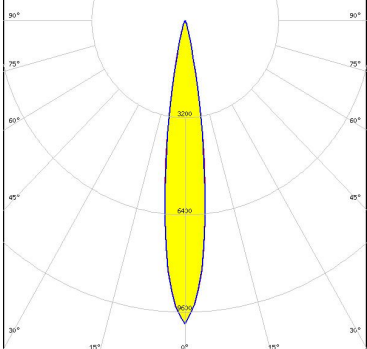
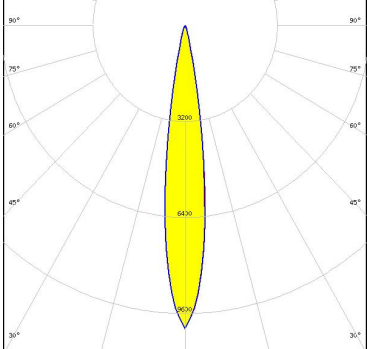
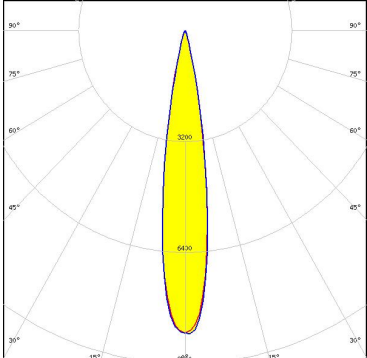
<p>CREE LED</p> <p>LED: CXA/B 1830 FWHM / FWTM: 22.0° / 36.0° Efficiency: 87 % Peak intensity: 5.5 cd/lm LEDs/each optic: 1 Light colour: White Required components: Bender Wirth: 637b Hekla</p>	
<p>PHILIPS</p> <p>LED: Fortimo SLM L09 CoB FWHM / FWTM: 16.0° / 28.0° Efficiency: 88 % Peak intensity: 10 cd/lm LEDs/each optic: 1 Light colour: White Required components: F17435_HEKLA-G2-C</p>	
<p>PHILIPS</p> <p>LED: Fortimo SLM L13 CoB FWHM / FWTM: 16.0° / 28.0° Efficiency: 87 % Peak intensity: 10.1 cd/lm LEDs/each optic: 1 Light colour: White Required components: Bender Wirth: 632a Hekla XL</p>	
<p>SAMSUNG</p> <p>LED: LC003D / LC006D / LC009D / LC013D FWHM / FWTM: 16.0° / 28.0° Efficiency: 87 % Peak intensity: 8.8 cd/lm LEDs/each optic: 1 Light colour: White Required components: F17435_HEKLA-G2-C</p>	

PHOTOMETRIC DATA (SIMULATED):

TRIDONIC

LED	SLE G7 LES13
FWHM / FWTM	20.0° / 34.0°
Efficiency	87 %
Peak intensity	6.1 cd/lm
LEDs/each optic	1
Light colour	White
Required components:	
	F17438_HEKLA-G2-I

