

YASMEEN-50-M-C-WHT

~26° spot beam. Assembly with holder C compatible with HEKLA sockets and connectors. White version.

TECHNICAL SPECIFICATIONS:

Dimensions	49.9 x 49.9 mm
Height	28.1 mm
ROHS compliant	yes ⓘ



MATERIAL SPECIFICATIONS:

Component	Type	Material	Colour	Finish
YASMEEN-50-M	Single lens	PMMA	clear	
YASMEEN-50-HLD-C-WHT	Holder	PC	white	





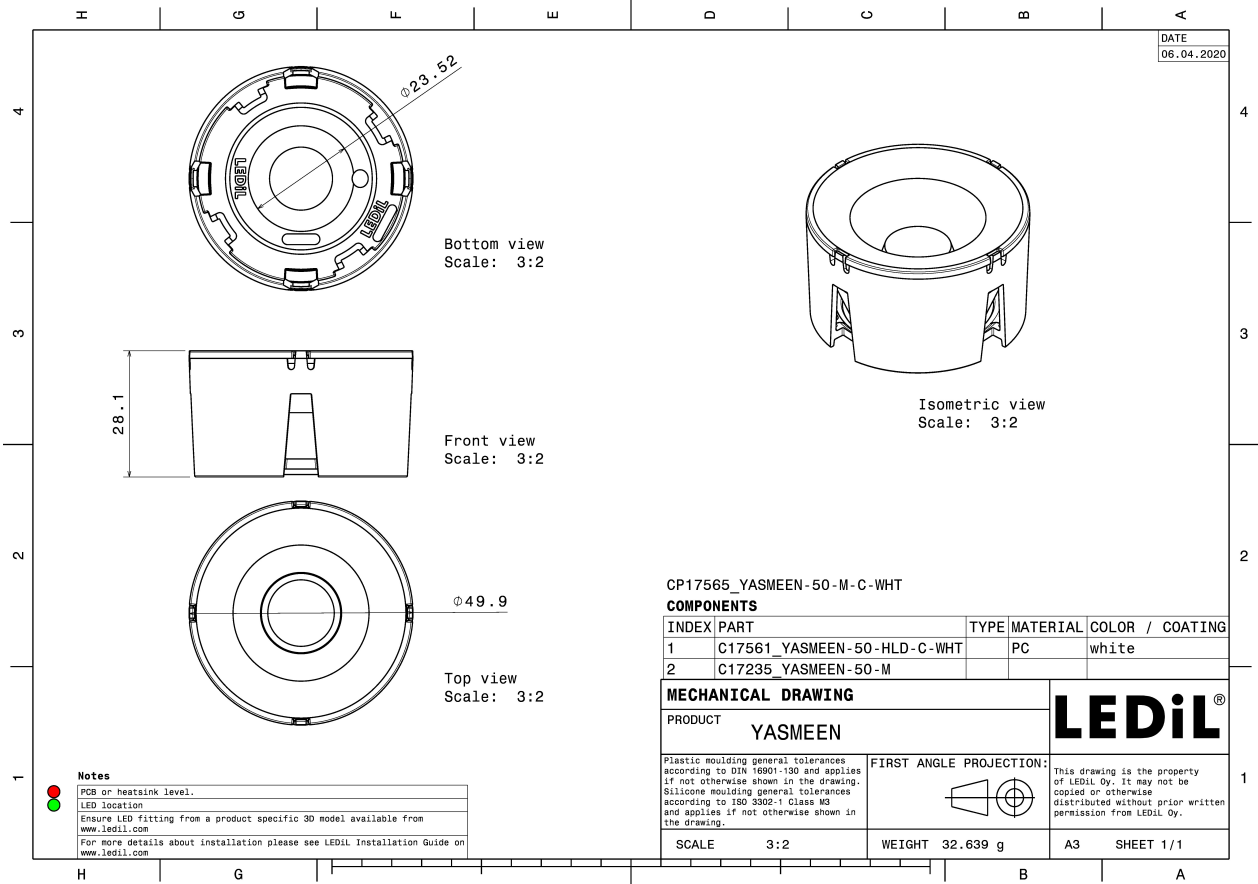

ORDERING INFORMATION:

Component		Qty in box	MOQ	MPQ	Box weight (kg)
CP17565_YASMEEN-50-M-C-WHT	Single lens	252	112	28	9.8
» Box size: 476 x 273 x 305 mm					

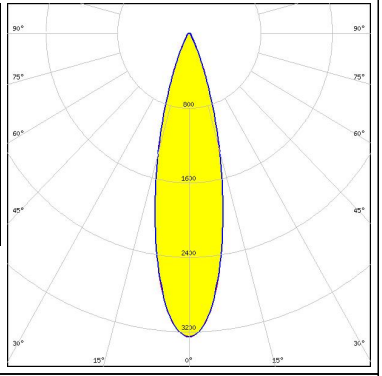

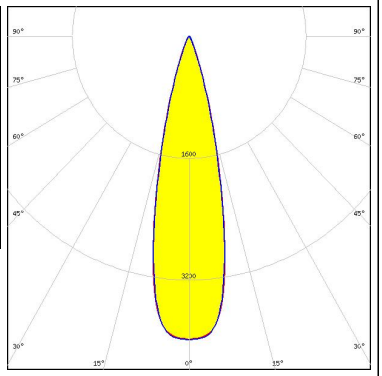

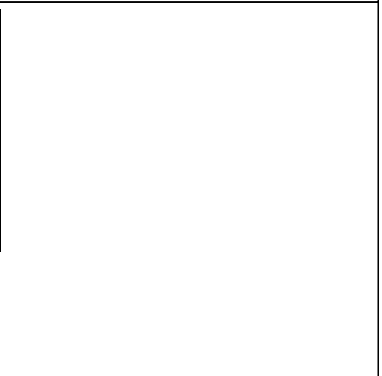

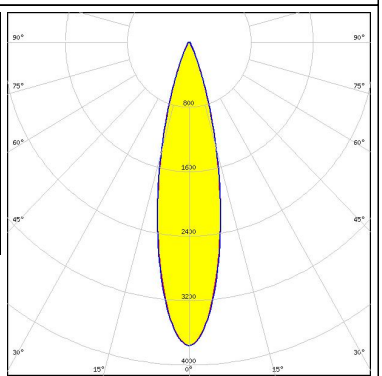

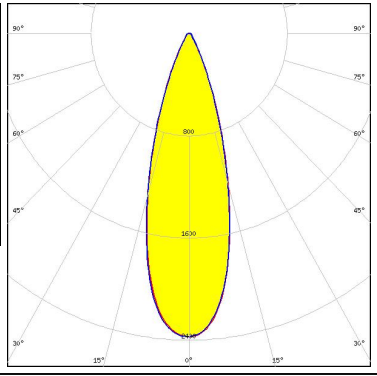

See also our general installation guide: www.ledil.com/installation_guide

PHOTOMETRIC DATA (MEASURED):

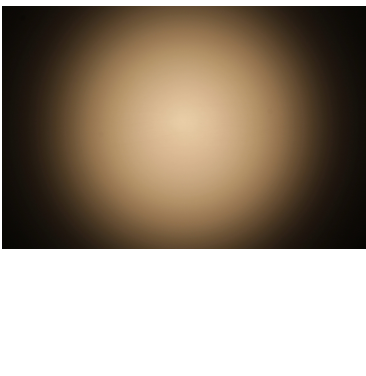
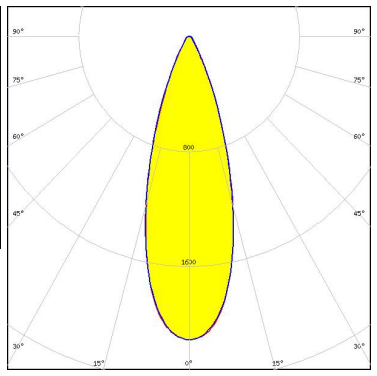
<p>bridgelux.</p> <p>LED V11 HD</p> <p>FWHM / FWTM 27.0° / 50.0°</p> <p>Efficiency 92 %</p> <p>Peak intensity 3.3 cd/lm</p> <p>LEDs/each optic 1</p> <p>Light colour White</p> <p>Required components: Bender Wirth: 633d Hekla</p>		
<p>bridgelux.</p> <p>LED V4 HD</p> <p>FWHM / FWTM 25.0° / 42.0°</p> <p>Efficiency 92 %</p> <p>Peak intensity 4 cd/lm</p> <p>LEDs/each optic 1</p> <p>Light colour White</p> <p>Required components: F15253_HEKLA-SOCKET-A</p>		
<p>bridgelux.</p> <p>LED V6 HD</p> <p>FWHM / FWTM 24.0° / 42.0°</p> <p>Efficiency 92 %</p> <p>Peak intensity 4.1 cd/lm</p> <p>LEDs/each optic 1</p> <p>Light colour White</p> <p>Required components: F15255_HEKLA-SOCKET-C</p>		
<p>bridgelux.</p> <p>LED VERO10</p> <p>FWHM / FWTM 24.0° / 46.0°</p> <p>Efficiency 91 %</p> <p>Peak intensity 3.8 cd/lm</p> <p>LEDs/each optic 1</p> <p>Light colour White</p> <p>Required components: F15616_HEKLA-SOCKET-F</p>		

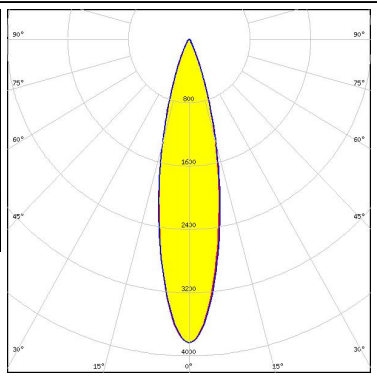
PHOTOMETRIC DATA (MEASURED):

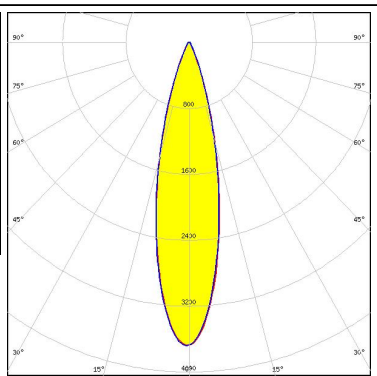
<p></p> <p>LED Vesta DTW 13mm (21W) FWHM / FWTM 32.0° / 56.0° Efficiency 90 % Peak intensity 2.4 cd/m LEDs/each optic 1 Light colour Tunable White Required components: Bender Wirth: 632b Hekla XL</p>		
<p></p> <p>LED Vesta DTW 15mm (33W) FWHM / FWTM 33.0° / 59.0° Efficiency 89 % Peak intensity 2.1 cd/m LEDs/each optic 1 Light colour Tunable White Required components: Bender Wirth: 632b Hekla XL</p>		
<p></p> <p>LED Vesta DTW 9mm (4W/6W/12W) FWHM / FWTM 24.0° / 46.0° Efficiency 92 % Peak intensity 3.8 cd/m LEDs/each optic 1 Light colour White Required components: Bender Wirth: 652b Hekla</p>		
<p>CITIZEN</p> <p>LED CLL02x/CLU02x (LES10) FWHM / FWTM 25.0° / 46.0° Efficiency 91 % Peak intensity 3.7 cd/m LEDs/each optic 1 Light colour White Required components: F17435_HEKLA-G2-C</p>		

PHOTOMETRIC DATA (MEASURED):

CITIZEN

LED CLU700/701/702
 FWHM / FWTM 24.0° / 42.0°
 Efficiency 92 %
 Peak intensity 4.1 cd/lm
 LEDs/each optic 1
 Light colour White
 Required components:
 F17435_HEKLA-G2-C

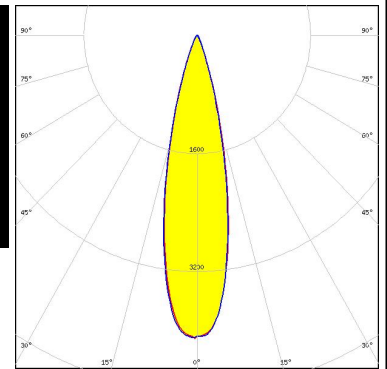

CITIZEN

LED CLU7A2 (LES 4.2mm)
 FWHM / FWTM 25.0° / 41.5°
 Efficiency 92 %
 Peak intensity 4 cd/lm
 LEDs/each optic 1
 Light colour White
 Required components:
 F17435_HEKLA-G2-C

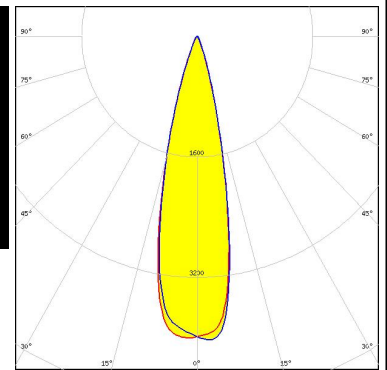
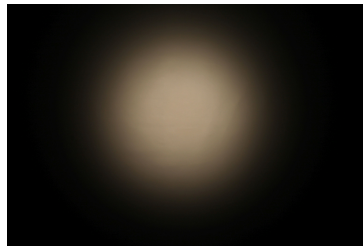

CITIZEN

LED CLU7B2
 FWHM / FWTM 26.0° / 42.0°
 Efficiency 92 %
 Peak intensity 3.8 cd/lm
 LEDs/each optic 1
 Light colour White
 Required components:
 F17435_HEKLA-G2-C

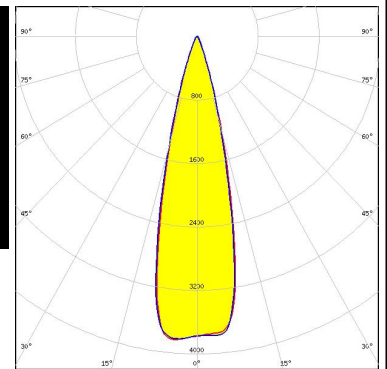
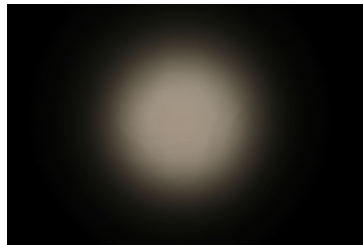

CREE LED

LED CMA1516
 FWHM / FWTM 24.0° / 45.0°
 Efficiency 91 %
 Peak intensity 3.9 cd/lm
 LEDs/each optic 1
 Light colour White
 Required components:
 F17436_HEKLA-G2-D

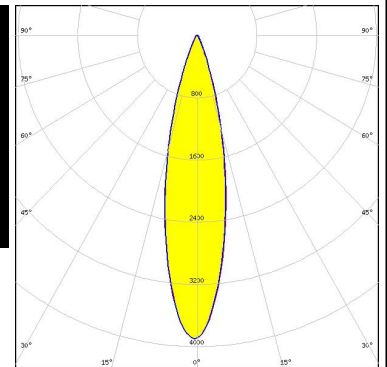

PHOTOMETRIC DATA (MEASURED):

CREE LED

LED CMT14xx
 FWHM / FWTM 24.0° / 46.0°
 Efficiency 91 %
 Peak intensity 3.7 cd/lm
 LEDs/each optic 1
 Light colour White
 Required components:
 F17435_HEKLA-G2-C

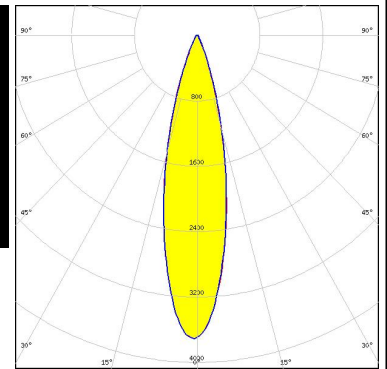
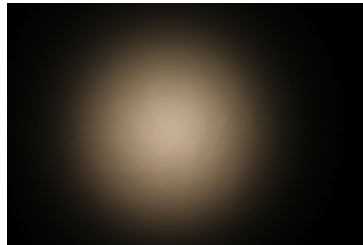

CREE LED

LED CXA/B 13xx
 FWHM / FWTM 25.0° / 43.0°
 Efficiency 93 %
 Peak intensity 4 cd/lm
 LEDs/each optic 1
 Light colour White
 Required components:
 F17439_HEKLA-G2-J

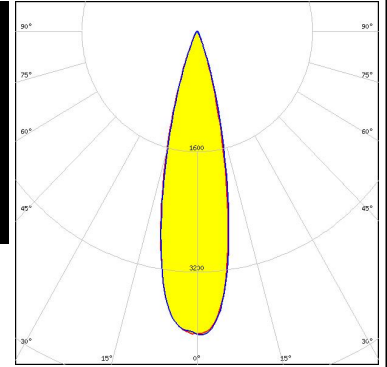

CREE LED

LED CXA/B 15xx
 FWHM / FWTM 24.0° / 45.0°
 Efficiency 92 %
 Peak intensity 3.9 cd/lm
 LEDs/each optic 1
 Light colour White
 Required components:
 F17436_HEKLA-G2-D

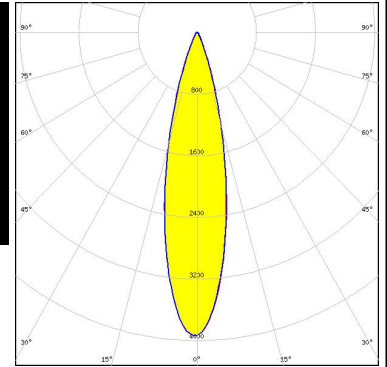

LUMILEDS

LED LUXEON CoB 1202/1203
 FWHM / FWTM 24.0° / 44.0°
 Efficiency 91 %
 Peak intensity 4 cd/lm
 LEDs/each optic 1
 Light colour White
 Required components:
 F17437_HEKLA-G2-H

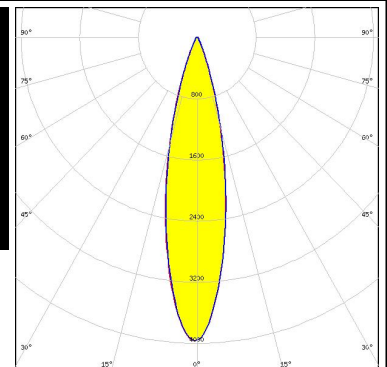
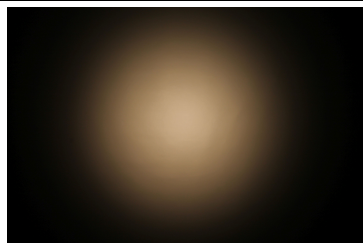

PHOTOMETRIC DATA (MEASURED):

LUMILEDS

LED LUXEON CoB 1204HD
 FWHM / FWTM 23.0° / 45.0°
 Efficiency 91 %
 Peak intensity 4 cd/m
 LEDs/each optic 1
 Light colour White
 Required components:
 F17437_HEKLA-G2-H

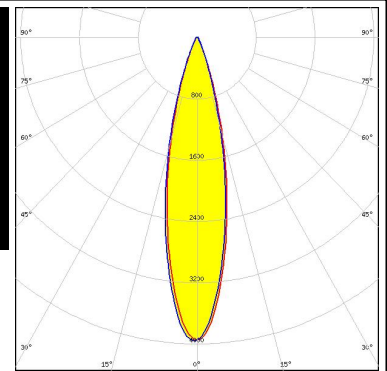
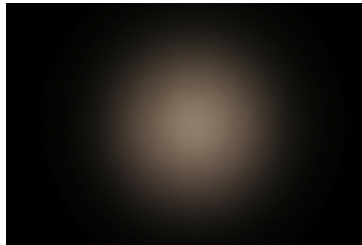

LUMILEDS

LED LUXEON CoB M02/M03
 FWHM / FWTM 24.0° / 45.0°
 Efficiency 92 %
 Peak intensity 3.9 cd/m
 LEDs/each optic 1
 Light colour White
 Required components:
 F17436_HEKLA-G2-D

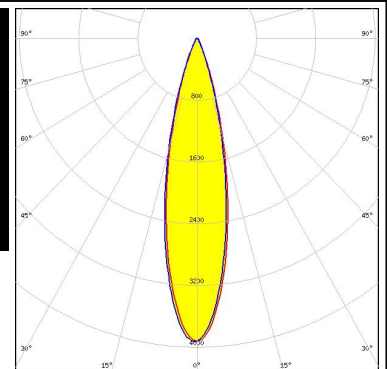
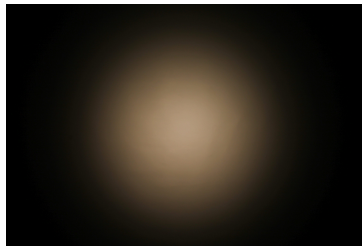

LUMILEDS

LED LUXEON CoB S01
 FWHM / FWTM 24.0° / 42.0°
 Efficiency 92 %
 Peak intensity 4.1 cd/m
 LEDs/each optic 1
 Light colour White
 Required components:
 F17439_HEKLA-G2-J

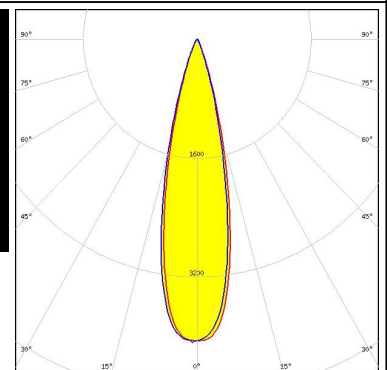
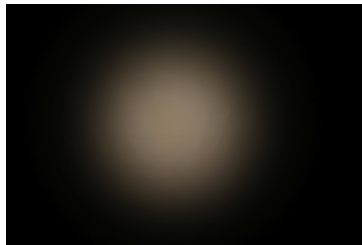

LUMINUS

LED CXM-3
 FWHM / FWTM 25.0° / 41.0°
 Efficiency 92 %
 Peak intensity 3.9 cd/m
 LEDs/each optic 1
 Light colour White
 Required components:
 F17435_HEKLA-G2-C

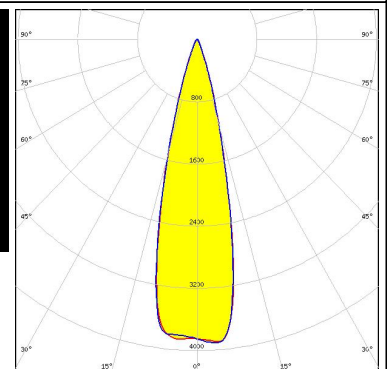

PHOTOMETRIC DATA (MEASURED):



LED CXM-4
 FWHM / FWTM 25.0° / 42.0°
 Efficiency 92 %
 Peak intensity 4 cd/lm
 LEDs/each optic 1
 Light colour White
 Required components:
 F17435_HEKLA-G2-C

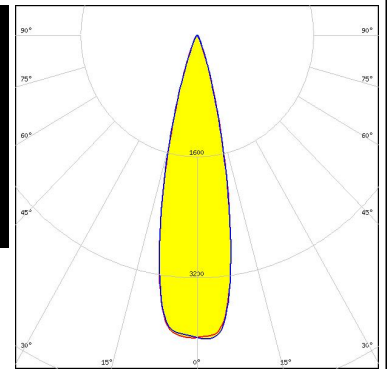

LED COB L-Type (LES 9)
 FWHM / FWTM 24.0° / 44.0°
 Efficiency 91 %
 Peak intensity 3.9 cd/lm
 LEDs/each optic 1
 Light colour White
 Required components:
 F17437_HEKLA-G2-H

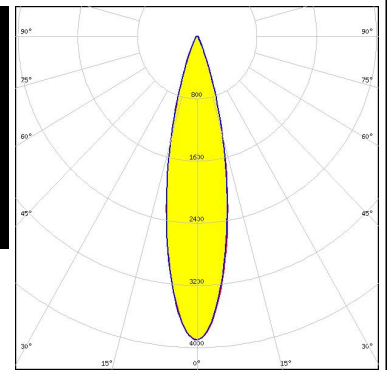
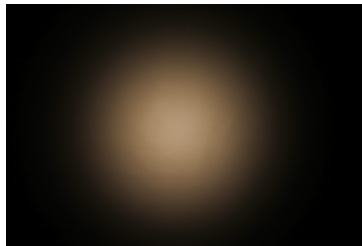

LED COB S-Type (LES 7)
 FWHM / FWTM 25.0° / 44.0°
 Efficiency 91 %
 Peak intensity 4 cd/lm
 LEDs/each optic 1
 Light colour White
 Required components:
 F15848_HEKLA-SOCKET-G

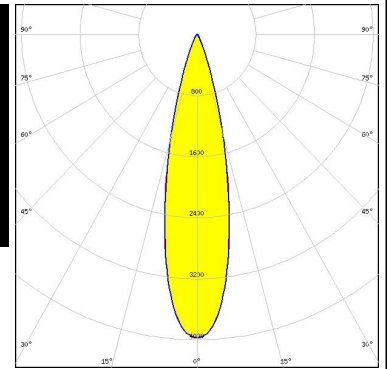

LED Fortimo SLM L09 CoB
 FWHM / FWTM 23.0° / 44.0°
 Efficiency 91 %
 Peak intensity 4 cd/lm
 LEDs/each optic 1
 Light colour White
 Required components:
 F17437_HEKLA-G2-H

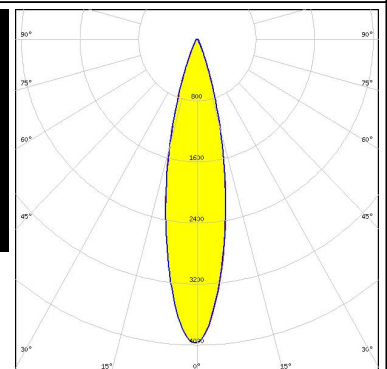
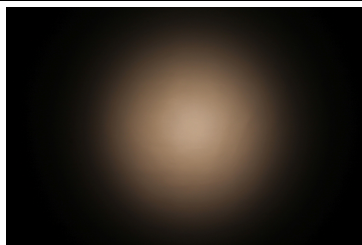

PHOTOMETRIC DATA (MEASURED):

SAMSUNG

LED LC003D / LC006D / LC009D / LC013D
 FWHM / FWTM 24.0° / 46.0°
 Efficiency 91 %
 Peak intensity 3.7 cd/lm
 LEDs/each optic 1
 Light colour White
 Required components:
 F17435_HEKLA-G2-C

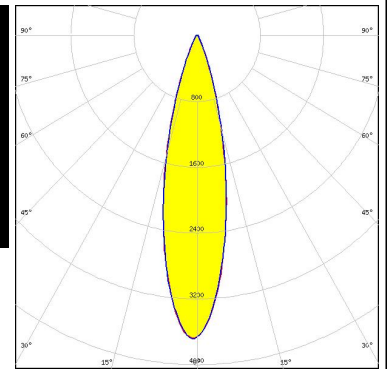

SEOUL SEMICONDUCTOR

LED MJT COB LES 6
 FWHM / FWTM 25.0° / 43.0°
 Efficiency 93 %
 Peak intensity 4 cd/lm
 LEDs/each optic 1
 Light colour White
 Required components:
 F17435_HEKLA-G2-C

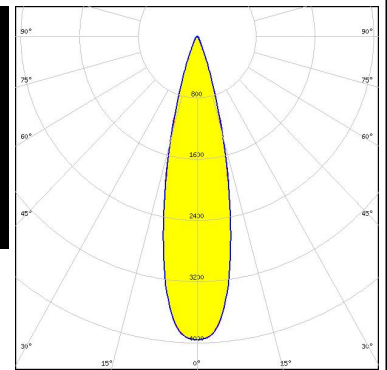

SEOUL SEMICONDUCTOR

LED MJT COB LES 9.8
 FWHM / FWTM 24.0° / 46.0°
 Efficiency 91 %
 Peak intensity 3.7 cd/lm
 LEDs/each optic 1
 Light colour White
 Required components:
 F17435_HEKLA-G2-C

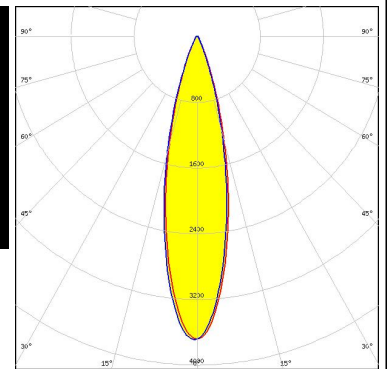
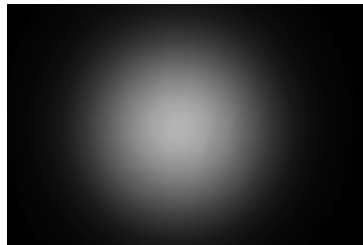

TRIDONIC

LED SLE G7 LES09
 FWHM / FWTM 23.0° / 44.0°
 Efficiency 92 %
 Peak intensity 4 cd/lm
 LEDs/each optic 1
 Light colour White
 Required components:
 F17435_HEKLA-G2-C

