

YASMEEN-50-W-C-WHT

~36° spot beam. Assembly with holder C compatible with HEKLA sockets and connectors. White version.

TECHNICAL SPECIFICATIONS:

| | |
|----------------|-----------|
| Dimensions | Ø 49.9 mm |
| Height | 28.1 mm |
| ROHS compliant | yes ⓘ |



MATERIAL SPECIFICATIONS:

| Component | Type | Material | Colour | Finish |
|----------------------|-------------|----------|--------|--------|
| YASMEEN-50-W | Single lens | PMMA | clear | |
| YASMEEN-50-HLD-C-WHT | Holder | PC | white | |





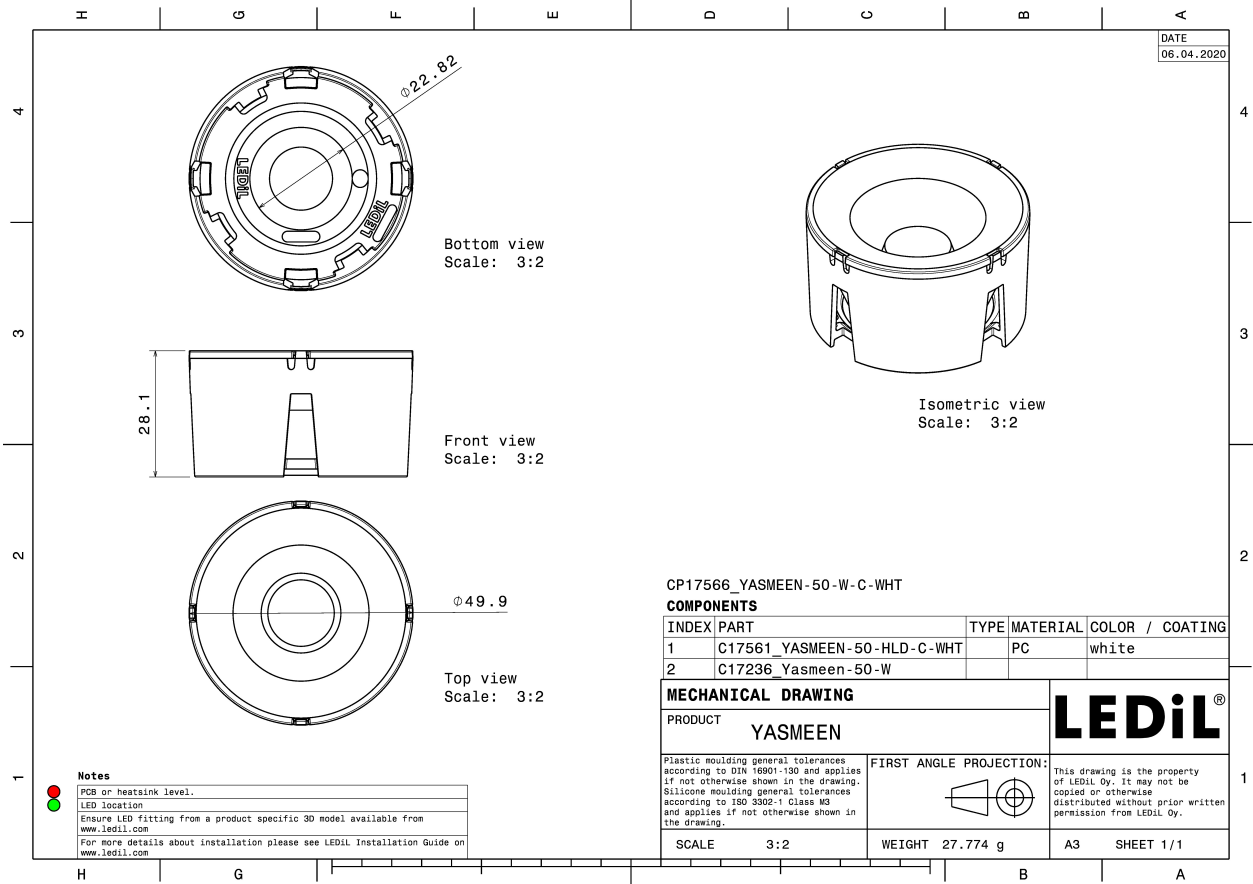



ORDERING INFORMATION:

| Component | Type | Qty in box | MOQ | MPQ | Box weight (kg) |
|--------------------------------|-------------|------------|-----|-----|-----------------|
| CP17566_YASMEEN-50-W-C-WHT | Single lens | 252 | 112 | 28 | 9.2 |
| » Box size: 476 x 273 x 305 mm | | | | | |

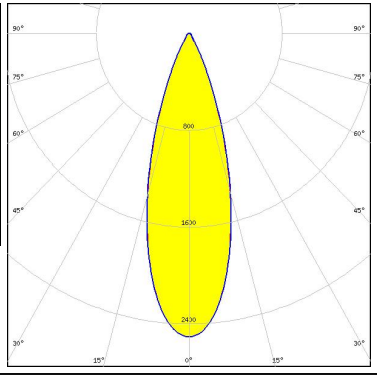

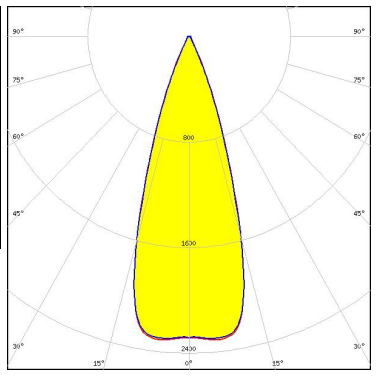

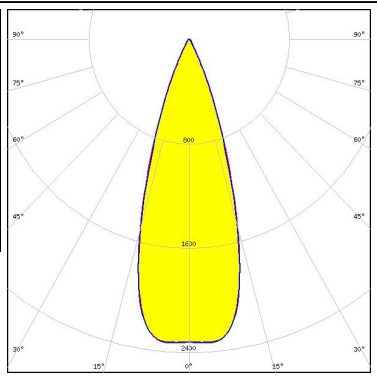

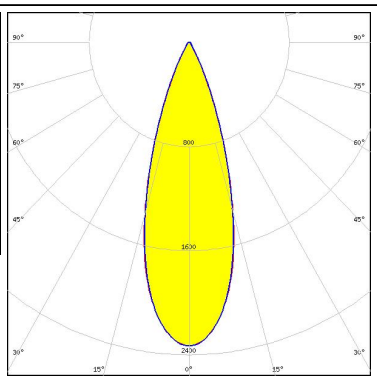

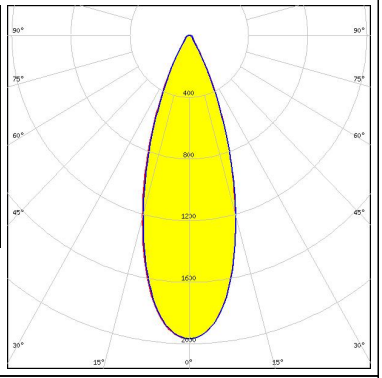

See also our general installation guide: www.ledil.com/installation_guide

PHOTOMETRIC DATA (MEASURED):

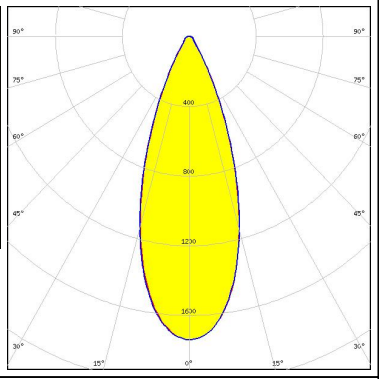
| | | |
|---|--|---|
| <p></p> <p>LED V11 HD FWHM / FWTM 32.0° / 56.0° Efficiency 93 % Peak intensity 2.5 cd/m LEDs/each optic 1 Light colour White Required components: Bender Wirth: 633d Hekla</p> |  |  |
| <p></p> <p>LED V4 HD FWHM / FWTM 34.0° / 52.0° Efficiency 88 % Peak intensity 2.4 cd/m LEDs/each optic 1 Light colour White Required components: F15253_HEKLA-SOCKET-A</p> |  |  |
| <p></p> <p>LED V6 HD FWHM / FWTM 34.0° / 53.0° Efficiency 87 % Peak intensity 2.4 cd/m LEDs/each optic 1 Light colour White Required components: F15255_HEKLA-SOCKET-C</p> |  |  |
| <p></p> <p>LED VERO10 FWHM / FWTM 33.0° / 56.0° Efficiency 86 % Peak intensity 2.3 cd/m LEDs/each optic 1 Light colour White Required components: F15616_HEKLA-SOCKET-F</p> |  |  |

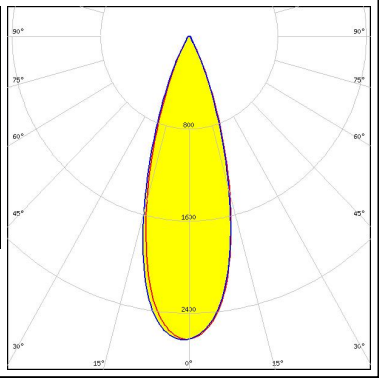
PHOTOMETRIC DATA (MEASURED):

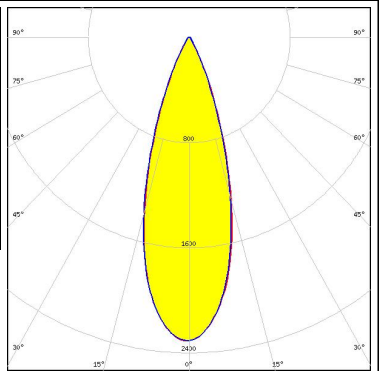
| | | |
|---|--|---|
| <p></p> <p>LED Vesta DTW 13mm (21W) FWHM / FWTM 36.0° / 62.0° Efficiency 90 % Peak intensity 2 cd/lm LEDs/each optic 1 Light colour Tunable White Required components: Bender Wirth: 632b Hekla XL</p> |  |  |
| <p></p> <p>LED Vesta DTW 15mm (33W) FWHM / FWTM 38.0° / 65.0° Efficiency 89 % Peak intensity 1.7 cd/lm LEDs/each optic 1 Light colour Tunable White Required components: Bender Wirth: 632b Hekla XL</p> |  |  |
| <p></p> <p>LED Vesta DTW 9mm (4W/6W/12W) FWHM / FWTM 32.0° / 55.0° Efficiency 93 % Peak intensity 2.6 cd/lm LEDs/each optic 1 Light colour White Required components: Bender Wirth: 652b Hekla</p> |  |  |
| <p>CITIZEN</p> <p>LED CLL02x/CLU02x (LES10) FWHM / FWTM 33.0° / 56.0° Efficiency 86 % Peak intensity 2.3 cd/lm LEDs/each optic 1 Light colour White Required components: F17435_HEKLA-G2-C</p> |  |  |

PHOTOMETRIC DATA (MEASURED):

CITIZEN

LED CLU700/701/702
 FWHM / FWTM 34.0° / 53.0°
 Efficiency 87 %
 Peak intensity 2.4 cd/m
 LEDs/each optic 1
 Light colour White
 Required components:
 F17435_HEKLA-G2-C

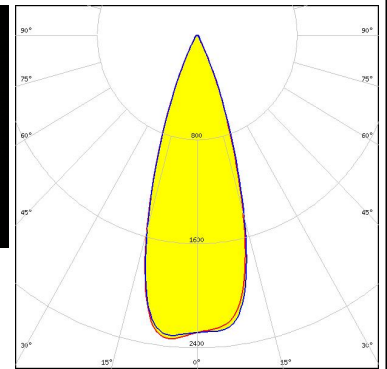
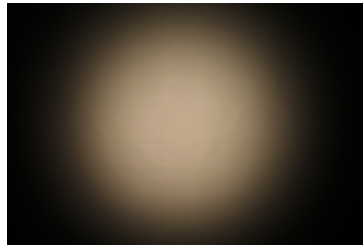

CITIZEN

LED CLU7A2 (LES 4.2mm)
 FWHM / FWTM 35.0° / 52.0°
 Efficiency 88 %
 Peak intensity 2.4 cd/m
 LEDs/each optic 1
 Light colour White
 Required components:
 F17435_HEKLA-G2-C

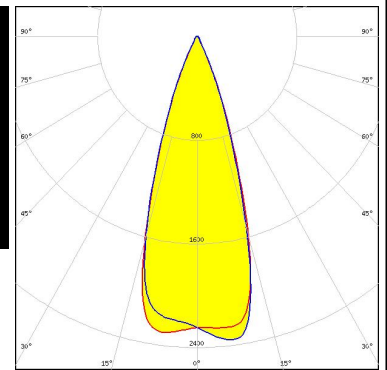
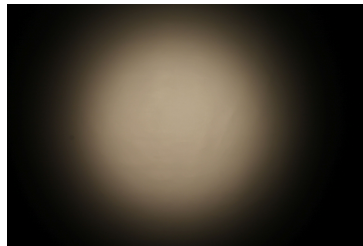

CITIZEN

LED CLU7B2
 FWHM / FWTM 34.0° / 51.0°
 Efficiency 88 %
 Peak intensity 2.4 cd/m
 LEDs/each optic 1
 Light colour White
 Required components:
 F17435_HEKLA-G2-C

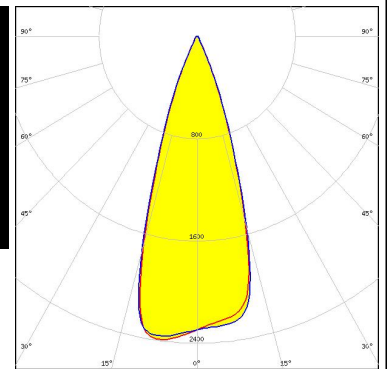
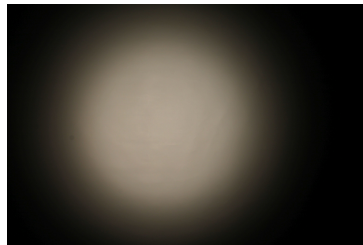

CREE LED

LED CMA1516
 FWHM / FWTM 33.0° / 55.0°
 Efficiency 87 %
 Peak intensity 2.4 cd/m
 LEDs/each optic 1
 Light colour White
 Required components:
 F17436_HEKLA-G2-D

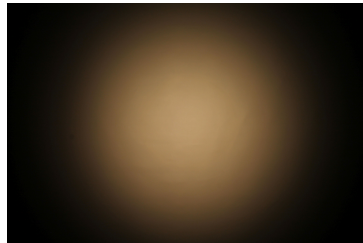

PHOTOMETRIC DATA (MEASURED):

CREE LED

LED CMT14xx
 FWHM / FWTM 33.0° / 56.0°
 Efficiency 86 %
 Peak intensity 2.3 cd/m
 LEDs/each optic 1
 Light colour White
 Required components:
 F17435_HEKLA-G2-C

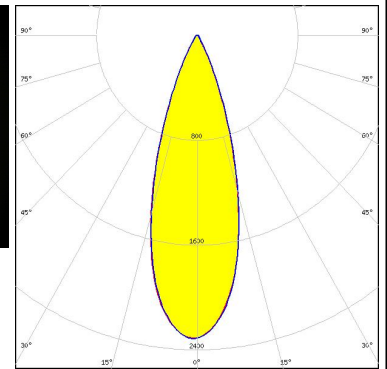
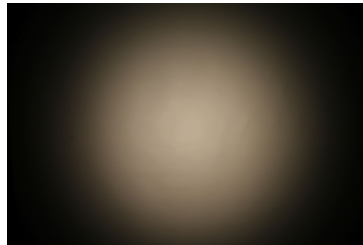

CREE LED

LED CXA/B 13xx
 FWHM / FWTM 34.0° / 53.0°
 Efficiency 89 %
 Peak intensity 2.4 cd/m
 LEDs/each optic 1
 Light colour White
 Required components:
 F17439_HEKLA-G2-J

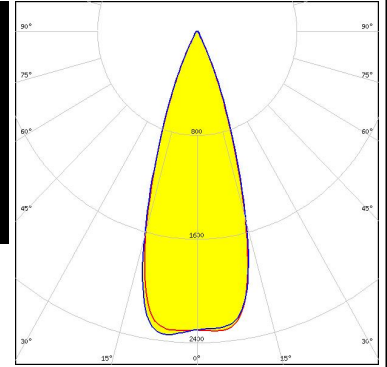

CREE LED

LED CXA/B 15xx
 FWHM / FWTM 33.0° / 55.0°
 Efficiency 87 %
 Peak intensity 2.4 cd/m
 LEDs/each optic 1
 Light colour White
 Required components:
 F17436_HEKLA-G2-D

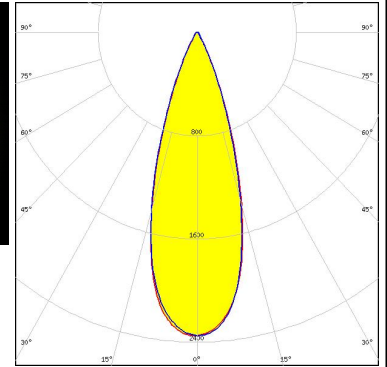
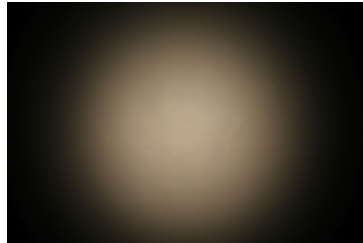

LUMILEDS

LED LUXEON CoB 1202/1203
 FWHM / FWTM 32.5° / 54.5°
 Efficiency 86 %
 Peak intensity 2.4 cd/m
 LEDs/each optic 1
 Light colour White
 Required components:
 F17437_HEKLA-G2-H

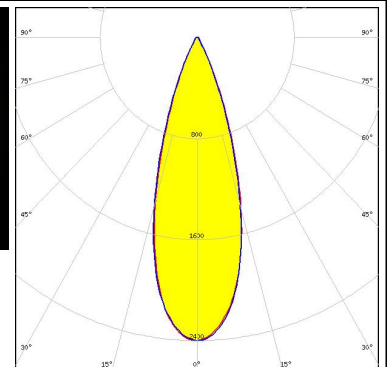
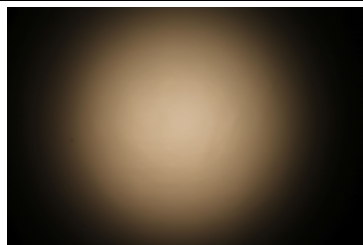

PHOTOMETRIC DATA (MEASURED):

LUMILEDS

LED LUXEON CoB 1204HD
 FWHM / FWTM 32.0° / 54.0°
 Efficiency 87 %
 Peak intensity 2.4 cd/m
 LEDs/each optic 1
 Light colour White
 Required components:
 F17437_HEKLA-G2-H

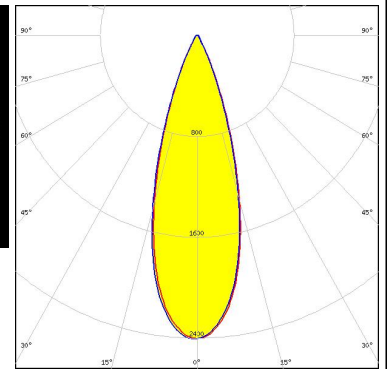
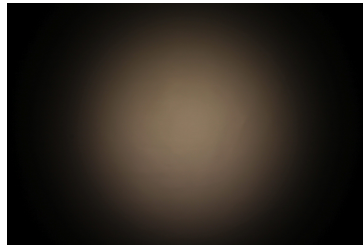

LUMILEDS

LED LUXEON CoB M02/M03
 FWHM / FWTM 33.0° / 54.0°
 Efficiency 87 %
 Peak intensity 2.4 cd/m
 LEDs/each optic 1
 Light colour White
 Required components:
 F17436_HEKLA-G2-D

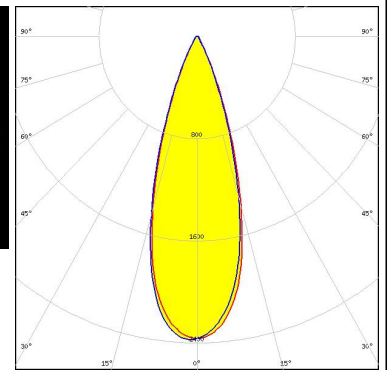
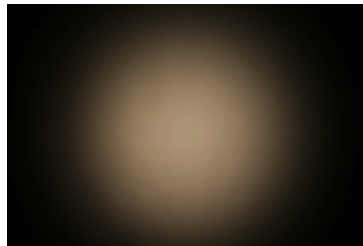

LUMILEDS

LED LUXEON CoB S01
 FWHM / FWTM 34.0° / 52.0°
 Efficiency 88 %
 Peak intensity 2.4 cd/m
 LEDs/each optic 1
 Light colour White
 Required components:
 F17439_HEKLA-G2-J

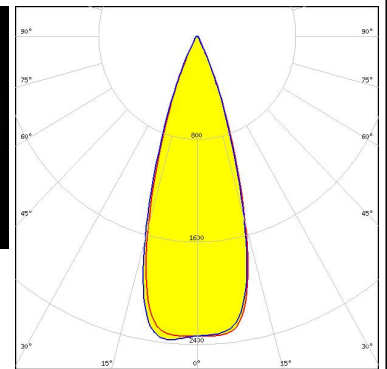
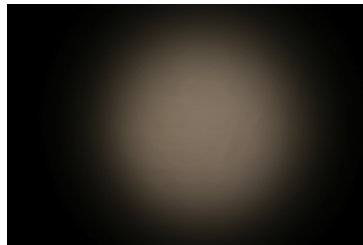

LUMINUS

LED CXM-3
 FWHM / FWTM 34.0° / 50.0°
 Efficiency 87 %
 Peak intensity 2.4 cd/m
 LEDs/each optic 1
 Light colour White
 Required components:
 F17435_HEKLA-G2-C

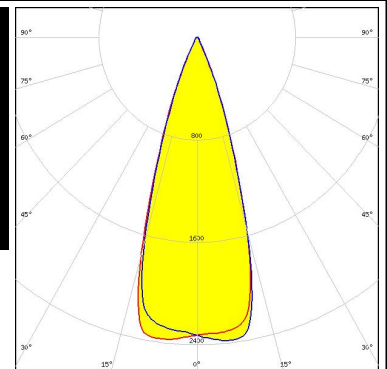
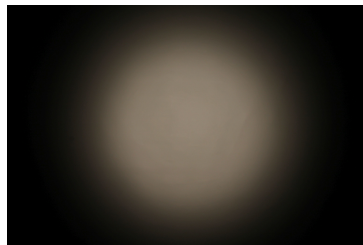

PHOTOMETRIC DATA (MEASURED):



LED CXM-4
 FWHM / FWTM 34.0° / 51.0°
 Efficiency 88 %
 Peak intensity 2.4 cd/lm
 LEDs/each optic 1
 Light colour White
 Required components:
 F17435_HEKLA-G2-C

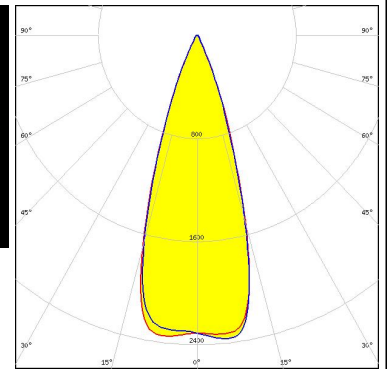
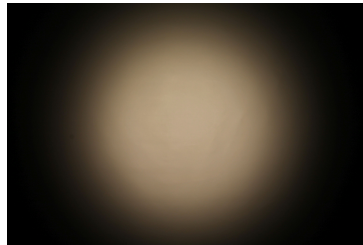

LED COB L-Type (LES 9)
 FWHM / FWTM 33.0° / 54.0°
 Efficiency 86 %
 Peak intensity 2.3 cd/lm
 LEDs/each optic 1
 Light colour White
 Required components:
 F17437_HEKLA-G2-H

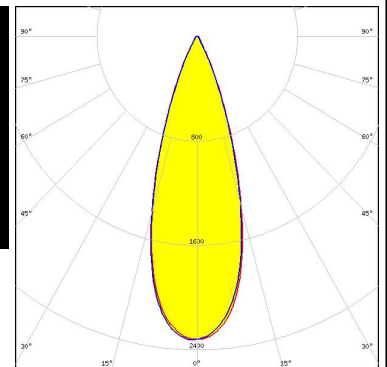
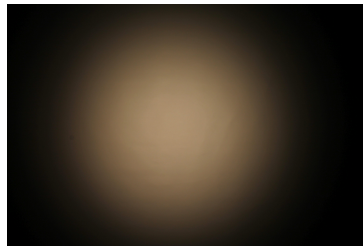

LED COB S-Type (LES 7)
 FWHM / FWTM 34.0° / 54.0°
 Efficiency 87 %
 Peak intensity 2.3 cd/lm
 LEDs/each optic 1
 Light colour White
 Required components:
 F15848_HEKLA-SOCKET-G

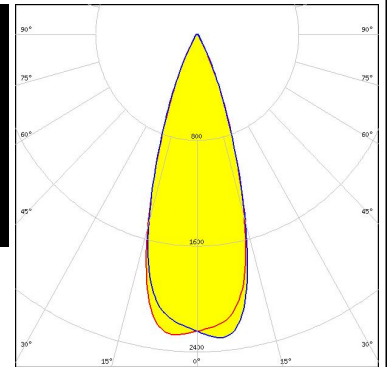
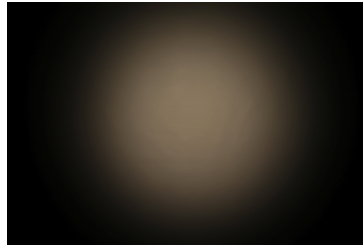

LED Fortimo SLM L09 CoB
 FWHM / FWTM 32.0° / 54.0°
 Efficiency 86 %
 Peak intensity 2.4 cd/lm
 LEDs/each optic 1
 Light colour White
 Required components:
 F17437_HEKLA-G2-H

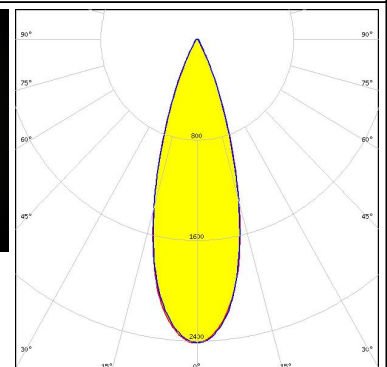
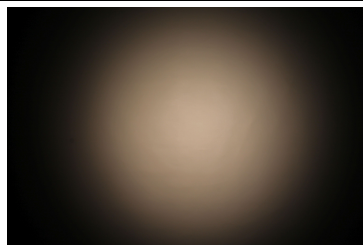

PHOTOMETRIC DATA (MEASURED):

SAMSUNG

LED LC003D / LC006D / LC009D / LC013D
 FWHM / FWTM 33.0° / 56.0°
 Efficiency 86 %
 Peak intensity 2.3 cd/m
 LEDs/each optic 1
 Light colour White
 Required components:
 F17435_HEKLA-G2-C

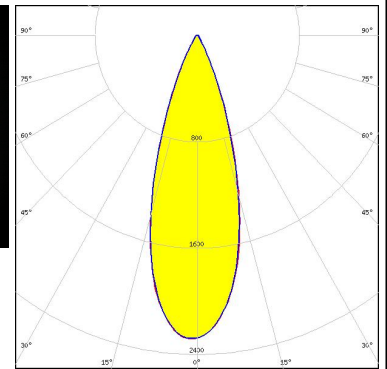
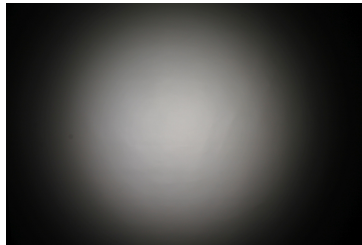

SEOUL SEMICONDUCTOR

LED MJT COB LES 6
 FWHM / FWTM 35.0° / 54.0°
 Efficiency 88 %
 Peak intensity 2.3 cd/m
 LEDs/each optic 1
 Light colour White
 Required components:
 F17435_HEKLA-G2-C

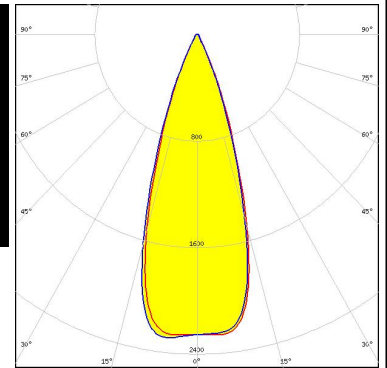
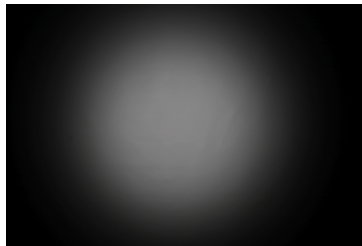

SEOUL SEMICONDUCTOR

LED MJT COB LES 9.8
 FWHM / FWTM 33.0° / 56.0°
 Efficiency 86 %
 Peak intensity 2.3 cd/m
 LEDs/each optic 1
 Light colour White
 Required components:
 F17435_HEKLA-G2-C

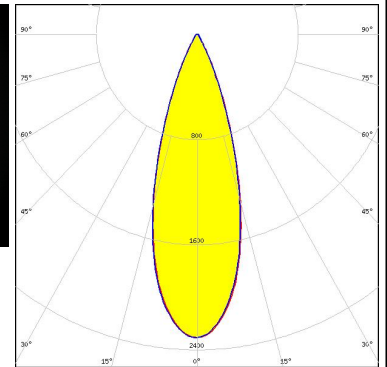
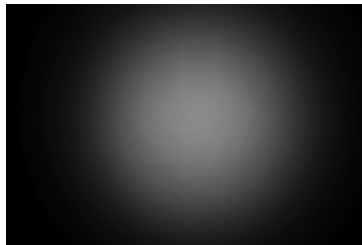

TRIDONIC

LED SLE G7 LES09
 FWHM / FWTM 33.0° / 55.0°
 Efficiency 87 %
 Peak intensity 2.4 cd/m
 LEDs/each optic 1
 Light colour White
 Required components:
 F17435_HEKLA-G2-C

