

YASMEEN-70-S-C-WHT

~15° spot beam. Assembly with holder C compatible with HEKLA sockets and connectors. White version.

TECHNICAL SPECIFICATIONS:

Dimensions	Ø 69.9 mm
Height	39.9 mm
ROHS compliant	yes ⓘ



MATERIAL SPECIFICATIONS:

Component	Type	Material	Colour	Finish
YASMEEN-70-S	Single lens	PMMA	clear	
YASMEEN-70-HLD-C-WHT	Holder	PC	white	





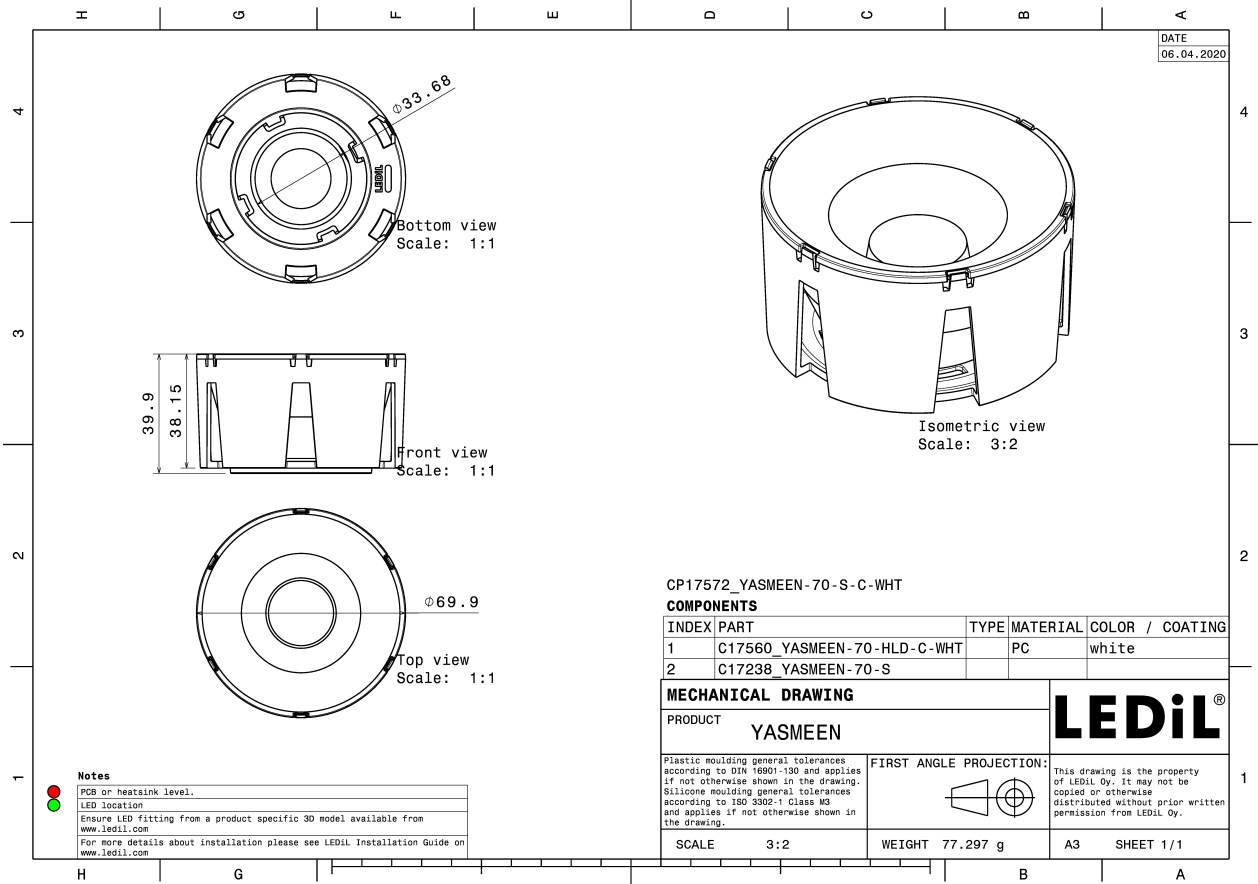



ORDERING INFORMATION:

Component	Type	Qty in box	MOQ	MPQ	Box weight (kg)
CP17572_YASMEEN-70-S-C-WHT » Box size: 476 x 273 x 305 mm	Single lens	105	105	15	9.8

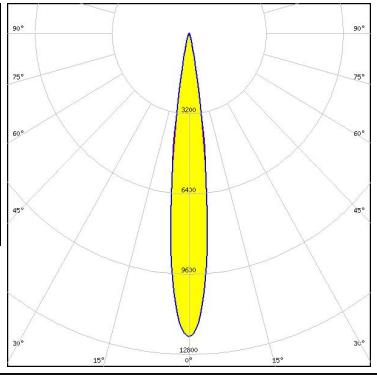

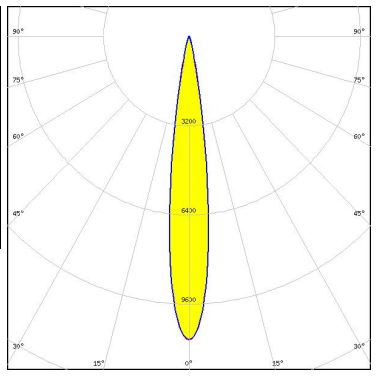
See also our general installation guide: www.ledil.com/installation_guide

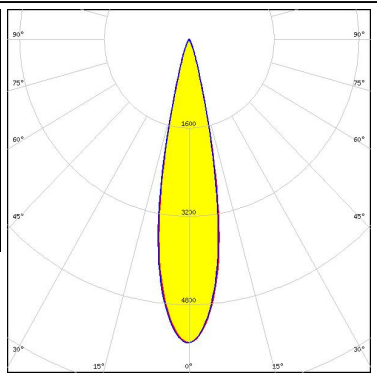
PHOTOMETRIC DATA (MEASURED):

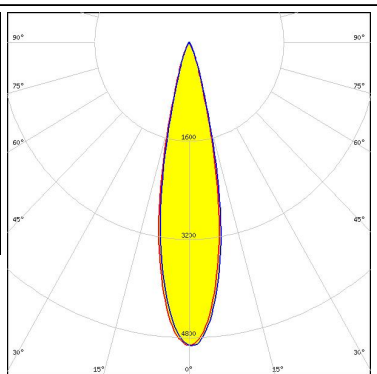
<p></p> <p>LED V9 HD FWHM / FWTM 13.0° / 24.0° Efficiency 92 % Peak intensity 12.1 cd/lm LEDs/each optic 1 Light colour White Required components: F15859_HEKLA-SOCKET-I</p>		
<p></p> <p>LED VERO10 FWHM / FWTM 14.0° / 25.0° Efficiency 93 % Peak intensity 10.9 cd/lm LEDs/each optic 1 Light colour White Required components: F15616_HEKLA-SOCKET-F</p>		
<p></p> <p>LED Vesta DTW 13mm (21W) FWHM / FWTM 22.0° / 36.0° Efficiency 92 % Peak intensity 5.5 cd/lm LEDs/each optic 1 Light colour Tunable White Required components: Bender Wirth: 632b Hekla</p>		
<p></p> <p>LED Vesta DTW 15mm (33W) FWHM / FWTM 23.0° / 39.0° Efficiency 92 % Peak intensity 4.9 cd/lm LEDs/each optic 1 Light colour Tunable White Required components: Bender Wirth: 632b Hekla</p>		

PHOTOMETRIC DATA (MEASURED):



LED Vesta DTW 9mm (4W/6W/12W)
 FWHM / FWTM 15.0° / 25.0°
 Efficiency 93 %
 Peak intensity 11 cd/lm
 LEDs/each optic 1
 Light colour Tunable White
 Required components:
 Bender Wirth: 652b Hekla

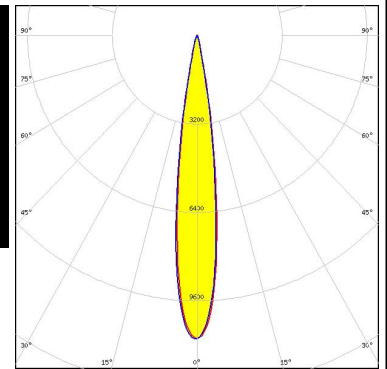

CITIZEN

LED CLL02x/CLU02x (LES10)
 FWHM / FWTM 15.5° / 26.5°
 Efficiency 92 %
 Peak intensity 10 cd/lm
 LEDs/each optic 1
 Light colour White
 Required components:
 F17435_HEKLA-G2-C

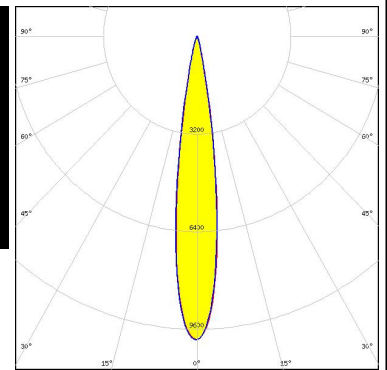
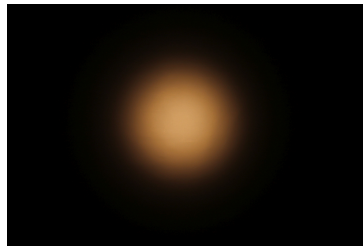

CITIZEN

LED CLL03x/CLU03x
 FWHM / FWTM 21.0° / 37.0°
 Efficiency 92 %
 Peak intensity 5.6 cd/lm
 LEDs/each optic 1
 Light colour White
 Required components:
 F17438_HEKLA-G2-I

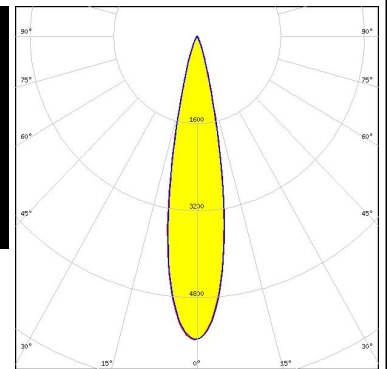

LED CMA1516
 FWHM / FWTM 14.0° / 25.0°
 Efficiency 93 %
 Peak intensity 10.9 cd/lm
 LEDs/each optic 1
 Light colour White
 Required components:
 F17436_HEKLA-G2-D

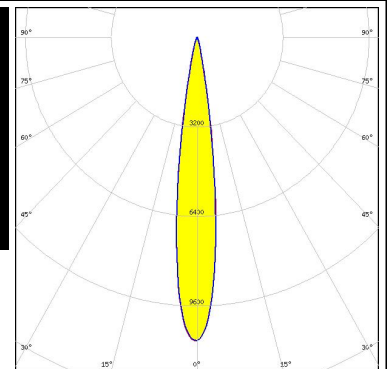

PHOTOMETRIC DATA (MEASURED):

CREE LED

LED CMA1825
 FWHM / FWTM 19.0° / 32.0°
 Efficiency 93 %
 Peak intensity 6.9 cd/lm
 LEDs/each optic 1
 Light colour White
 Required components:
 F15254_HEKLA-SOCKET-B

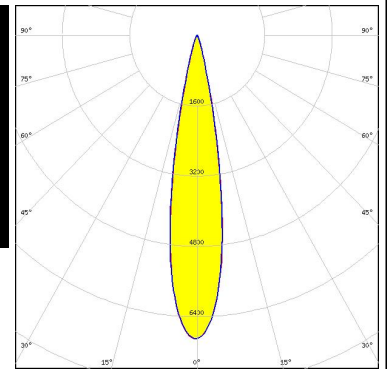

CREE LED

LED CMT14xx
 FWHM / FWTM 15.0° / 26.0°
 Efficiency 92 %
 Peak intensity 10.1 cd/lm
 LEDs/each optic 1
 Light colour White
 Required components:
 F17435_HEKLA-G2-C

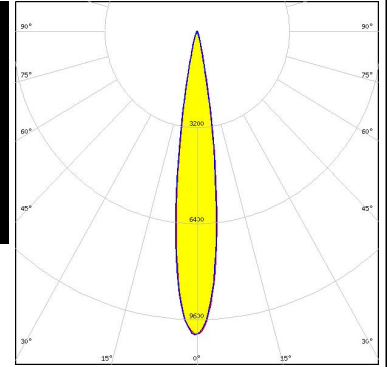

CREE LED

LED CMT19xx
 FWHM / FWTM 21.0° / 36.0°
 Efficiency 92 %
 Peak intensity 5.4 cd/lm
 LEDs/each optic 1
 Light colour White
 Required components:
 F17438_HEKLA-G2-I

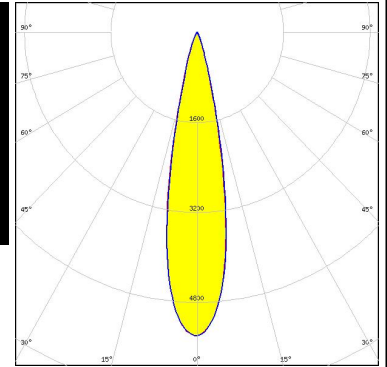

LUMILEDS

LED LUXEON CoB 1202/1203
 FWHM / FWTM 14.0° / 24.0°
 Efficiency 92 %
 Peak intensity 11.2 cd/lm
 LEDs/each optic 1
 Light colour White
 Required components:
 F17437_HEKLA-G2-H

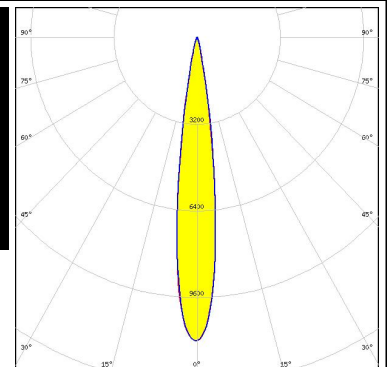

PHOTOMETRIC DATA (MEASURED):



LED COB L-Type (LES 9)
FWHM / FWTM 13.0° / 24.0°
Efficiency 92 %
Peak intensity 11.9 cd/lm
LEDs/each optic 1
Light colour White
Required components:
 F17437_HEKLA-G2-H

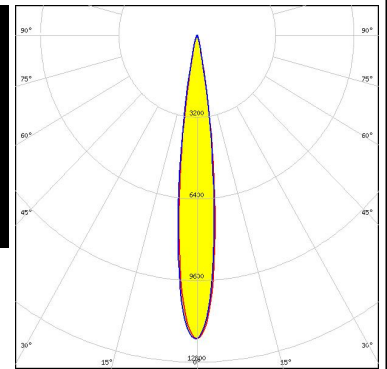
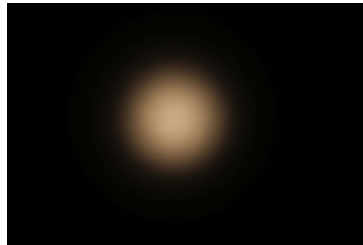

LED COB S-Type (LES 7)
FWHM / FWTM 20.0° / 34.0°
Efficiency 92 %
Peak intensity 6.1 cd/lm
LEDs/each optic 1
Light colour White
Required components:
 F17438_HEKLA-G2-I

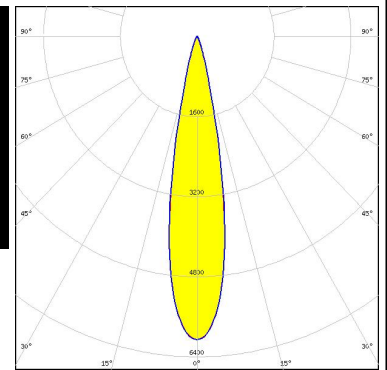

LED Fortimo SLM L09 CoB
FWHM / FWTM 14.0° / 25.0°
Efficiency 92 %
Peak intensity 11.1 cd/lm
LEDs/each optic 1
Light colour White
Required components:
 F17437_HEKLA-G2-H

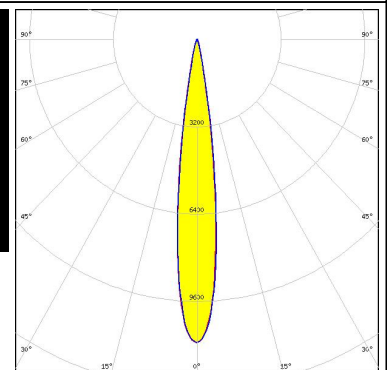

LED LC016D / LC019D / LC026D / LC033D
FWHM / FWTM 23.0° / 40.0°
Efficiency 92 %
Peak intensity 4.8 cd/lm
LEDs/each optic 1
Light colour White
Required components:
 F17438_HEKLA-G2-I

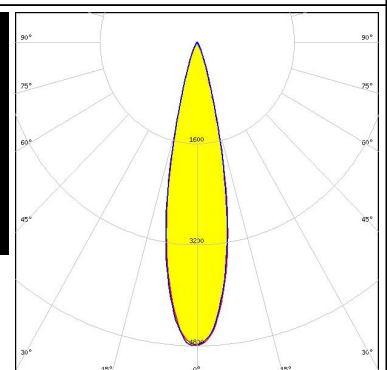
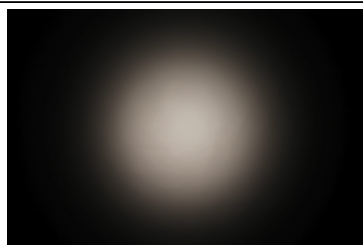

PHOTOMETRIC DATA (MEASURED):

SAMSUNG

LED LC030C/040C G2
 FWHM / FWTM 17.0° / 30.0°
 Efficiency 92 %
 Peak intensity 7.7 cd/lm
 LEDs/each optic 1
 Light colour White
 Required components:
 F17438_HEKLA-G2-I

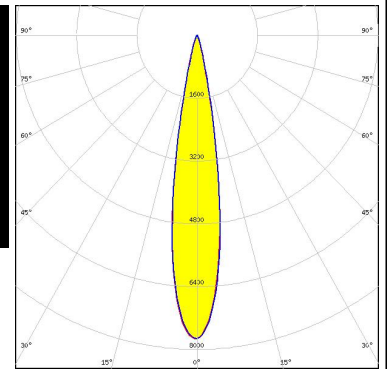

LED MJT COB LES 14.5
 FWHM / FWTM 23.0° / 39.0°
 Efficiency 92 %
 Peak intensity 4.9 cd/lm
 LEDs/each optic 1
 Light colour White
 Required components:
 F17438_HEKLA-G2-I

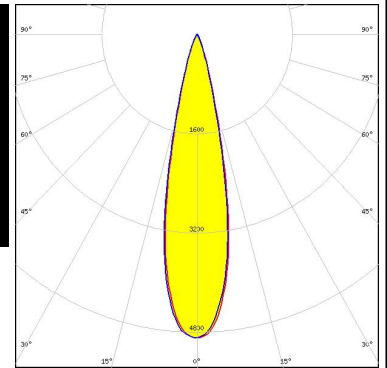
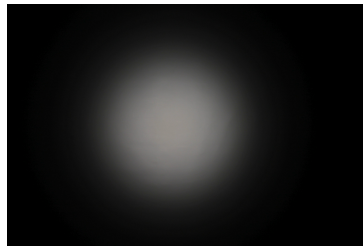

TRIDONIC

LED SLE G7 LES09
 FWHM / FWTM 15.0° / 25.0°
 Efficiency 93 %
 Peak intensity 11.3 cd/lm
 LEDs/each optic 1
 Light colour White
 Required components:
 F17435_HEKLA-G2-C

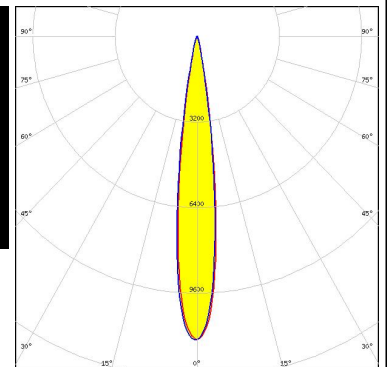

TRIDONIC

LED SLE G7 LES15
 FWHM / FWTM 22.0° / 38.0°
 Efficiency 92 %
 Peak intensity 5.1 cd/lm
 LEDs/each optic 1
 Light colour White
 Required components:
 F17438_HEKLA-G2-I

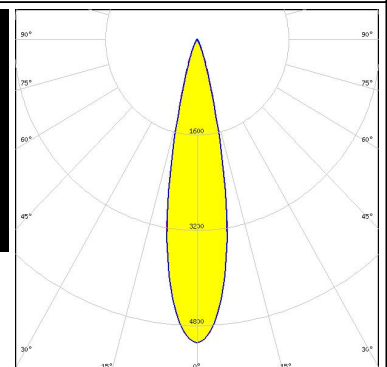

PHOTOMETRIC DATA (SIMULATED):

CITIZEN

LED CLU712
FWHM / FWTM 14.0° / 26.0°
Efficiency 93 %
Peak intensity 11.3 cd/lm
LEDs/each optic 1
Light colour White
Required components:
F17438_HEKLA-G2-I

