

YASMEEN-70-M-C-WHT

~26° spot beam. Assembly with holder C compatible with HEKLA sockets and connectors. White version.

TECHNICAL SPECIFICATIONS:

Dimensions	Ø 69.9 mm
Height	39.9 mm
ROHS compliant	yes ⓘ



MATERIAL SPECIFICATIONS:

Component	Type	Material	Colour	Finish
YASMEEN-70-M	Single lens	PMMA	clear	
YASMEEN-70-HLD-C-WHT	Holder	PC	white	





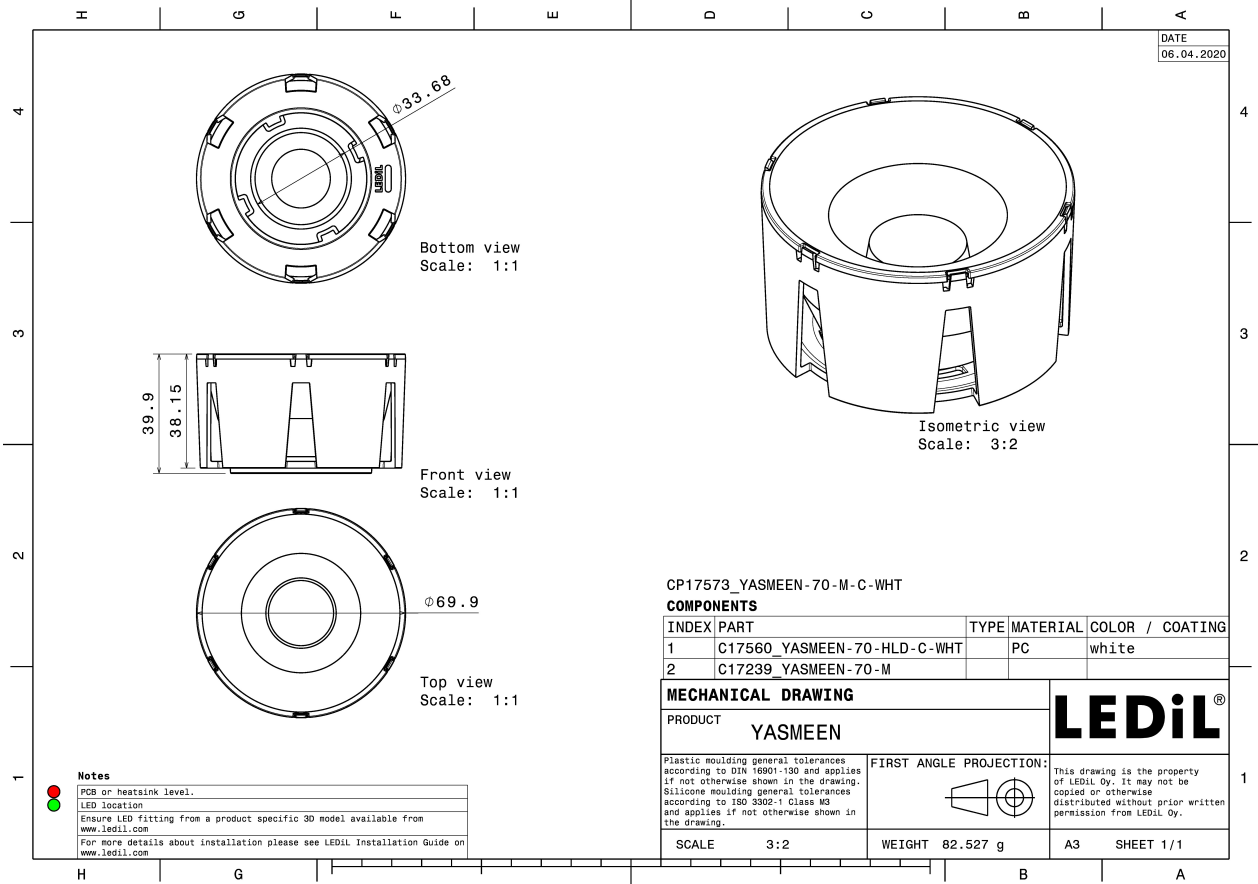



ORDERING INFORMATION:

Component	Type	Qty in box	MOQ	MPQ	Box weight (kg)
CP17573_YASMEEN-70-M-C-WHT	Single lens	105	105	15	10.0
» Box size: 476 x 273 x 305 mm					

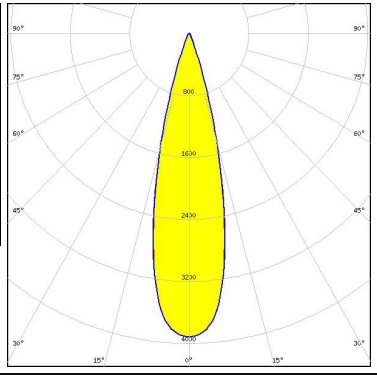

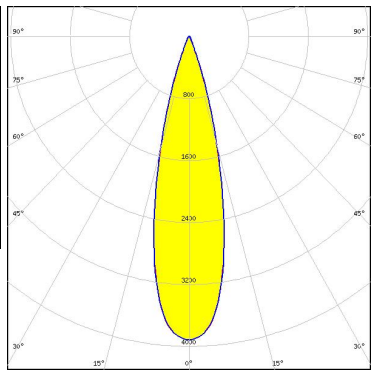
See also our general installation guide: www.ledil.com/installation_guide

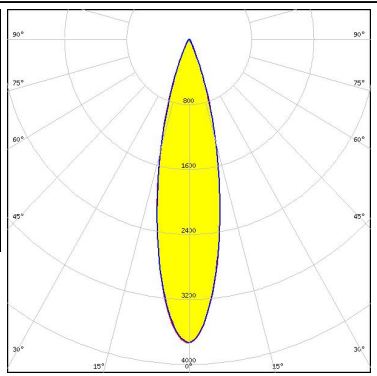
PHOTOMETRIC DATA (MEASURED):

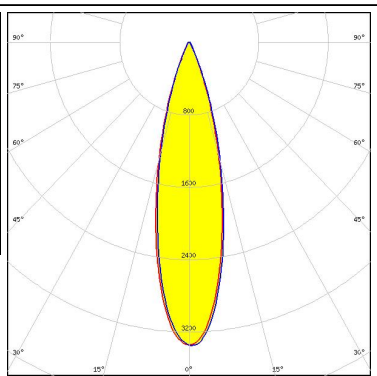
<p></p> <p>LED V9 HD</p> <p>FWHM / FWTM 26.0° / 41.0°</p> <p>Efficiency 89 %</p> <p>Peak intensity 3.9 cd/m</p> <p>LEDs/each optic 1</p> <p>Light colour White</p> <p>Required components: F15859_HEKLA-SOCKET-I</p>		
<p></p> <p>LED VERO10</p> <p>FWHM / FWTM 26.0° / 42.0°</p> <p>Efficiency 90 %</p> <p>Peak intensity 3.9 cd/m</p> <p>LEDs/each optic 1</p> <p>Light colour White</p> <p>Required components: F15616_HEKLA-SOCKET-F</p>		
<p></p> <p>LED Vesta DTW 13mm (21W)</p> <p>FWHM / FWTM 25.0° / 46.0°</p> <p>Efficiency 90 %</p> <p>Peak intensity 3.7 cd/m</p> <p>LEDs/each optic 1</p> <p>Light colour Tunable White</p> <p>Required components: Bender Wirth: 632b Hekla</p>		
<p></p> <p>LED Vesta DTW 15mm (33W)</p> <p>FWHM / FWTM 26.0° / 48.0°</p> <p>Efficiency 89 %</p> <p>Peak intensity 3.4 cd/m</p> <p>LEDs/each optic 1</p> <p>Light colour Tunable White</p> <p>Required components: Bender Wirth: 632b Hekla</p>		

PHOTOMETRIC DATA (MEASURED):



LED Vesta DTW 9mm (4W/6W/12W)
 FWHM / FWTM 26.0° / 43.0°
 Efficiency 91 %
 Peak intensity 3.9 cd/lm
 LEDs/each optic 1
 Light colour White
 Required components:
 Bender Wirth: 652b Hekla

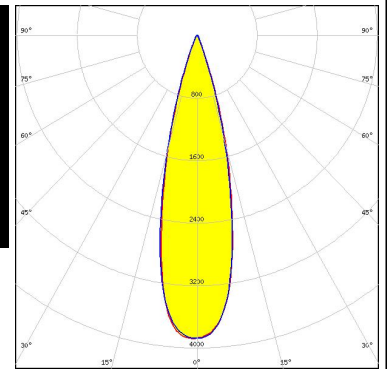
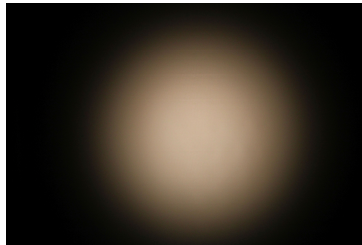

CITIZEN

LED CLL02x/CLU02x (LES10)
 FWHM / FWTM 25.5° / 42.5°
 Efficiency 89 %
 Peak intensity 3.9 cd/lm
 LEDs/each optic 1
 Light colour White
 Required components:
 F17435_HEKLA-G2-C

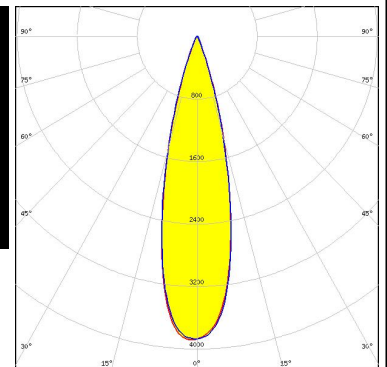
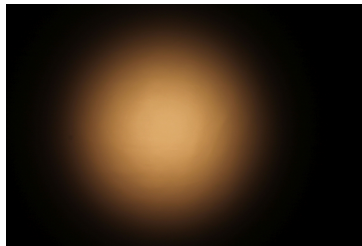

CITIZEN

LED CLL03x/CLU03x
 FWHM / FWTM 24.5° / 45.5°
 Efficiency 89 %
 Peak intensity 3.7 cd/lm
 LEDs/each optic 1
 Light colour White
 Required components:
 F17438_HEKLA-G2-I

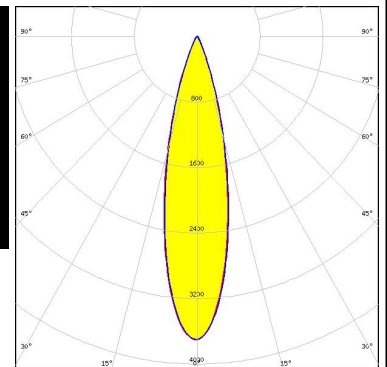
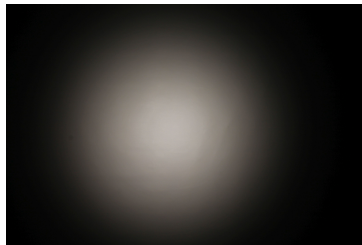

LED CMA1516
 FWHM / FWTM 26.0° / 42.0°
 Efficiency 90 %
 Peak intensity 3.9 cd/lm
 LEDs/each optic 1
 Light colour White
 Required components:
 F17436_HEKLA-G2-D

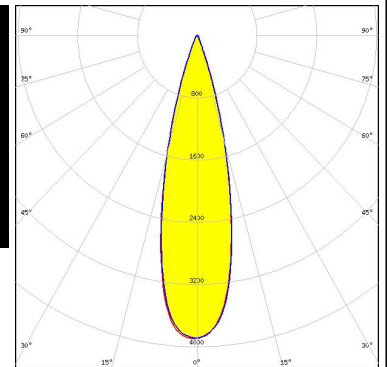
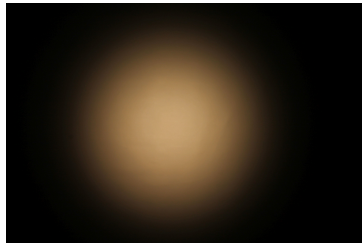

PHOTOMETRIC DATA (MEASURED):

CREE LED

LED CMA1825
 FWHM / FWTM 25.0° / 44.0°
 Efficiency 90 %
 Peak intensity 3.8 cd/m
 LEDs/each optic 1
 Light colour White
 Required components:
 F15254_HEKLA-SOCKET-B

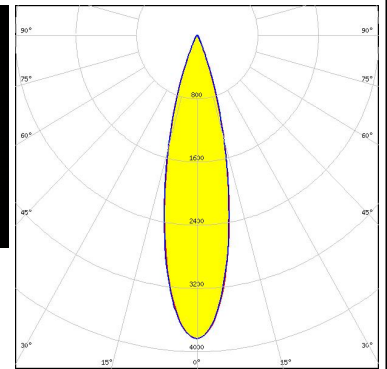
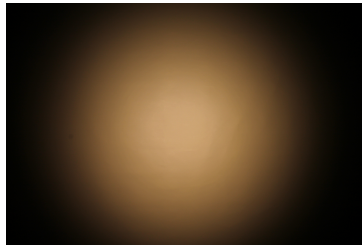

CREE LED

LED CMT14xx
 FWHM / FWTM 26.0° / 43.0°
 Efficiency 90 %
 Peak intensity 3.8 cd/m
 LEDs/each optic 1
 Light colour White
 Required components:
 F17435_HEKLA-G2-C

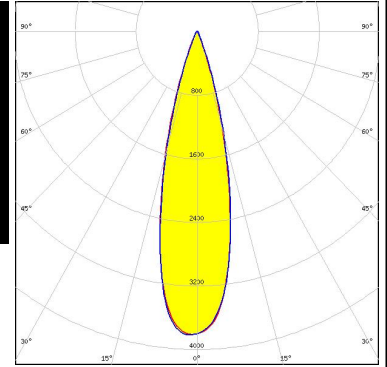

CREE LED

LED CMT19xx
 FWHM / FWTM 25.0° / 46.0°
 Efficiency 89 %
 Peak intensity 3.7 cd/m
 LEDs/each optic 1
 Light colour White
 Required components:
 F17438_HEKLA-G2-I

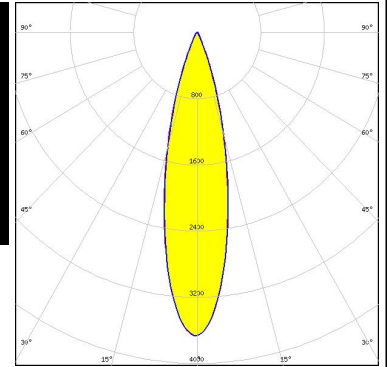
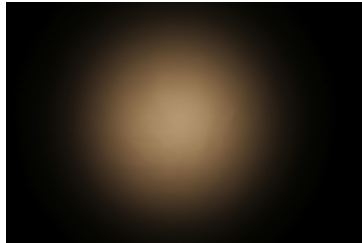

LUMILEDS

LED LUXEON CoB 1202/1203
 FWHM / FWTM 26.0° / 42.0°
 Efficiency 90 %
 Peak intensity 3.9 cd/m
 LEDs/each optic 1
 Light colour White
 Required components:
 F17437_HEKLA-G2-H

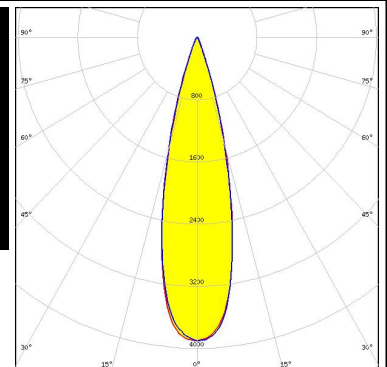

PHOTOMETRIC DATA (MEASURED):



LED COB L-Type (LES 11)
 FWHM / FWTM 25.0° / 43.0°
 Efficiency 89 %
 Peak intensity 3.9 cd/m
 LEDs/each optic 1
 Light colour White
 Required components:
 F17437_HEKLA-G2-H

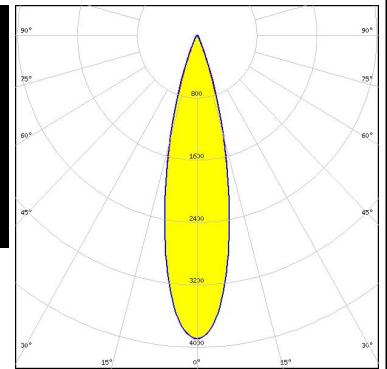

LED COB L-Type (LES 9)
 FWHM / FWTM 26.0° / 42.0°
 Efficiency 89 %
 Peak intensity 3.8 cd/m
 LEDs/each optic 1
 Light colour White
 Required components:
 F17437_HEKLA-G2-H

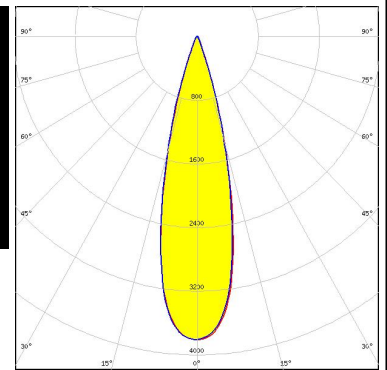
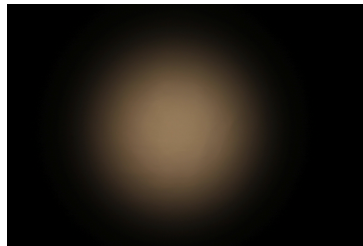

LED COB S-Type (LES 7)
 FWHM / FWTM 24.0° / 44.0°
 Efficiency 89 %
 Peak intensity 3.8 cd/m
 LEDs/each optic 1
 Light colour White
 Required components:
 F17438_HEKLA-G2-I

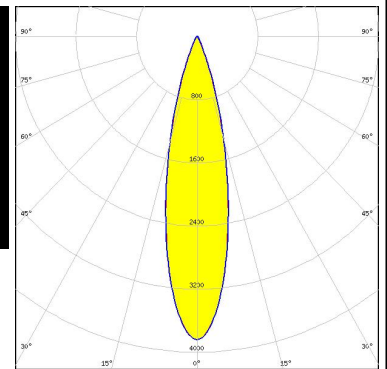
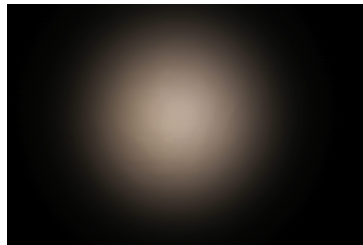

LED Fortimo SLM L09 CoB
 FWHM / FWTM 26.0° / 41.0°
 Efficiency 90 %
 Peak intensity 3.9 cd/m
 LEDs/each optic 1
 Light colour White
 Required components:
 F17437_HEKLA-G2-H

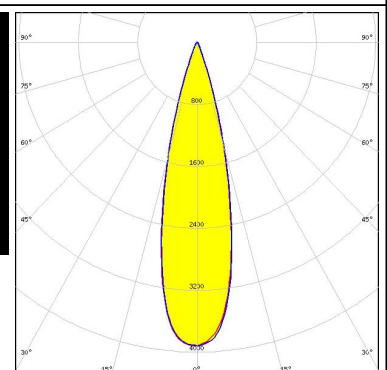
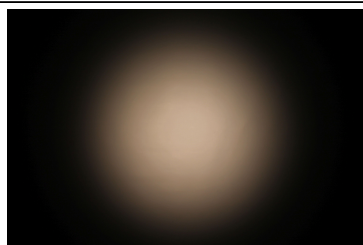

PHOTOMETRIC DATA (MEASURED):

SAMSUNG

LED LC016D / LC019D / LC026D / LC033D
 FWHM / FWTM 26.0° / 47.0°
 Efficiency 89 %
 Peak intensity 3.4 cd/m
 LEDs/each optic 1
 Light colour White
 Required components:
 F17438_HEKLA-G2-I

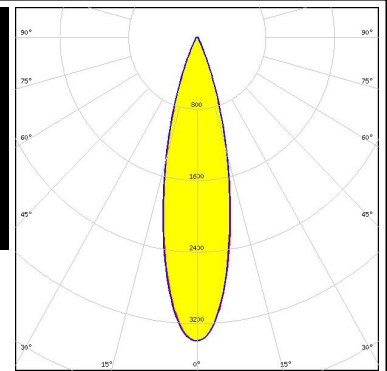
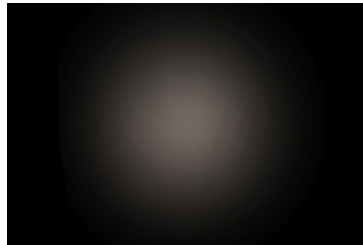

SAMSUNG

LED LC030C/040C G2
 FWHM / FWTM 24.0° / 43.0°
 Efficiency 90 %
 Peak intensity 3.9 cd/m
 LEDs/each optic 1
 Light colour White
 Required components:
 F17438_HEKLA-G2-I

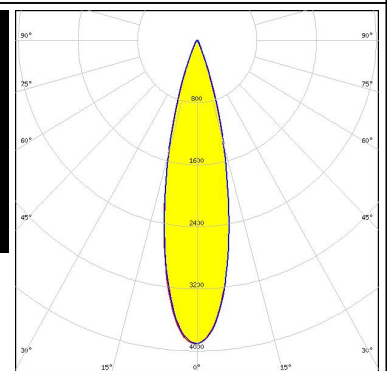
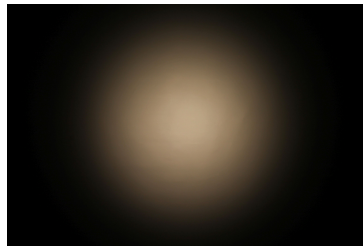

LED MJT COB LES 14.5
 FWHM / FWTM 25.0° / 46.0°
 Efficiency 89 %
 Peak intensity 3.6 cd/m
 LEDs/each optic 1
 Light colour White
 Required components:
 F17438_HEKLA-G2-I

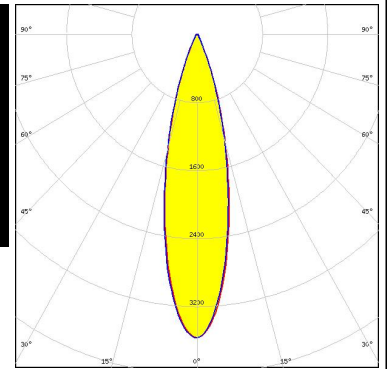
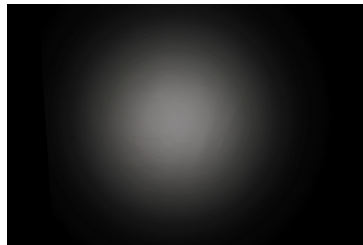

TRIDONIC

LED SLE G7 LES09
 FWHM / FWTM 26.0° / 41.0°
 Efficiency 90 %
 Peak intensity 3.9 cd/m
 LEDs/each optic 1
 Light colour White
 Required components:
 F17435_HEKLA-G2-C

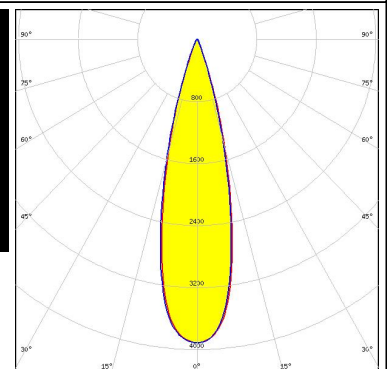
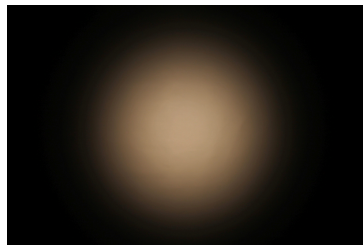

PHOTOMETRIC DATA (MEASURED):

TRIDONIC

LED SLE G7 LES15
FWHM / FWTM 25.0° / 46.0°
Efficiency 90 %
Peak intensity 3.6 cd/lm
LEDs/each optic 1
Light colour White
Required components:
F17438_HEKLA-G2-I

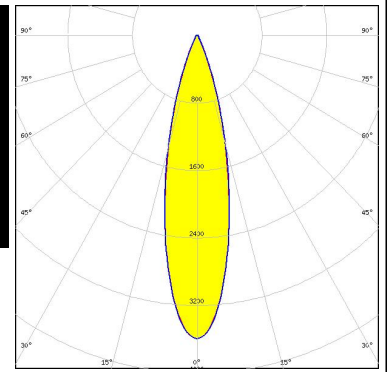
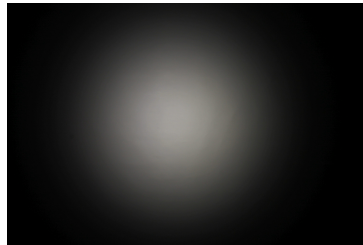

PHOTOMETRIC DATA (SIMULATED):

CITIZEN

LED	CLU712
FWHM / FWTM	28.0° / 43.0°
Efficiency	92 %
Peak intensity	3.9 cd/lm
LEDs/each optic	1
Light colour	White
Required components:	
F17438_HEKLA-G2-I	

