

YASMEEN-70-WW-C-WHT

~60° wide beam. Assembly with holder C compatible with HEKLA sockets and connectors. White version.

TECHNICAL SPECIFICATIONS:

Dimensions	Ø 69.9 mm
Height	39.9 mm
ROHS compliant	yes ⓘ

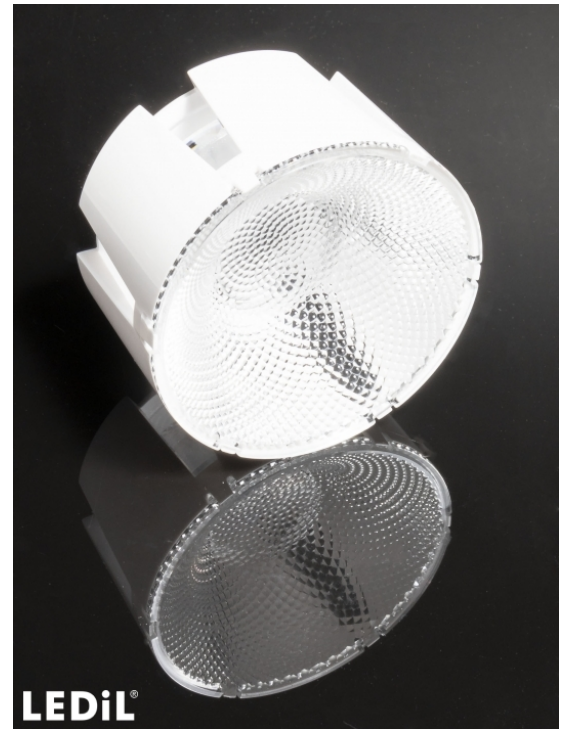

MATERIAL SPECIFICATIONS:

Component	Type	Material	Colour	Finish
YASMEEN-70-WW	Single lens	PMMA	clear	
YASMEEN-70-HLD-C-WHT	Holder	PC	white	



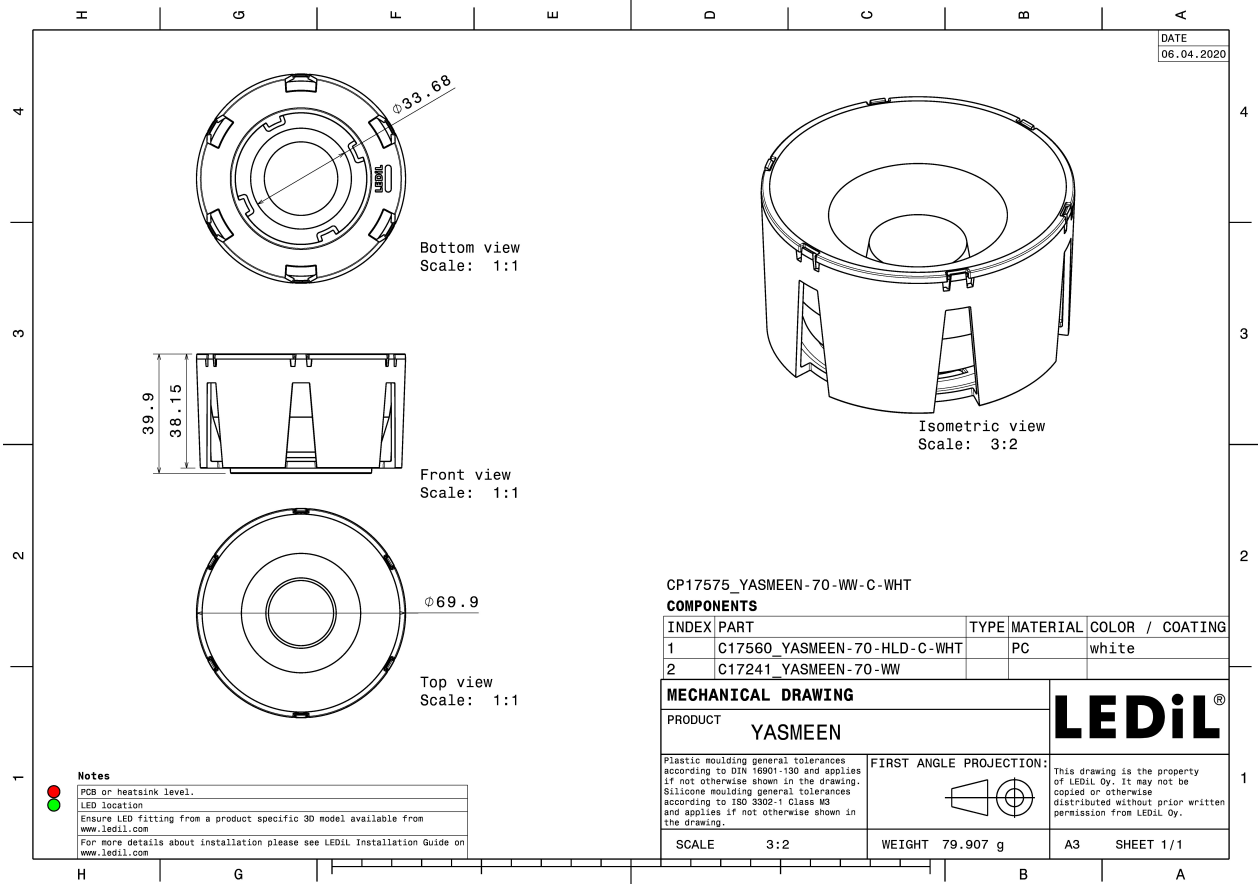

ORDERING INFORMATION:

Component	Type	Qty in box	MOQ	MPQ	Box weight (kg)
CP17575_YASMEEN-70-WW-C-WHT	Single lens	105	105	15	9.8
» Box size: 476 x 273 x 305 mm					

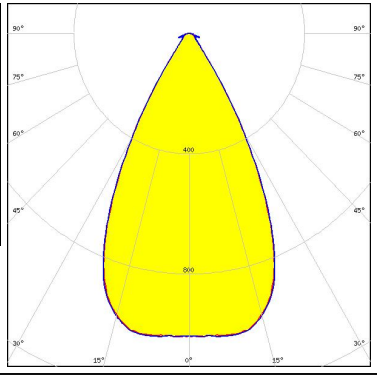
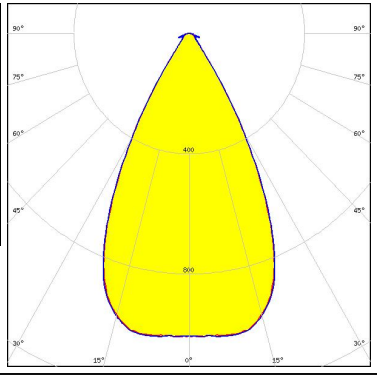
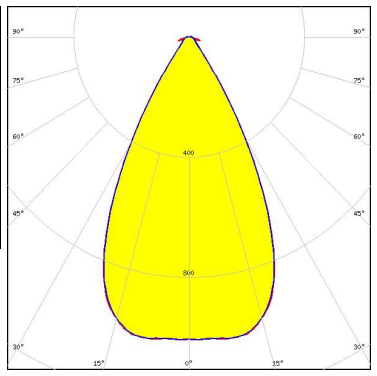
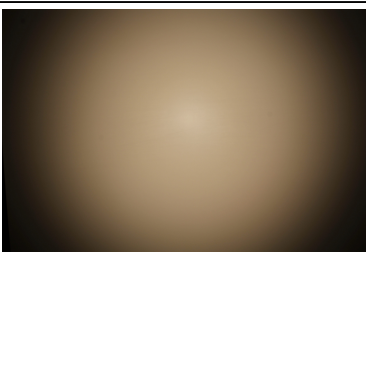
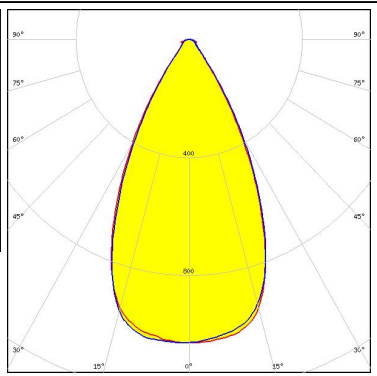

See also our general installation guide: www.ledil.com/installation_guide

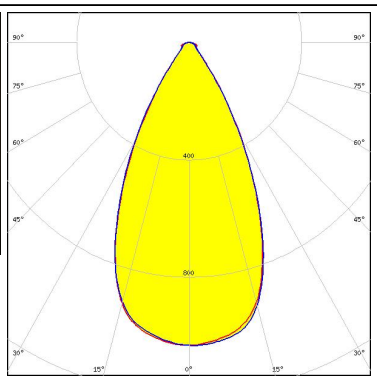
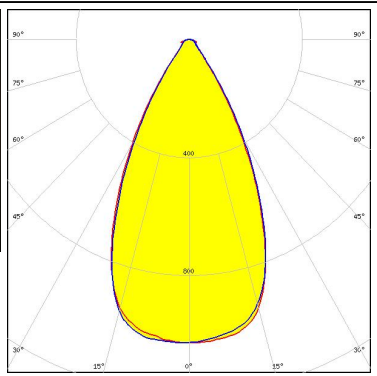
PHOTOMETRIC DATA (MEASURED):

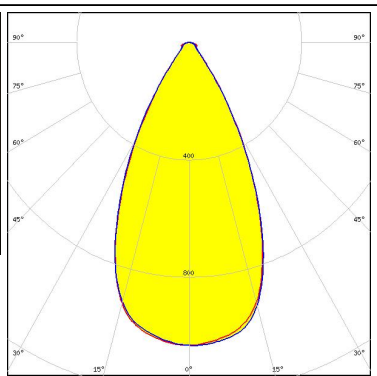
<p></p> <p>LED V9 HD</p> <p>FWHM / FWTM 55.0° / 76.0°</p> <p>Efficiency 89 %</p> <p>Peak intensity 1 cd/lm</p> <p>LEDs/each optic 1</p> <p>Light colour White</p> <p>Required components: F15859_HEKLA-SOCKET-I</p>		
<p></p> <p>LED VERO10</p> <p>FWHM / FWTM 55.5° / 76.5°</p> <p>Efficiency 90 %</p> <p>Peak intensity 1 cd/lm</p> <p>LEDs/each optic 1</p> <p>Light colour White</p> <p>Required components: F15616_HEKLA-SOCKET-F</p>		
<p></p> <p>LED Vesta DTW 13mm (21W)</p> <p>FWHM / FWTM 54.0° / 79.0°</p> <p>Efficiency 89 %</p> <p>Peak intensity 1 cd/lm</p> <p>LEDs/each optic 1</p> <p>Light colour Tunable White</p> <p>Required components: Bender Wirth: 632b Hekla</p>		
<p></p> <p>LED Vesta DTW 15mm (33W)</p> <p>FWHM / FWTM 52.0° / 80.0°</p> <p>Efficiency 88 %</p> <p>Peak intensity 1 cd/lm</p> <p>LEDs/each optic 1</p> <p>Light colour Tunable White</p> <p>Required components: Bender Wirth: 632b Hekla</p>		

PHOTOMETRIC DATA (MEASURED):



LED Vesta DTW 9mm (4W/6W/12W)
 FWHM / FWTM 56.0° / 77.0°
 Efficiency 90 %
 Peak intensity 1 cd/lm
 LEDs/each optic 1
 Light colour White
 Required components:
 Bender Wirth: 652b Hekla

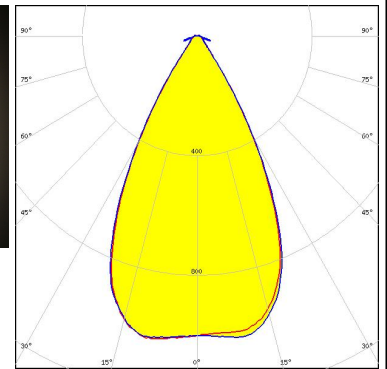
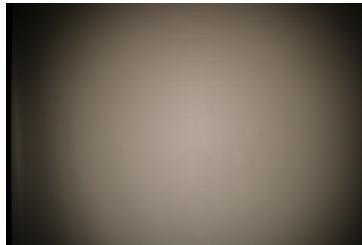

CITIZEN

LED CLL02x/CLU02x (LES10)
 FWHM / FWTM 55.0° / 77.0°
 Efficiency 90 %
 Peak intensity 1 cd/lm
 LEDs/each optic 1
 Light colour White
 Required components:
 F17435_HEKLA-G2-C

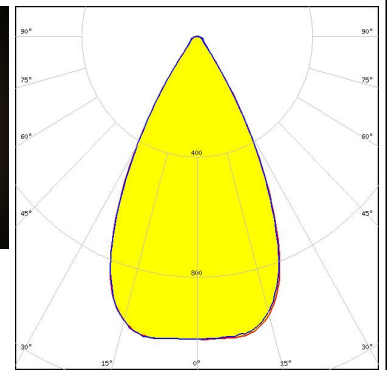
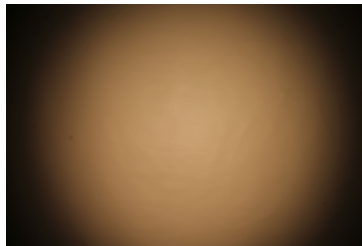

CITIZEN

LED CLL03x/CLU03x
 FWHM / FWTM 52.0° / 78.0°
 Efficiency 89 %
 Peak intensity 1.1 cd/lm
 LEDs/each optic 1
 Light colour White
 Required components:
 F17435_HEKLA-G2-C

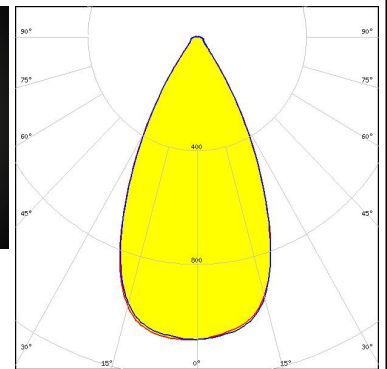
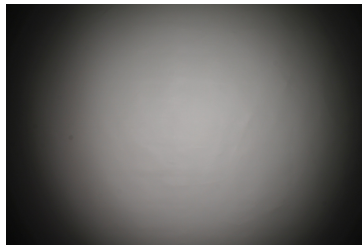

LED CMA1516
 FWHM / FWTM 55.0° / 77.0°
 Efficiency 90 %
 Peak intensity 1 cd/lm
 LEDs/each optic 1
 Light colour White
 Required components:
 F17436_HEKLA-G2-D

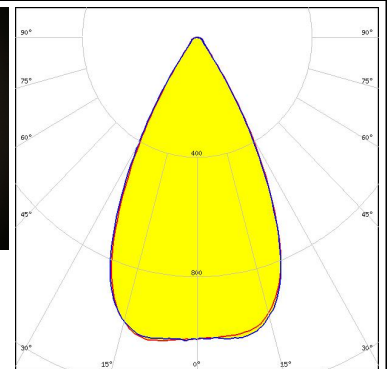
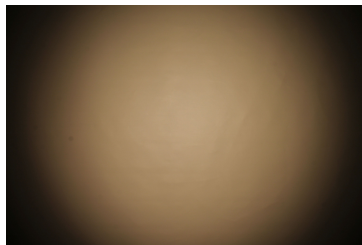

PHOTOMETRIC DATA (MEASURED):

CREE LED

LED CMA1825
 FWHM / FWTM 54.0° / 78.0°
 Efficiency 90 %
 Peak intensity 1 cd/lm
 LEDs/each optic 1
 Light colour White
 Required components:
 F15254_HEKLA-SOCKET-B

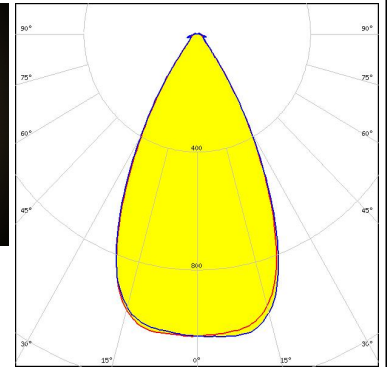
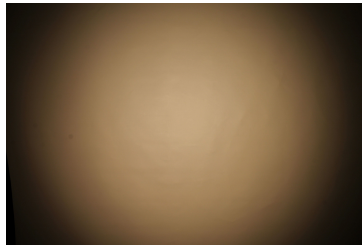

CREE LED

LED CMT14xx
 FWHM / FWTM 55.0° / 77.0°
 Efficiency 90 %
 Peak intensity 1 cd/lm
 LEDs/each optic 1
 Light colour White
 Required components:
 F17435_HEKLA-G2-C

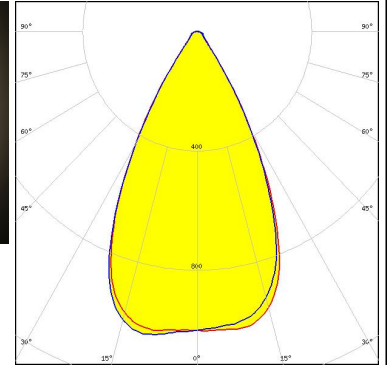

CREE LED

LED CMT19xx
 FWHM / FWTM 52.0° / 78.0°
 Efficiency 89 %
 Peak intensity 1.1 cd/lm
 LEDs/each optic 1
 Light colour White
 Required components:
 F17438_HEKLA-G2-I

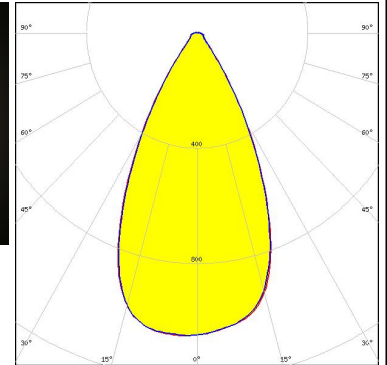
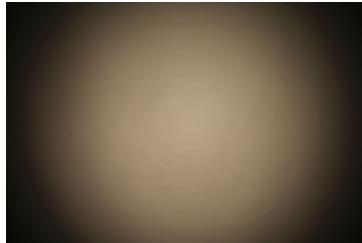

LUMILEDS

LED LUXEON CoB 1202/1203
 FWHM / FWTM 55.0° / 76.0°
 Efficiency 90 %
 Peak intensity 1 cd/lm
 LEDs/each optic 1
 Light colour White
 Required components:
 F17437_HEKLA-G2-H

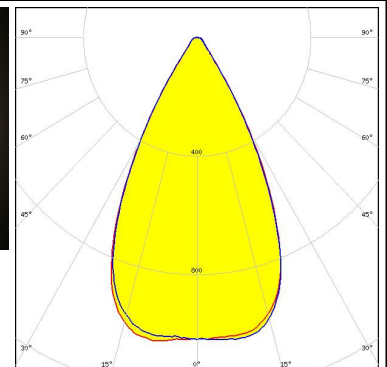
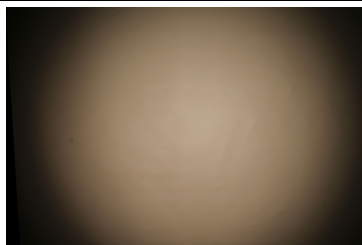

PHOTOMETRIC DATA (MEASURED):



LED COB L-Type (LES 11)
 FWHM / FWTM 54.0° / 77.0°
 Efficiency 90 %
 Peak intensity 1 cd/lm
 LEDs/each optic 1
 Light colour White
 Required components:
 F17437_HEKLA-G2-H

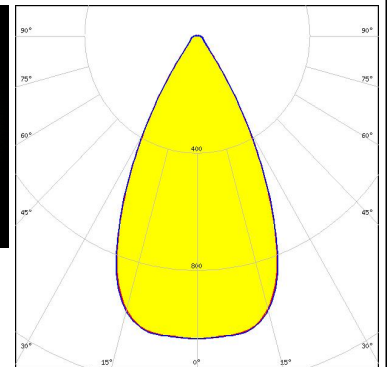
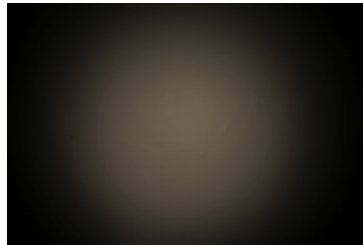

LED COB L-Type (LES 9)
 FWHM / FWTM 55.0° / 77.0°
 Efficiency 90 %
 Peak intensity 1 cd/lm
 LEDs/each optic 1
 Light colour White
 Required components:
 F17437_HEKLA-G2-H

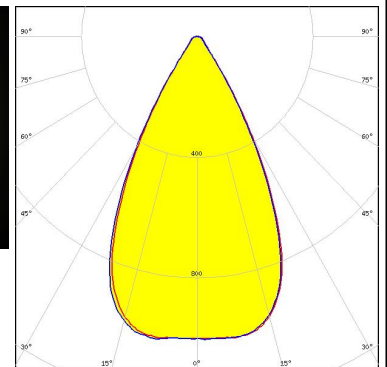
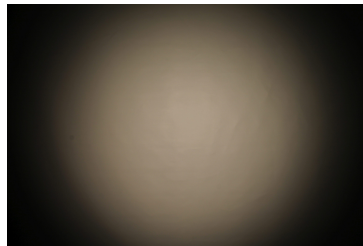

LED Fortimo SLM L09 CoB
 FWHM / FWTM 54.0° / 76.0°
 Efficiency 90 %
 Peak intensity 1 cd/lm
 LEDs/each optic 1
 Light colour White
 Required components:
 F17437_HEKLA-G2-H

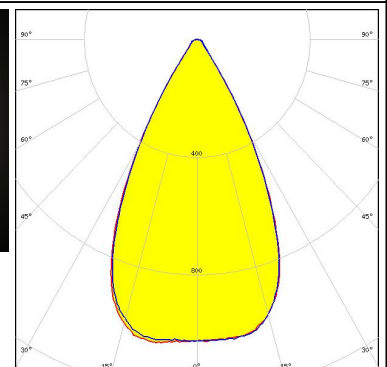
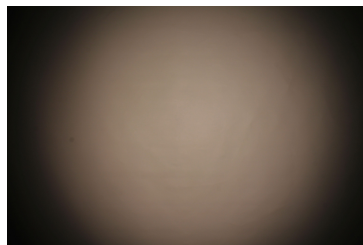

LED LC016D / LC019D / LC026D / LC033D
 FWHM / FWTM 52.0° / 79.0°
 Efficiency 89 %
 Peak intensity 1.1 cd/lm
 LEDs/each optic 1
 Light colour White
 Required components:
 F17438_HEKLA-G2-I

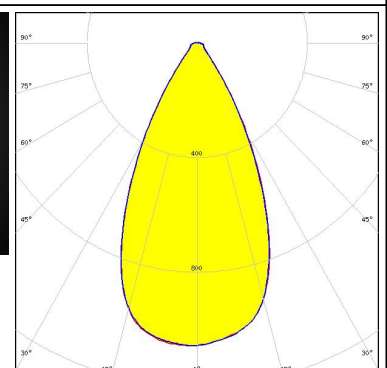
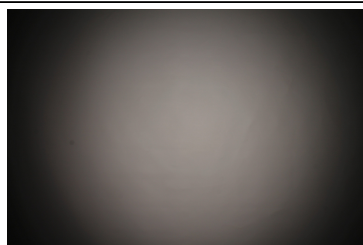

PHOTOMETRIC DATA (MEASURED):

SAMSUNG

LED LC030C/040C G2
 FWHM / FWTM 54.0° / 78.0°
 Efficiency 90 %
 Peak intensity 1 cd/m
 LEDs/each optic 1
 Light colour White
 Required components:
 F17438_HEKLA-G2-I

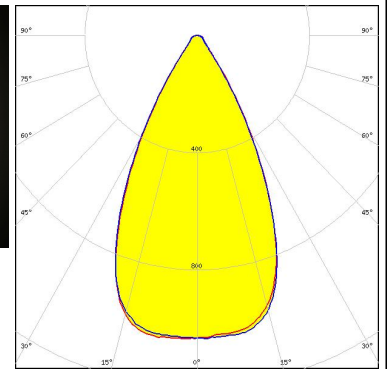
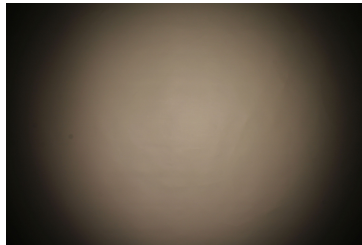

SEUL SEMICONDUCTOR
 LED MJT COB LES 14.5
 FWHM / FWTM 52.0° / 79.0°
 Efficiency 89 %
 Peak intensity 1.1 cd/m
 LEDs/each optic 1
 Light colour White
 Required components:
 F17438_HEKLA-G2-I

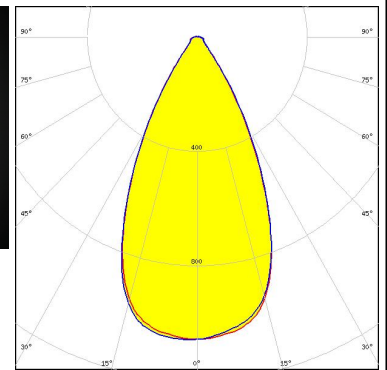
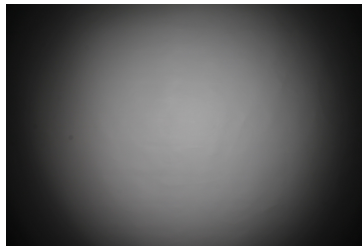

TRIDONIC

LED SLE G7 LES09
 FWHM / FWTM 55.0° / 76.0°
 Efficiency 90 %
 Peak intensity 1 cd/m
 LEDs/each optic 1
 Light colour White
 Required components:
 F17435_HEKLA-G2-C

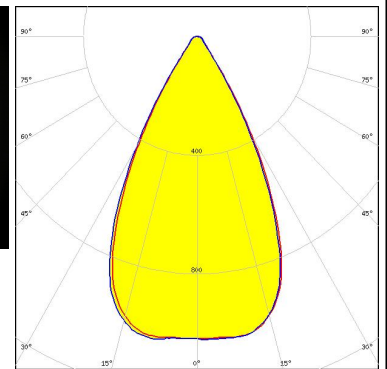
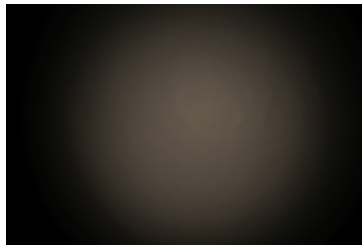

TRIDONIC

LED SLE G7 LES13
 FWHM / FWTM 53.0° / 78.0°
 Efficiency 90 %
 Peak intensity 1 cd/m
 LEDs/each optic 1
 Light colour White
 Required components:
 F17438_HEKLA-G2-I

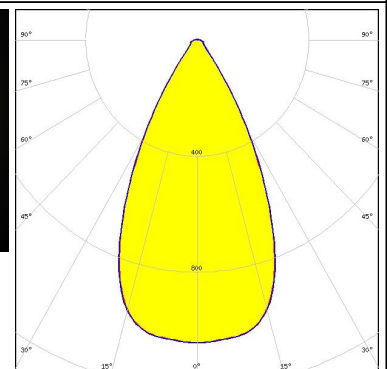
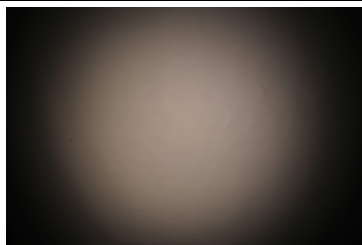

PHOTOMETRIC DATA (MEASURED):

TRIDONIC

LED SLE G7 LES15
FWHM / FWTM 52.0° / 78.0°
Efficiency 90 %
Peak intensity 1.1 cd/lm
LEDs/each optic 1
Light colour White
Required components:
F17438_HEKLA-G2-I

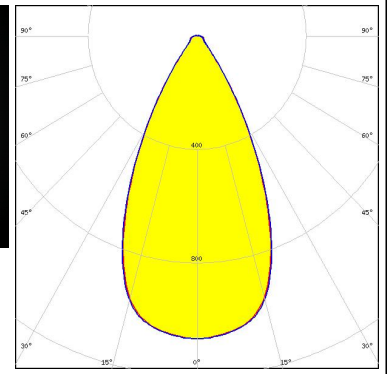

PHOTOMETRIC DATA (SIMULATED):

CITIZEN

LED CLL03x/CLU03x
FWHM / FWTM 54.0° / 80.0°
Efficiency 88 %
Peak intensity 1 cd/lm
LEDs/each optic 1
Light colour White
Required components:
F17438_HEKLA-G2-I

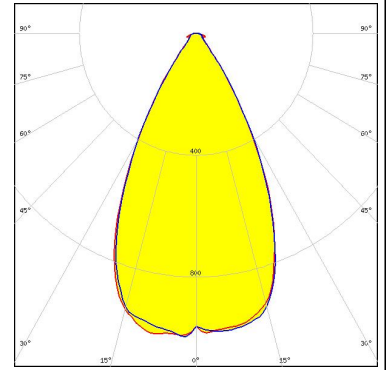

CITIZEN

LED CLU712
FWHM / FWTM 58.0° / 78.0°
Efficiency 90 %
Peak intensity 1 cd/lm
LEDs/each optic 1
Light colour White
Required components:
F17438_HEKLA-G2-I

