

YASMEEN-50-W

~36° wide beam. Assembly with holder C (LEDiL HEKLA) and B (BJB and B+W). Black and white versions.

SPECIFICATION:

Dimensions	Ø 49.9 mm
Height	27.7 mm
Fastening	socket
ROHS compliant	yes ⓘ



MATERIALS:

Component	Type	Material	Colour	Finish
YASMEEN-50-W	Single lens	PMMA	clear	
YASMEEN-50-HLD2-C	Holder C	PC	black	
YASMEEN-50-HLD2-B	Holder B	PC	black	
YASMEEN-50-HLD2-C-WHT	Holder C	PC	white	
YASMEEN-50-HLD2-B-WHT	Holder B	PC	white	

ORDERING INFORMATION:

Component	Qty in box	MOQ	MPQ	Box weight (kg)
C17236_YASMEEN-50-W	252	112	28	7.2
Assembly				
CP18746_YASMEEN-50-W-B2-WHT	252	112	28	8.7
CP18739_YASMEEN-50-W-C2-WHT	252	112	28	8.5
CP18732_YASMEEN-50-W-B2	252	112	28	8.7
CP18725_YASMEEN-50-W-C2	252	112	28	8.4

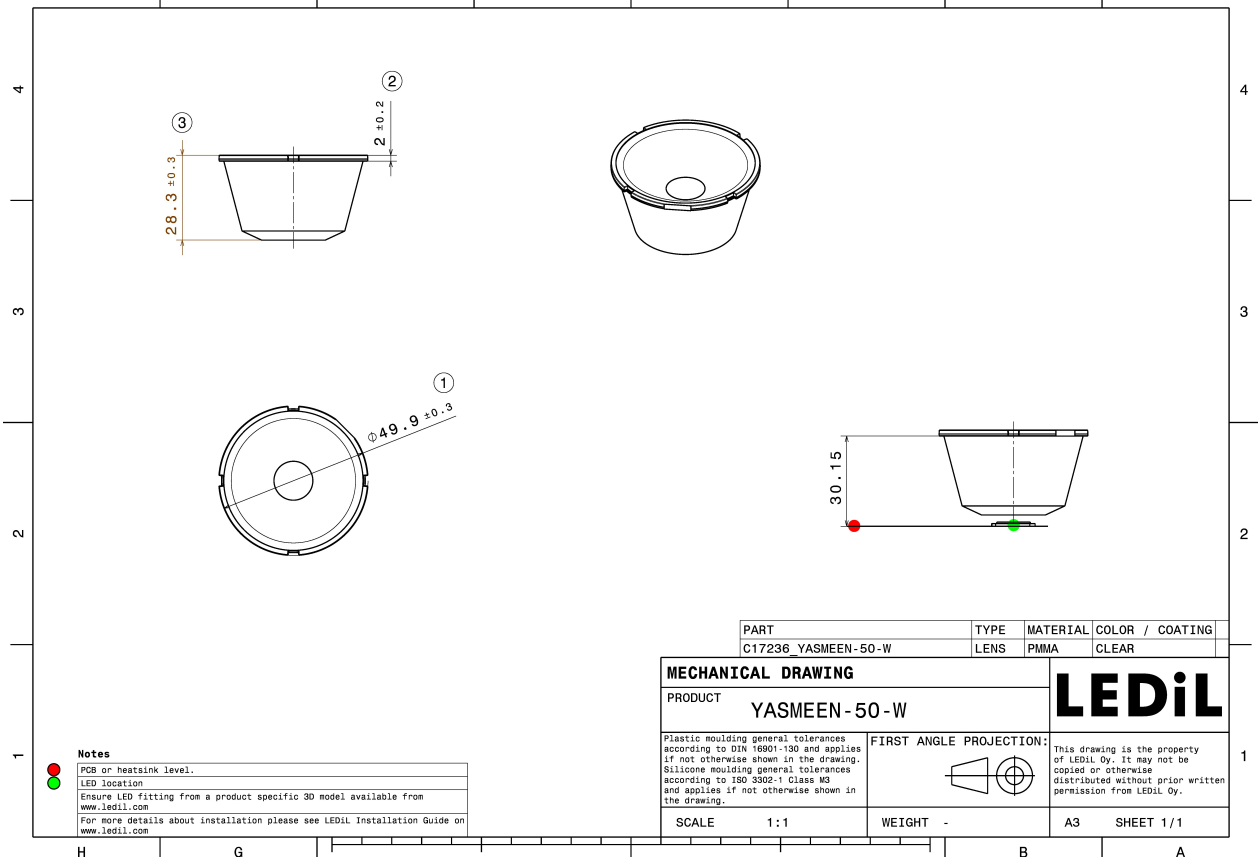
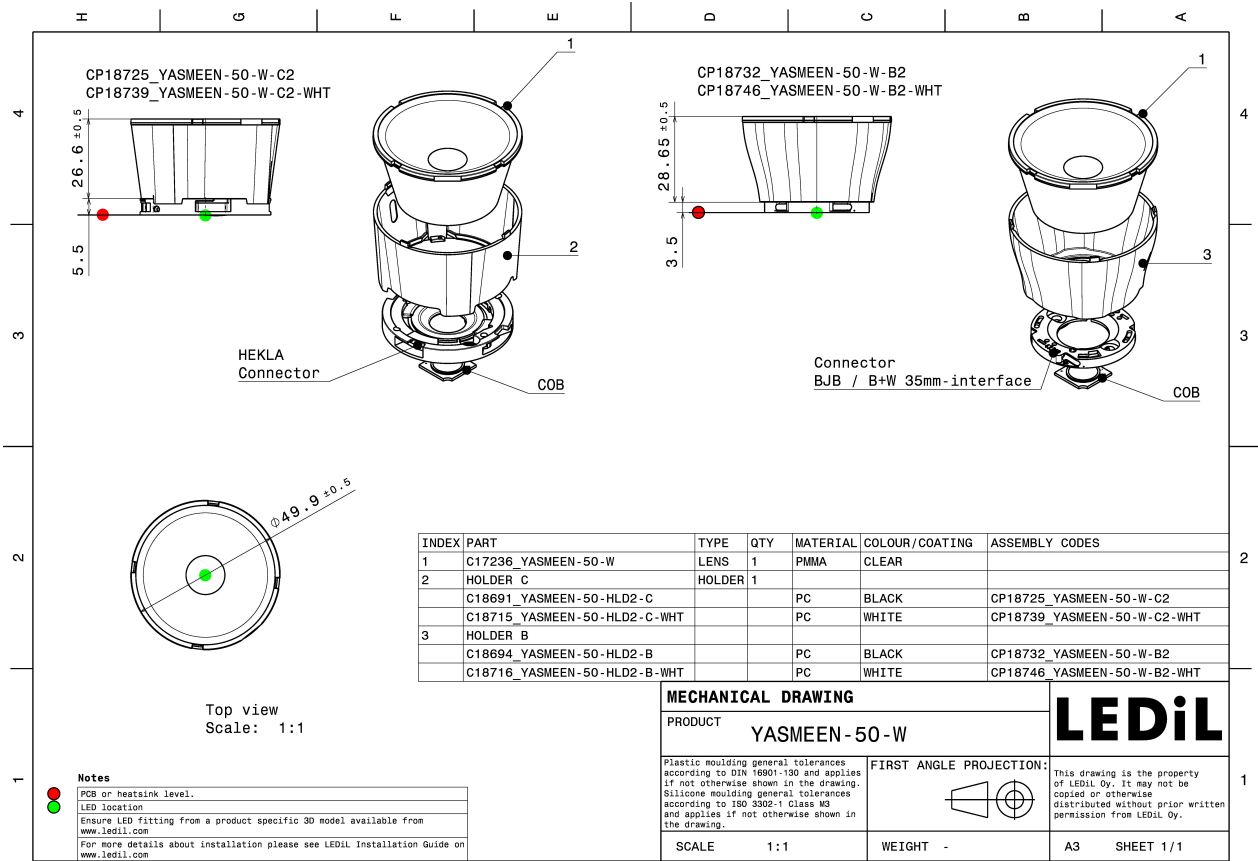

See also our general installation guide: www.ledil.com/installation_guide

OPTICAL RESULTS (MEASURED):

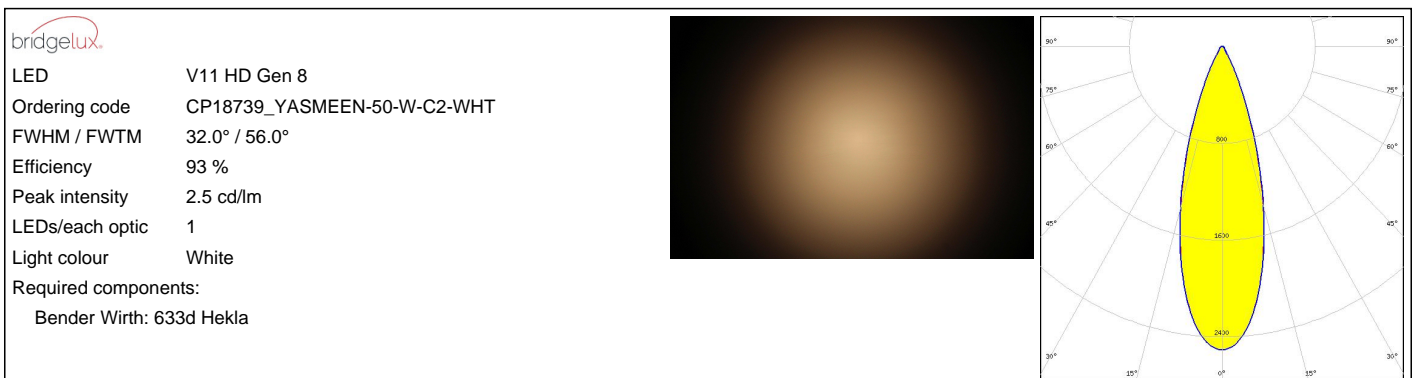

OPTICAL RESULTS (MEASURED):

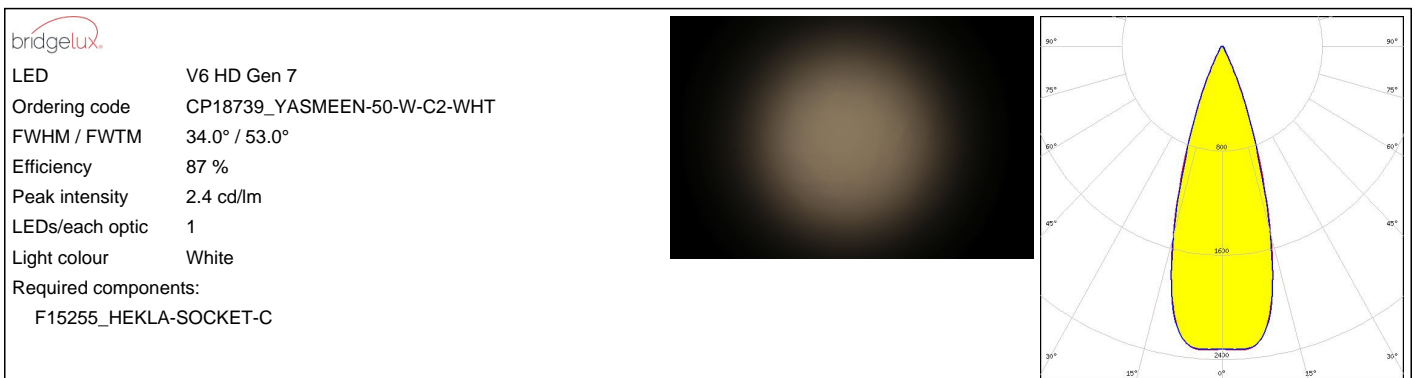
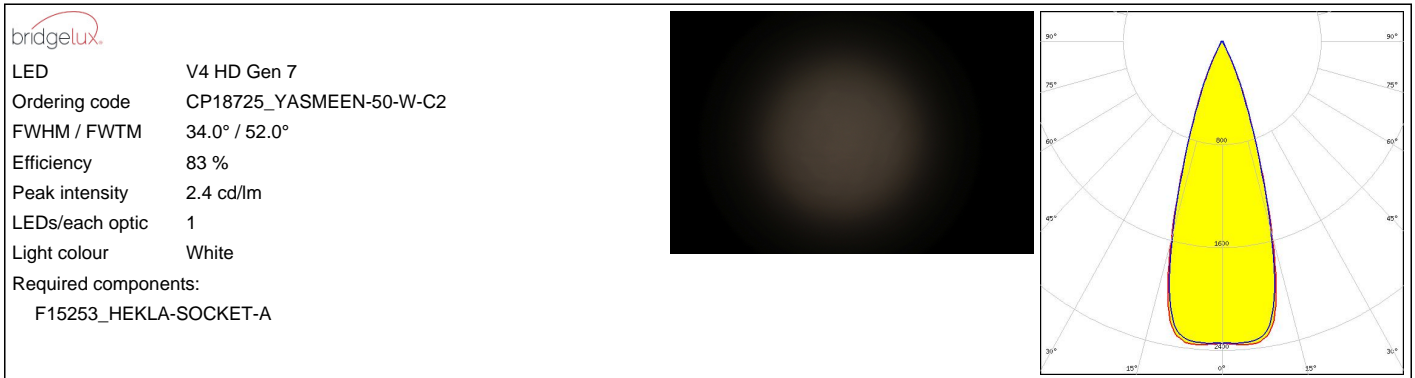
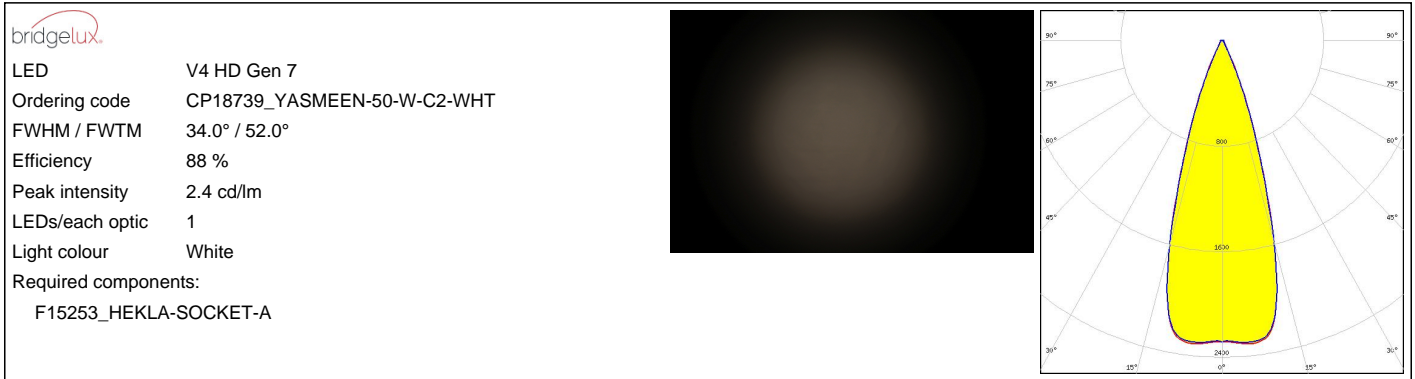

OPTICAL RESULTS (MEASURED):

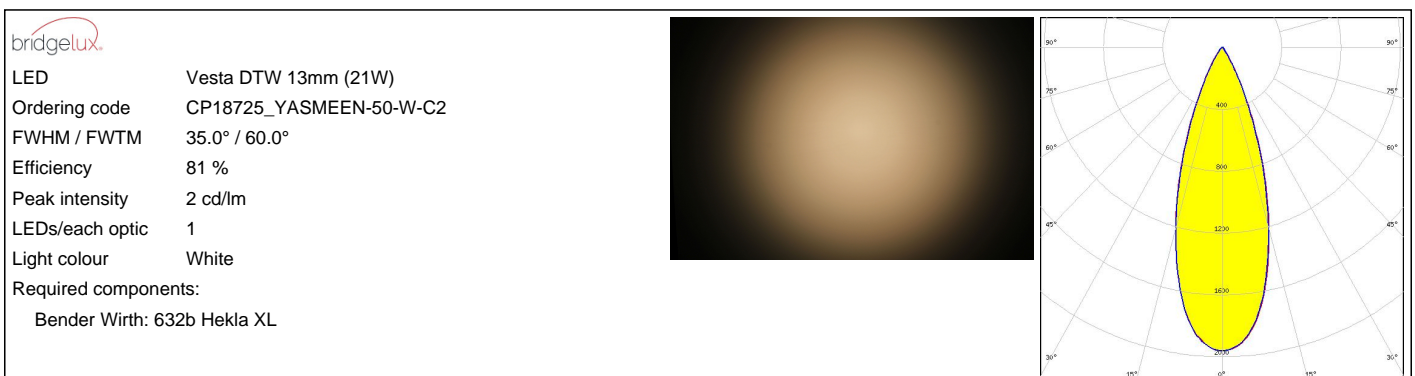

OPTICAL RESULTS (MEASURED):

			
LED	Vesta DTW 13mm (21W)		
Ordering code	CP18739_YASMEEN-50-W-C2-WHT		
FWHM / FWTM	36.0° / 62.0°		
Efficiency	90 %		
Peak intensity	2 cd/lm		
LEDs/each optic	1		
Light colour	White		
Required components:			
Bender Wirth: 632b Hekla XL			

			
LED	Vesta DTW 15mm (33W)		
Ordering code	CP18739_YASMEEN-50-W-C2-WHT		
FWHM / FWTM	38.0° / 65.0°		
Efficiency	89 %		
Peak intensity	1.7 cd/lm		
LEDs/each optic	1		
Light colour	White		
Required components:			
Bender Wirth: 632b Hekla XL			

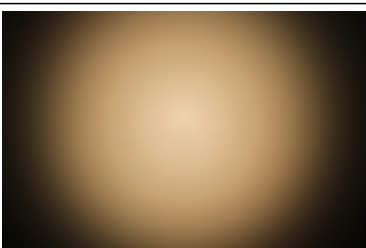
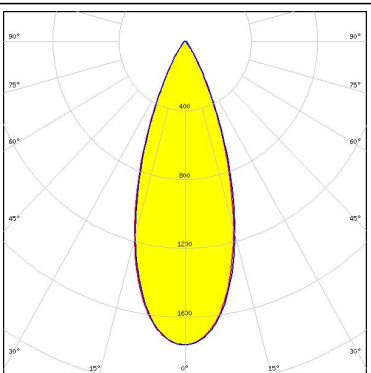
			
LED	Vesta DTW 15mm (33W)		
Ordering code	CP18725_YASMEEN-50-W-C2		
FWHM / FWTM	37.0° / 63.0°		
Efficiency	80 %		
Peak intensity	1.8 cd/lm		
LEDs/each optic	1		
Light colour	White		
Required components:			
Bender Wirth: 632b Hekla XL			

			
LED	Vesta DTW 9mm (4W/6W/12W)		
Ordering code	CP18725_YASMEEN-50-W-C2		
FWHM / FWTM	32.0° / 54.0°		
Efficiency	87 %		
Peak intensity	2.7 cd/lm		
LEDs/each optic	1		
Light colour	White		
Required components:			
Bender Wirth: 652b Hekla			

OPTICAL RESULTS (MEASURED):



LED Vesta DTW 9mm (4W/6W/12W)
Ordering code CP18739_YASMEEN-50-W-C2-WHT
FWHM / FWTM 32.0° / 55.0°
Efficiency 93 %
Peak intensity 2.6 cd/lm
LEDs/each optic 1
Light colour White
Required components:
 Bender Wirth: 652b Hekla

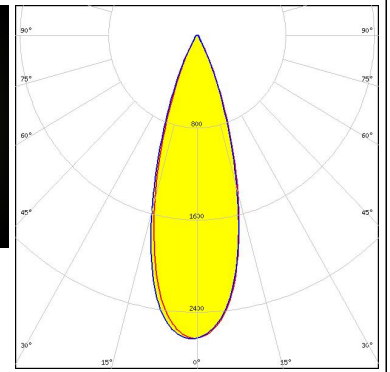
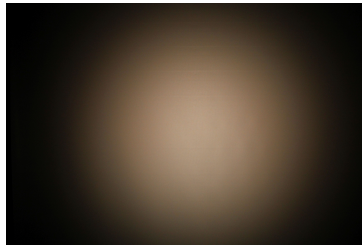

CITIZEN

LED CLL02x/CLU02x (LES10)
Ordering code CP18739_YASMEEN-50-W-C2-WHT
FWHM / FWTM 33.0° / 56.0°
Efficiency 86 %
Peak intensity 2.3 cd/lm
LEDs/each optic 1
Light colour White
Required components:
 F17435_HEKLA-G2-C

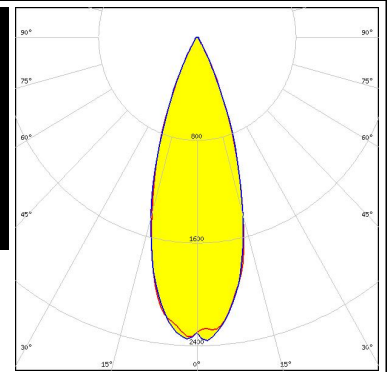

CITIZEN

LED CLL02x/CLU02x (LES10)
Ordering code CP18725_YASMEEN-50-W-C2
FWHM / FWTM 32.0° / 55.0°
Efficiency 80 %
Peak intensity 2.5 cd/lm
LEDs/each optic 1
Light colour White
Required components:
 F17435_HEKLA-G2-C

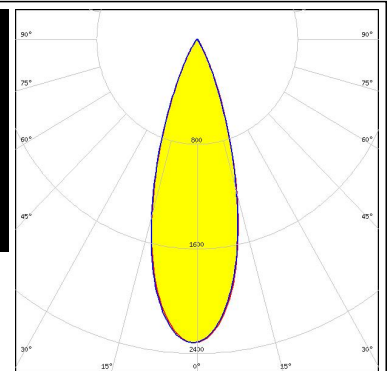

CITIZEN

LED CLU700/701/702/703
Ordering code CP18739_YASMEEN-50-W-C2-WHT
FWHM / FWTM 34.0° / 53.0°
Efficiency 87 %
Peak intensity 2.4 cd/lm
LEDs/each optic 1
Light colour White
Required components:
 F17435_HEKLA-G2-C

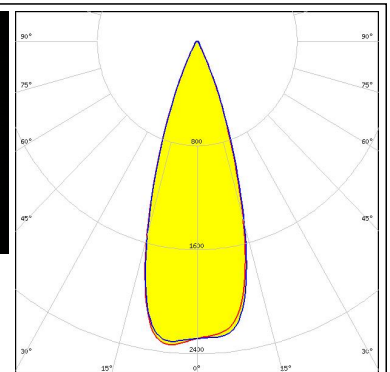
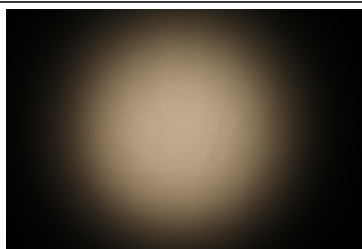

OPTICAL RESULTS (MEASURED):

CITIZEN

LED CLU700/701/702/703
Ordering code CP18725_YASMEEN-50-W-C2
FWHM / FWTM 34.0° / 53.0°
Efficiency 83 %
Peak intensity 2.4 cd/lm
LEDs/each optic 1
Light colour White
Required components:
F17435_HEKLA-G2-C

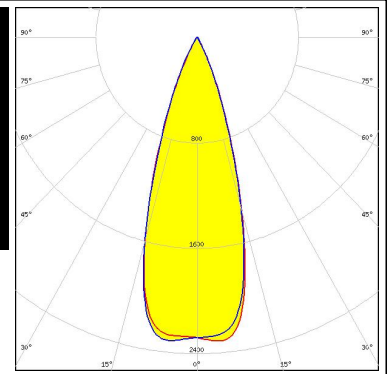
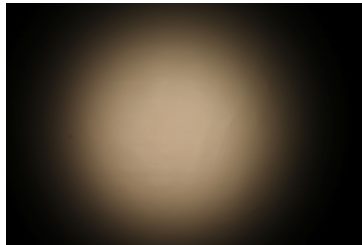

CITIZEN

LED CLU7A2/7A3
Ordering code CP18725_YASMEEN-50-W-C2
FWHM / FWTM 34.0° / 52.0°
Efficiency 83 %
Peak intensity 2.4 cd/lm
LEDs/each optic 1
Light colour White
Required components:
F17435_HEKLA-G2-C

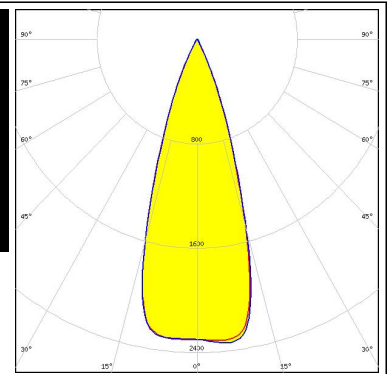
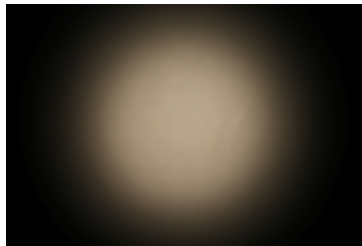

CITIZEN

LED CLU7A2/7A3
Ordering code CP18739_YASMEEN-50-W-C2-WHT
FWHM / FWTM 35.0° / 52.0°
Efficiency 88 %
Peak intensity 2.4 cd/lm
LEDs/each optic 1
Light colour White
Required components:
F17435_HEKLA-G2-C

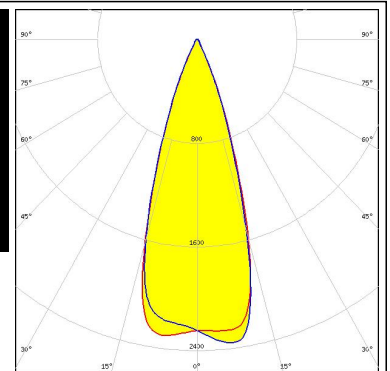
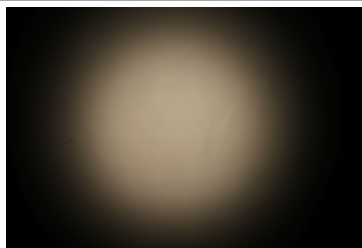

CITIZEN

LED CLU7B2
Ordering code CP18725_YASMEEN-50-W-C2
FWHM / FWTM 34.0° / 51.0°
Efficiency 83 %
Peak intensity 2.4 cd/lm
LEDs/each optic 1
Light colour White
Required components:
F17435_HEKLA-G2-C

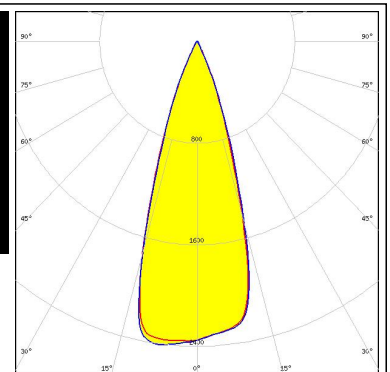
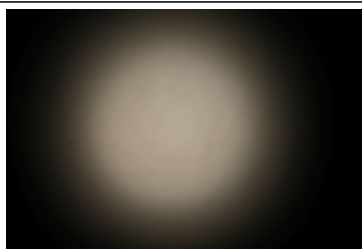

OPTICAL RESULTS (MEASURED):

CITIZEN

LED CLU7B2
Ordering code CP18739_YASMEEN-50-W-C2-WHT
FWHM / FWTM 34.0° / 51.0°
Efficiency 88 %
Peak intensity 2.4 cd/lm
LEDs/each optic 1
Light colour White
Required components:
F17435_HEKLA-G2-C

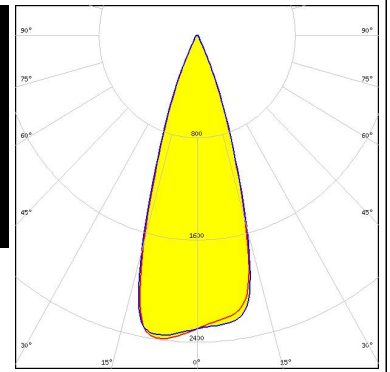

CREE LED

LED CMA1516
Ordering code CP18725_YASMEEN-50-W-C2
FWHM / FWTM 32.0° / 54.0°
Efficiency 81 %
Peak intensity 2.4 cd/lm
LEDs/each optic 1
Light colour White
Required components:
F17436_HEKLA-G2-D

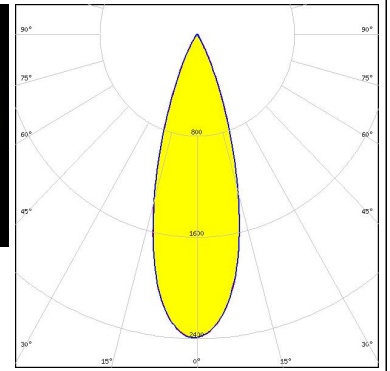

CREE LED

LED CMA1516
Ordering code CP18739_YASMEEN-50-W-C2-WHT
FWHM / FWTM 33.0° / 55.0°
Efficiency 87 %
Peak intensity 2.4 cd/lm
LEDs/each optic 1
Light colour White
Required components:
F17436_HEKLA-G2-D

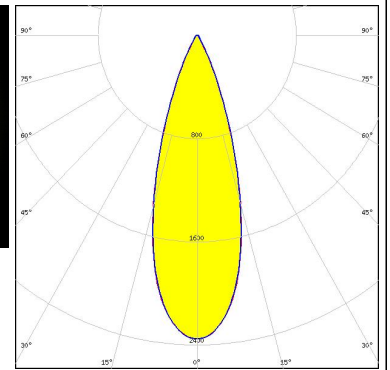

CREE LED

LED CMT14xx
Ordering code CP18725_YASMEEN-50-W-C2
FWHM / FWTM 32.0° / 55.0°
Efficiency 80 %
Peak intensity 2.4 cd/lm
LEDs/each optic 1
Light colour White
Required components:
F17435_HEKLA-G2-C

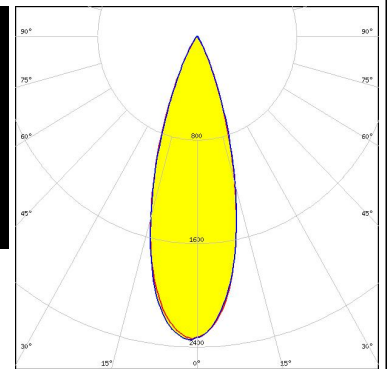
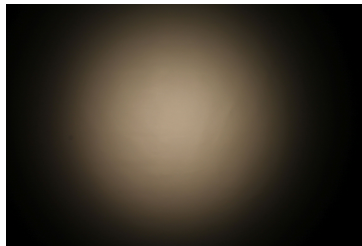

OPTICAL RESULTS (MEASURED):

CREE LED

LED CMT14xx
Ordering code CP18739_YASMEEN-50-W-C2-WHT
FWHM / FWTM 33.0° / 56.0°
Efficiency 86 %
Peak intensity 2.3 cd/lm
LEDs/each optic 1
Light colour White
Required components:
F17435_HEKLA-G2-C

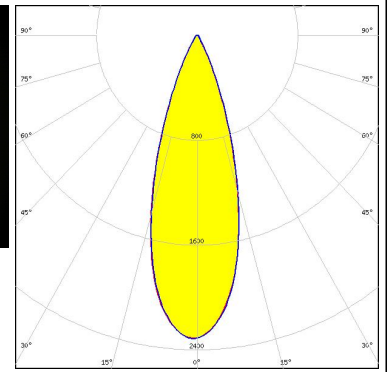
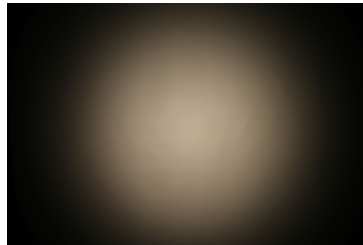

CREE LED

LED CMU10xx
Ordering code CP18725_YASMEEN-50-W-C2
FWHM / FWTM 32.0° / 54.0°
Efficiency 86 %
Peak intensity 2.6 cd/lm
LEDs/each optic 1
Light colour White
Required components:
F17435_HEKLA-G2-C

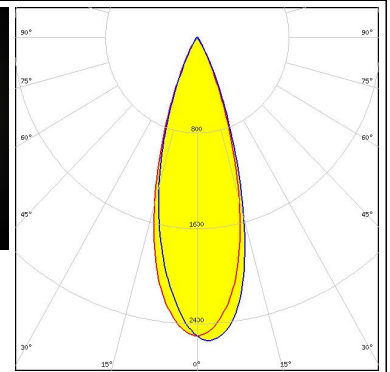
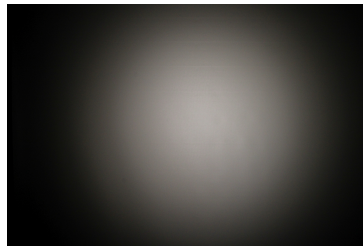

CREE LED

LED CXA/B 13xx
Ordering code CP18739_YASMEEN-50-W-C2-WHT
FWHM / FWTM 34.0° / 53.0°
Efficiency 89 %
Peak intensity 2.4 cd/lm
LEDs/each optic 1
Light colour White
Required components:
F17439_HEKLA-G2-J

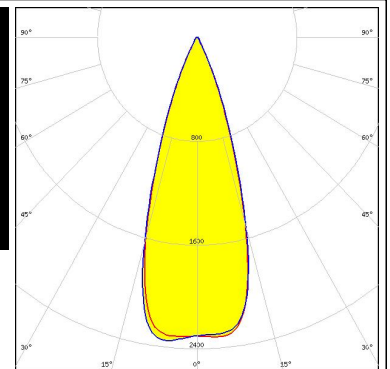
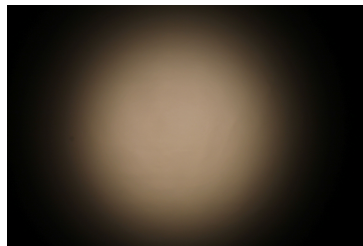

CREE LED

LED CXA/B 13xx
Ordering code CP18725_YASMEEN-50-W-C2
FWHM / FWTM 34.0° / 52.0°
Efficiency 84 %
Peak intensity 2.4 cd/lm
LEDs/each optic 1
Light colour White
Required components:
F17439_HEKLA-G2-J

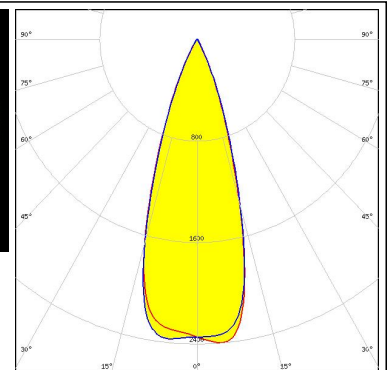
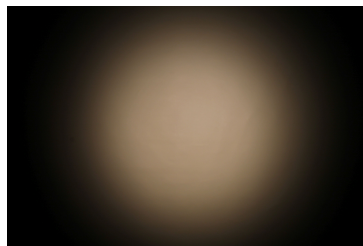

OPTICAL RESULTS (MEASURED):



LED CXA/B 15xx
Ordering code CP18725_YASMEEN-50-W-C2
FWHM / FWTM 33.0° / 54.0°
Efficiency 81 %
Peak intensity 2.4 cd/lm
LEDs/each optic 1
Light colour White
Required components:
 F17436_HEKLA-G2-D

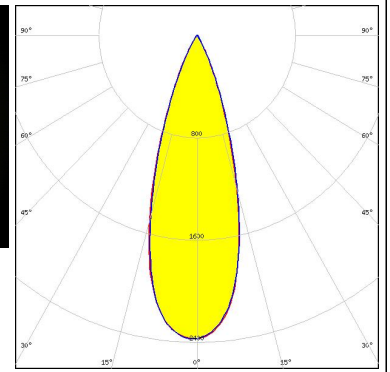
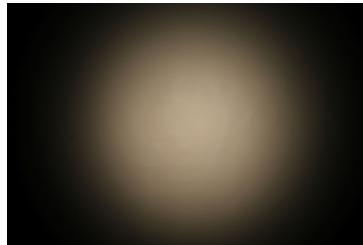

LED CXA/B 15xx
Ordering code CP18739_YASMEEN-50-W-C2-WHT
FWHM / FWTM 33.0° / 55.0°
Efficiency 87 %
Peak intensity 2.4 cd/lm
LEDs/each optic 1
Light colour White
Required components:
 F17436_HEKLA-G2-D

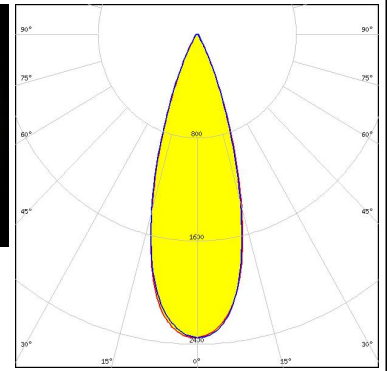

LED LEDiM/C6
Ordering code CP18725_YASMEEN-50-W-C2
FWHM / FWTM 33.0° / 54.0°
Efficiency 86 %
Peak intensity 2.5 cd/lm
LEDs/each optic 1
Light colour White
Required components:
 F17438_HEKLA-G2-I

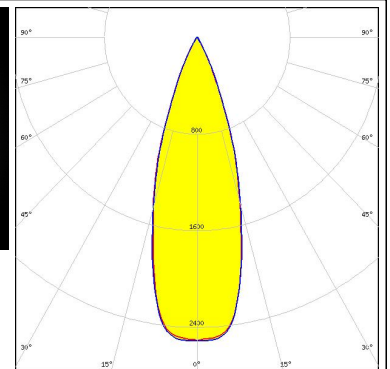
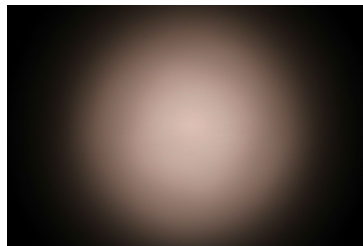

LED LUXEON CoB 1202/1203
Ordering code CP18725_YASMEEN-50-W-C2
FWHM / FWTM 32.0° / 54.0°
Efficiency 80 %
Peak intensity 2.4 cd/lm
LEDs/each optic 1
Light colour White
Required components:
 F17437_HEKLA-G2-H

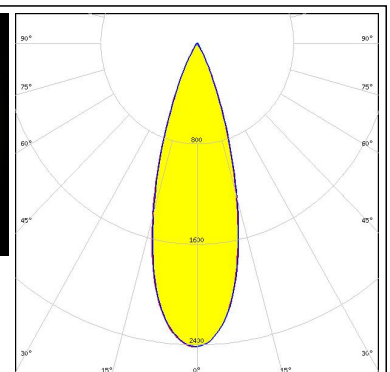
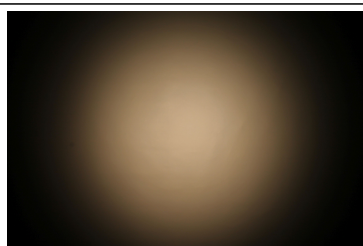

OPTICAL RESULTS (MEASURED):

LUMILEDS

LED LUXEON CoB 1202/1203
Ordering code CP18739_YASMEEN-50-W-C2-WHT
FWHM / FWTM 32.5° / 54.5°
Efficiency 86 %
Peak intensity 2.4 cd/lm
LEDs/each optic 1
Light colour White
Required components:
F17437_HEKLA-G2-H

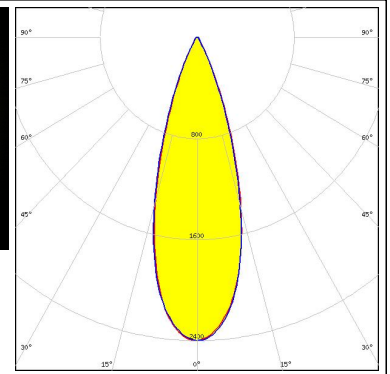
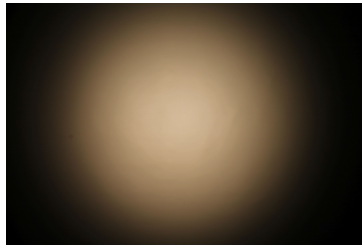

LUMILEDS

LED LUXEON CoB 1204HD
Ordering code CP18725_YASMEEN-50-W-C2
FWHM / FWTM 31.0° / 53.0°
Efficiency 80 %
Peak intensity 2.4 cd/lm
LEDs/each optic 1
Light colour White
Required components:
F17437_HEKLA-G2-H

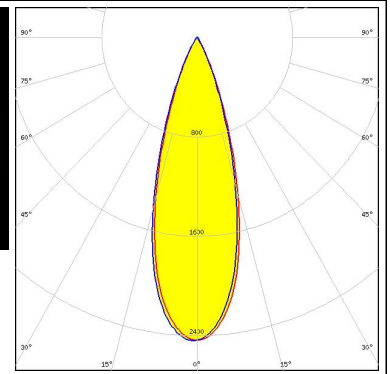

LUMILEDS

LED LUXEON CoB 1204HD
Ordering code CP18739_YASMEEN-50-W-C2-WHT
FWHM / FWTM 32.0° / 54.0°
Efficiency 87 %
Peak intensity 2.4 cd/lm
LEDs/each optic 1
Light colour White
Required components:
F17437_HEKLA-G2-H

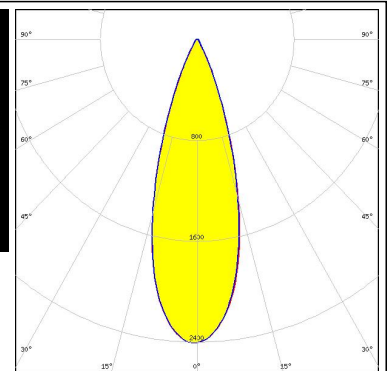
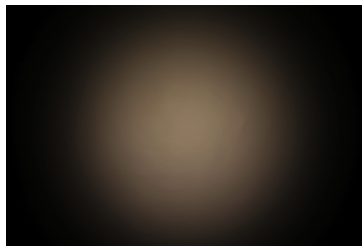

LUMILEDS

LED LUXEON CoB M02/M03
Ordering code CP18725_YASMEEN-50-W-C2
FWHM / FWTM 32.0° / 54.0°
Efficiency 81 %
Peak intensity 2.4 cd/lm
LEDs/each optic 1
Light colour White
Required components:
F17436_HEKLA-G2-D

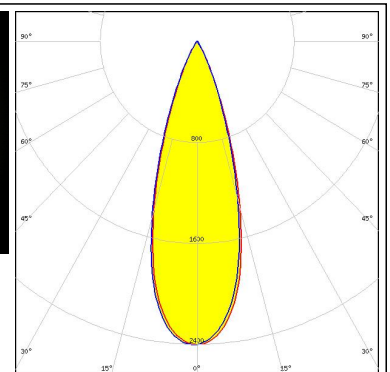
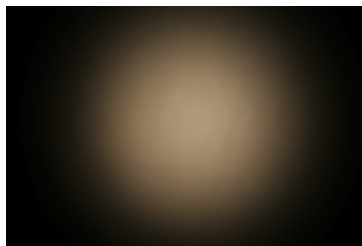

OPTICAL RESULTS (MEASURED):

LUMILEDS

LED LUXEON CoB M02/M03
 Ordering code CP18739_YASMEEN-50-W-C2-WHT
 FWHM / FWTM 33.0° / 54.0°
 Efficiency 87 %
 Peak intensity 2.4 cd/lm
 LEDs/each optic 1
 Light colour White
 Required components:
 F17436_HEKLA-G2-D

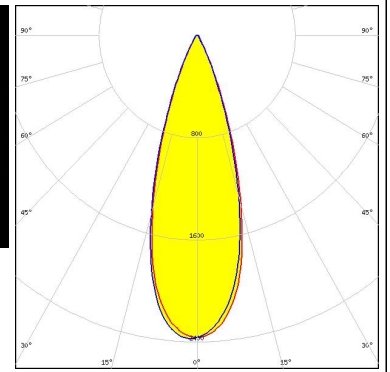

LUMILEDS

LED LUXEON CoB S01
 Ordering code CP18725_YASMEEN-50-W-C2
 FWHM / FWTM 34.0° / 52.0°
 Efficiency 83 %
 Peak intensity 2.4 cd/lm
 LEDs/each optic 1
 Light colour White
 Required components:
 F17439_HEKLA-G2-J

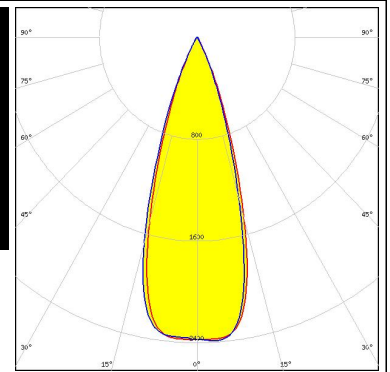

LUMILEDS

LED LUXEON CoB S01
 Ordering code CP18739_YASMEEN-50-W-C2-WHT
 FWHM / FWTM 34.0° / 52.0°
 Efficiency 88 %
 Peak intensity 2.4 cd/lm
 LEDs/each optic 1
 Light colour White
 Required components:
 F17439_HEKLA-G2-J

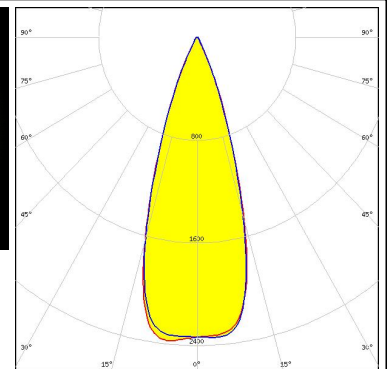

LUMINUS

LED CXM-3
 Ordering code CP18725_YASMEEN-50-W-C2
 FWHM / FWTM 33.0° / 51.0°
 Efficiency 83 %
 Peak intensity 2.4 cd/lm
 LEDs/each optic 1
 Light colour White
 Required components:
 F17435_HEKLA-G2-C

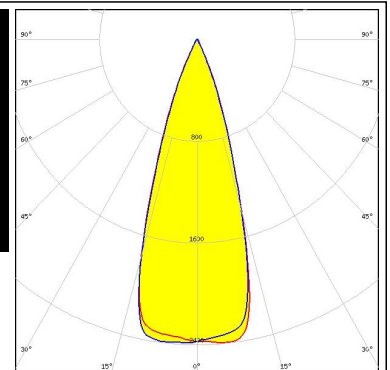
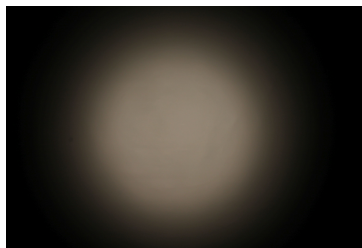

OPTICAL RESULTS (MEASURED):



LED CXM-3
Ordering code CP18739_YASMEEN-50-W-C2-WHT
FWHM / FWTM 34.0° / 50.0°
Efficiency 87 %
Peak intensity 2.4 cd/lm
LEDs/each optic 1
Light colour White
Required components:
 F17435_HEKLA-G2-C

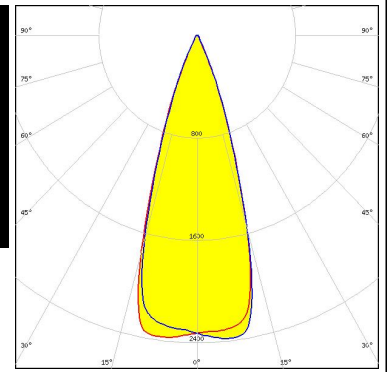

LED CXM-4
Ordering code CP18739_YASMEEN-50-W-C2-WHT
FWHM / FWTM 34.0° / 51.0°
Efficiency 88 %
Peak intensity 2.4 cd/lm
LEDs/each optic 1
Light colour White
Required components:
 F17435_HEKLA-G2-C

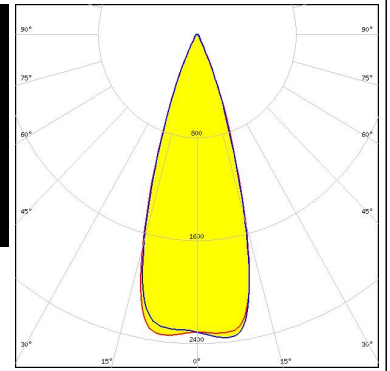

LED CXM-4
Ordering code CP18725_YASMEEN-50-W-C2
FWHM / FWTM 33.0° / 51.0°
Efficiency 83 %
Peak intensity 2.4 cd/lm
LEDs/each optic 1
Light colour White
Required components:
 F17435_HEKLA-G2-C

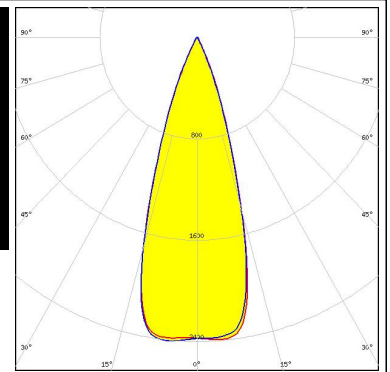

LED COB L-Type (LES 9)
Ordering code CP18739_YASMEEN-50-W-C2-WHT
FWHM / FWTM 33.0° / 54.0°
Efficiency 86 %
Peak intensity 2.3 cd/lm
LEDs/each optic 1
Light colour White
Required components:
 F17437_HEKLA-G2-H

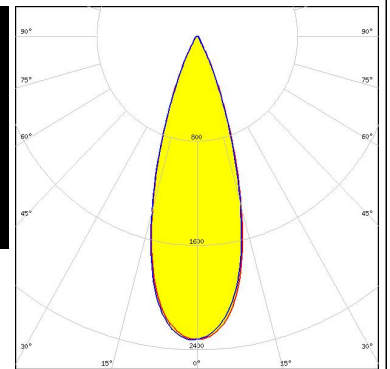
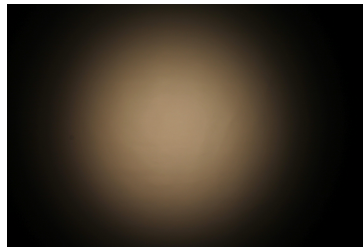

OPTICAL RESULTS (MEASURED):



LED COB S-Type (LES 7)
Ordering code CP18739_YASMEEN-50-W-C2-WHT
FWHM / FWTM 34.0° / 54.0°
Efficiency 87 %
Peak intensity 2.3 cd/lm
LEDs/each optic 1
Light colour White
Required components:
 F15848_HEKLA-SOCKET-G

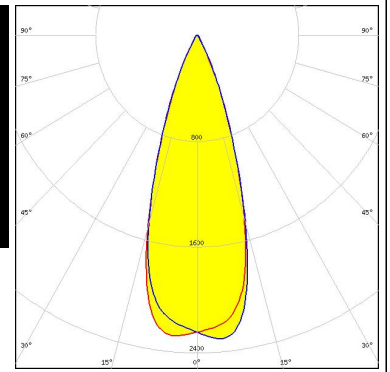
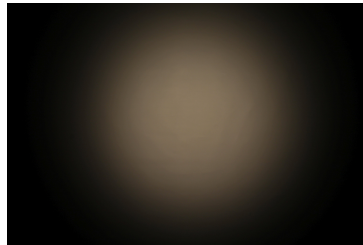

LED Fortimo SLM L09 CoB
Ordering code CP18739_YASMEEN-50-W-C2-WHT
FWHM / FWTM 32.0° / 54.0°
Efficiency 86 %
Peak intensity 2.4 cd/lm
LEDs/each optic 1
Light colour White
Required components:
 F17437_HEKLA-G2-H

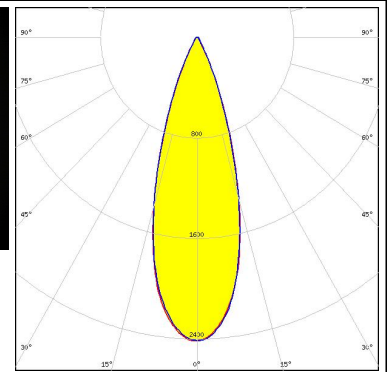
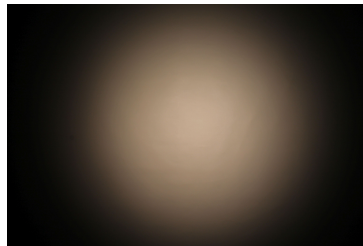

LED Fortimo SLM L09 CoB
Ordering code CP18725_YASMEEN-50-W-C2
FWHM / FWTM 32.0° / 53.0°
Efficiency 80 %
Peak intensity 2.4 cd/lm
LEDs/each optic 1
Light colour White
Required components:
 F17437_HEKLA-G2-H

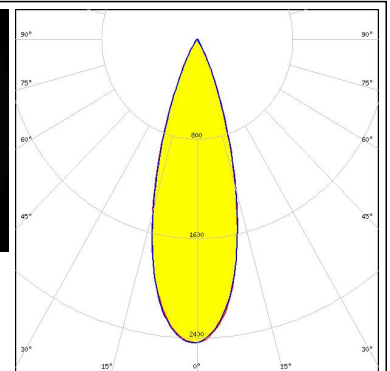
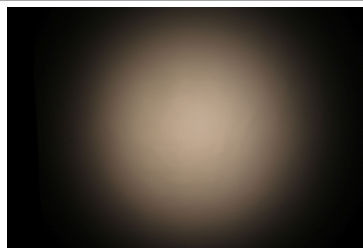

LED LC003D / LC006D / LC009D / LC013D
Ordering code CP18725_YASMEEN-50-W-C2
FWHM / FWTM 32.0° / 55.0°
Efficiency 80 %
Peak intensity 2.3 cd/lm
LEDs/each optic 1
Light colour White
Required components:
 F17435_HEKLA-G2-C

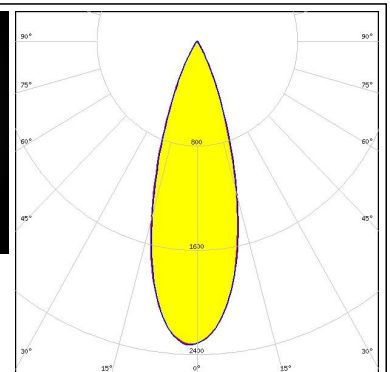
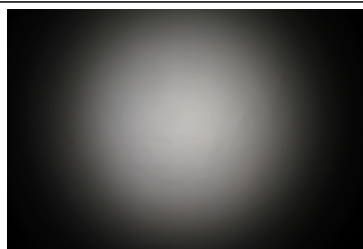

OPTICAL RESULTS (MEASURED):

SAMSUNG

LED LC003D / LC006D / LC009D / LC013D
 Ordering code CP18739_YASMEEN-50-W-C2-WHT
 FWHM / FWTM 33.0° / 56.0°
 Efficiency 86 %
 Peak intensity 2.3 cd/lm
 LEDs/each optic 1
 Light colour White
 Required components:
 F17435_HEKLA-G2-C

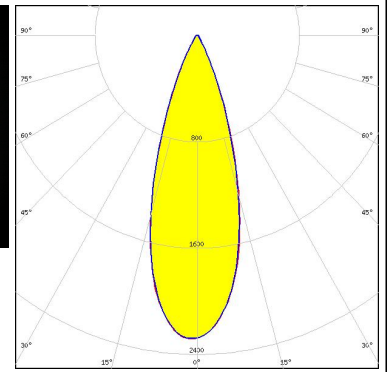

SEOUL SEMICONDUCTOR
 LED MJT COB LES 6
 Ordering code CP18725_YASMEEN-50-W-C2
 FWHM / FWTM 34.0° / 53.0°
 Efficiency 83 %
 Peak intensity 2.3 cd/lm
 LEDs/each optic 1
 Light colour White
 Required components:
 F17435_HEKLA-G2-C

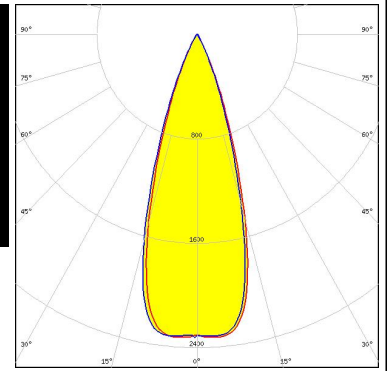

SEOUL SEMICONDUCTOR
 LED MJT COB LES 6
 Ordering code CP18739_YASMEEN-50-W-C2-WHT
 FWHM / FWTM 35.0° / 54.0°
 Efficiency 88 %
 Peak intensity 2.3 cd/lm
 LEDs/each optic 1
 Light colour White
 Required components:
 F17435_HEKLA-G2-C

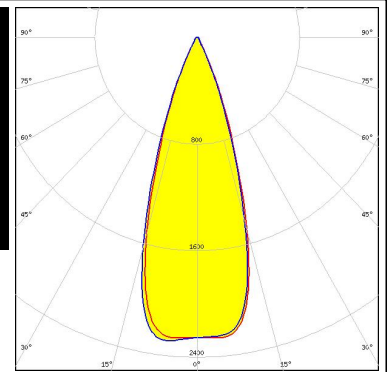

SEOUL SEMICONDUCTOR
 LED MJT COB LES 9.8
 Ordering code CP18725_YASMEEN-50-W-C2
 FWHM / FWTM 32.0° / 55.0°
 Efficiency 80 %
 Peak intensity 2.4 cd/lm
 LEDs/each optic 1
 Light colour White
 Required components:
 F17435_HEKLA-G2-C

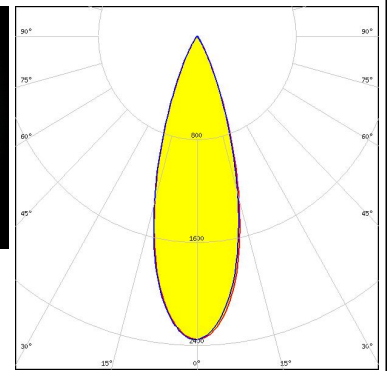

OPTICAL RESULTS (MEASURED):



OPTICAL RESULTS (SIMULATED):



LED V6 HD Gen 7
Ordering code CP18725_YASMEEN-50-W-C2
FWHM / FWTM 38.0° / 54.0°
Efficiency 90 %
Peak intensity 2.3 cd/lm
LEDs/each optic 1
Light colour White
Required components:
 F17435_HEKLA-G2-C

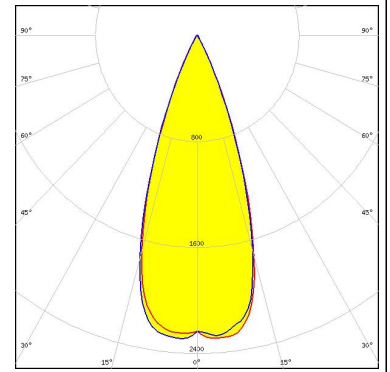

LED Vero SE 13
Ordering code CP18725_YASMEEN-50-W-C2
FWHM / FWTM 30.0° / 52.0°
Efficiency 74 %
Peak intensity 2.4 cd/lm
LEDs/each optic 1
Light colour White
Required components:
 C16142_HEKLA-SOCKET-K

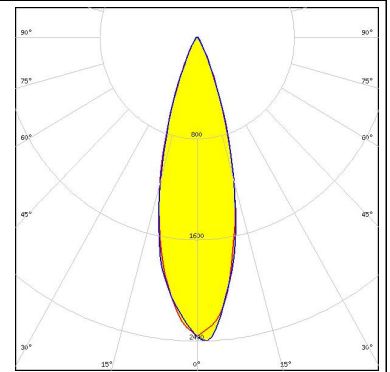

CITIZEN

LED CLL02x/CLU02x (LES10)
Ordering code CP18732_YASMEEN-50-W-B2
FWHM / FWTM 36.0° / 56.0°
Efficiency 86 %
Peak intensity 2.3 cd/lm
LEDs/each optic 1
Light colour White
Required components:
 BJB: 47.360.1020

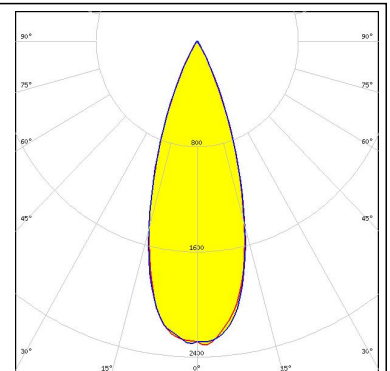

CITIZEN

LED CLL02x/CLU02x (LES10)
Ordering code CP18746_YASMEEN-50-W-B2-WHT
FWHM / FWTM 36.0° / 56.0°
Efficiency 93 %
Peak intensity 2.4 cd/lm
LEDs/each optic 1
Light colour White
Required components:
 BJB: 47.360.1020

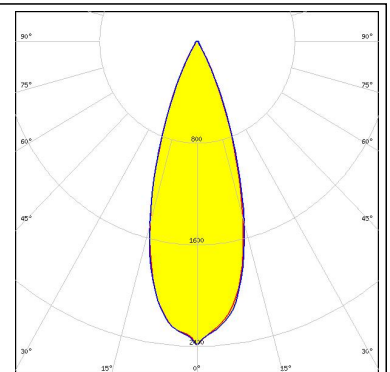

OPTICAL RESULTS (SIMULATED):

CITIZEN

LED CLU712/713
Ordering code CP18725_YASMEEN-50-W-C2
FWHM / FWTM 36.0° / 56.0°
Efficiency 88 %
Peak intensity 2.4 cd/lm
LEDs/each optic 1
Light colour White
Required components:
F17438_HEKLA-G2-I

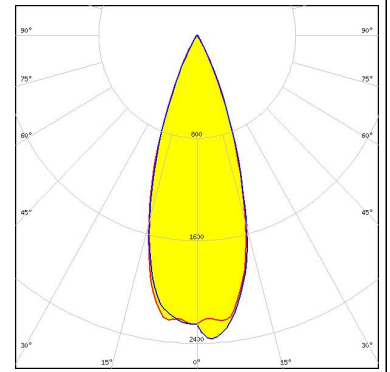

CREE LED

LED CHA0304
Ordering code CP18725_YASMEEN-50-W-C2
FWHM / FWTM 38.0° / 52.0°
Efficiency 90 %
Peak intensity 2.5 cd/lm
LEDs/each optic 1
Light colour White
Required components:
F17435_HEKLA-G2-C

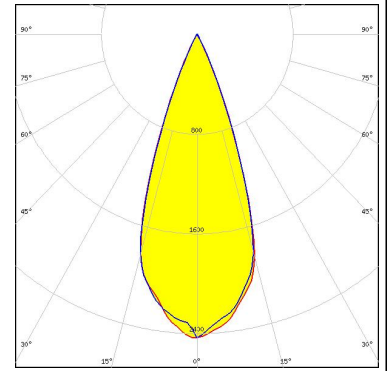

CREE LED

LED CHA0410
Ordering code CP18725_YASMEEN-50-W-C2
FWHM / FWTM 38.0° / 54.0°
Efficiency 90 %
Peak intensity 2.4 cd/lm
LEDs/each optic 1
Light colour White
Required components:
F17435_HEKLA-G2-C

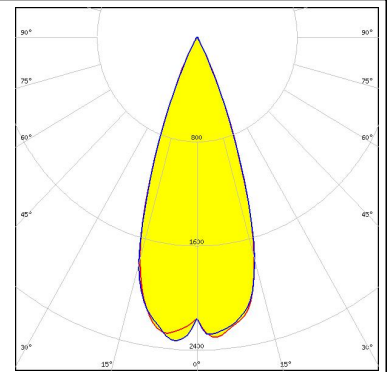

CREE LED

LED CHA0612
Ordering code CP18725_YASMEEN-50-W-C2
FWHM / FWTM 38.0° / 54.0°
Efficiency 90 %
Peak intensity 2.3 cd/lm
LEDs/each optic 1
Light colour White
Required components:
F17435_HEKLA-G2-C

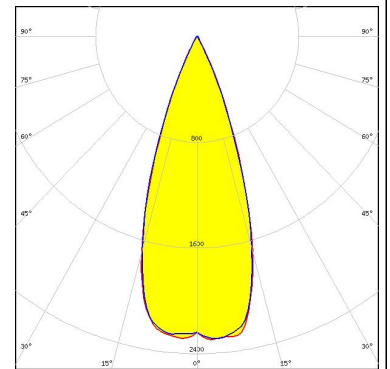

OPTICAL RESULTS (SIMULATED):

PHILIPS

LED Fortimo SLM L15 CoB
Ordering code CP18725_YASMEEN-50-W-C2
FWHM / FWTM 37.0° / 62.0°
Efficiency 81 %
Peak intensity 1.9 cd/lm
LEDs/each optic 1
Light colour White
Required components:
Bender Wirth: 632a Hekla XL

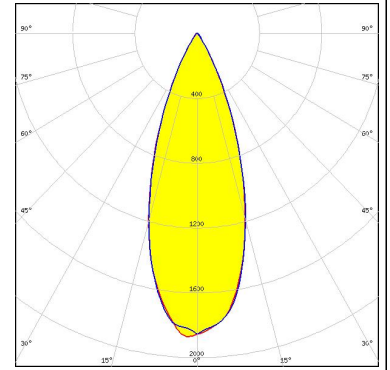

PHILIPS

LED Fortimo SLM L15 CoB
Ordering code CP18725_YASMEEN-50-W-C2
FWHM / FWTM 38.0° / 64.0°
Efficiency 79 %
Peak intensity 1.8 cd/lm
LEDs/each optic 1
Light colour White
Required components:
Bender Wirth: 632a Hekla XL

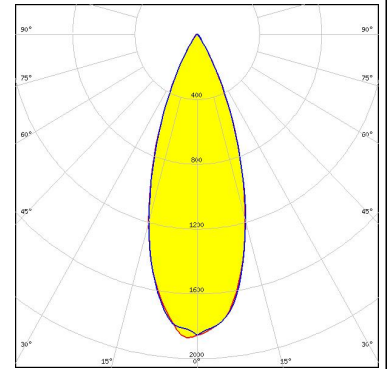

TRIDONIC

LED SLE G7 LES13
Ordering code CP18725_YASMEEN-50-W-C2
FWHM / FWTM 36.0° / 60.0°
Efficiency 83 %
Peak intensity 2.1 cd/lm
LEDs/each optic 1
Light colour White
Required components:
F17438_HEKLA-G2-I

