

YASMEEN-70-S

~15° spot beam. Assembly with holder C (LEDiL HEKLA) and B (BJB and B+W). Black and white versions.

SPECIFICATION:

Dimensions	Ø 70.0 mm
Height	37.7 mm
Fastening	socket
ROHS compliant	yes ⓘ



MATERIALS:

Component	Type	Material	Colour	Finish
YASMEEN-70-S	Single lens	PMMA	clear	
YASMEEN-70-HLD2-C	Holder C	PC	black	
YASMEEN-70-HLD2-B	Holder B	PC	black	
YASMEEN-70-HLD2-C-WHT	Holder C	PC	white	
YASMEEN-70-HLD2-B-WHT	Holder B	PC	white	

ORDERING INFORMATION:

Component	Qty in box	MOQ	MPQ	Box weight (kg)
C17238_YASMEEN-70-S	105	105	15	8.0
Assembly				
CP18782_YASMEEN-70-S-B2-WHT	105	105	15	9.5
CP18775_YASMEEN-70-S-C2-WHT	105	105	15	9.4
CP18768_YASMEEN-70-S-B2	105	105	15	9.5
CP18751_YASMEEN-70-S-C2	105	105	15	9.4

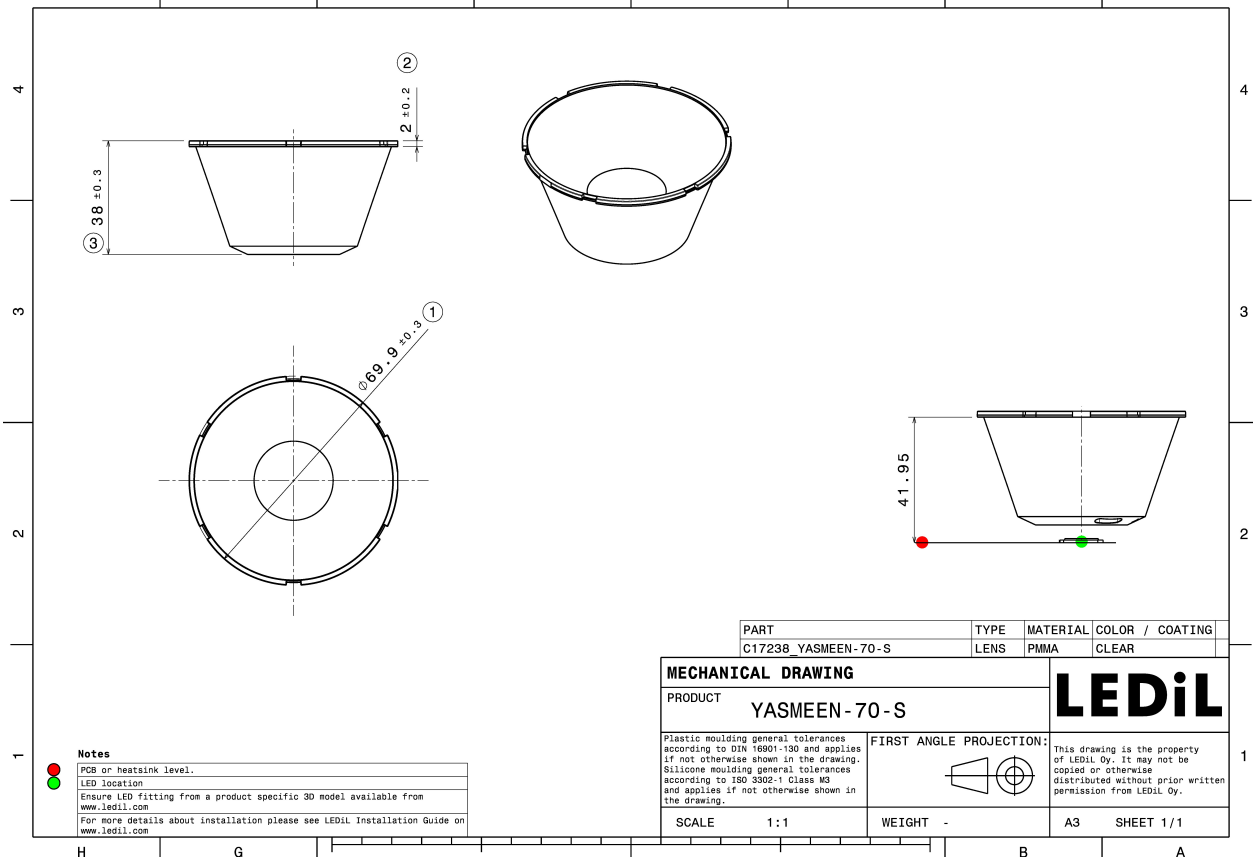
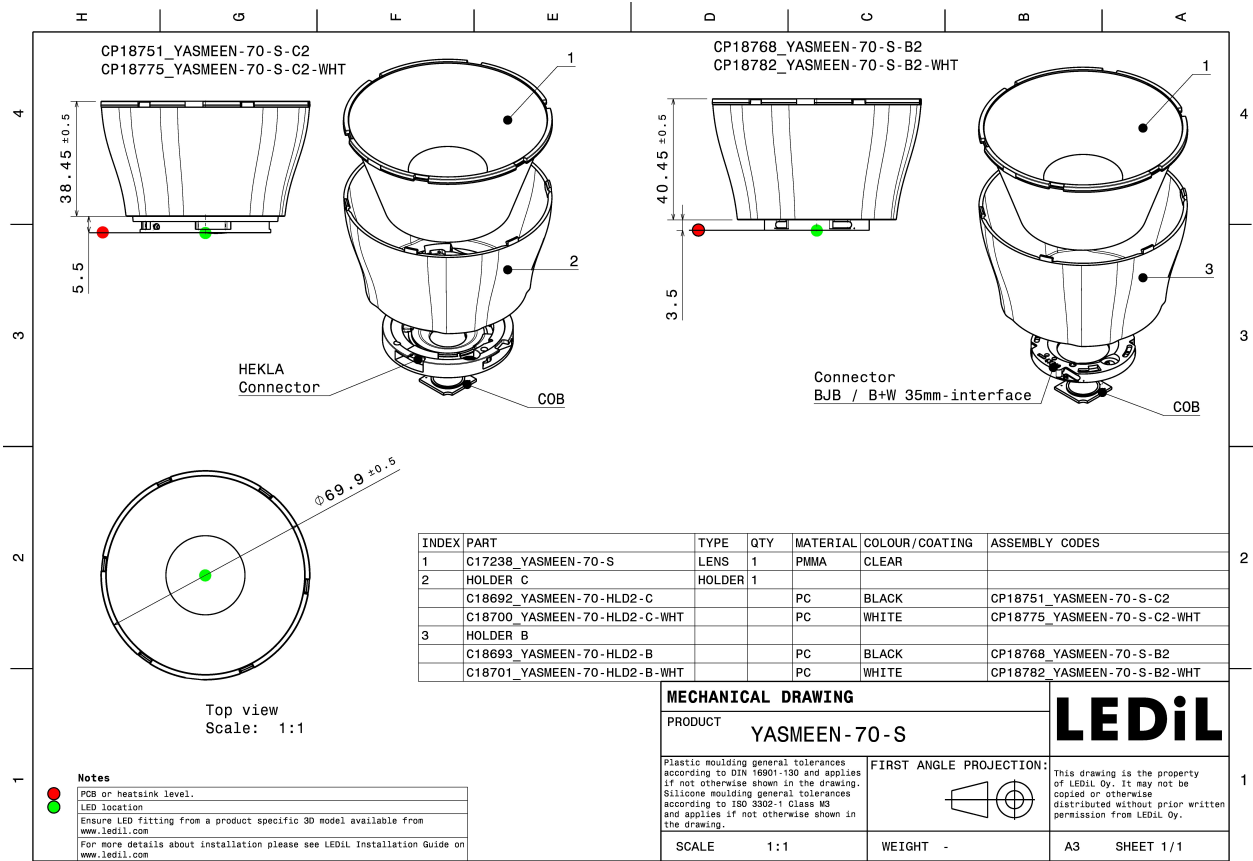

See also our general installation guide: www.ledil.com/installation_guide

OPTICAL RESULTS (MEASURED):

bridgelux

LED V10 Gen 8
 Ordering code CP18751_YASMEEN-70-S-C2
 FWHM / FWTM 16.0° / 27.0°
 Efficiency 88 %
 Peak intensity 9.5 cd/lm
 LEDs/each optic 1
 Light colour White
 Required components:
 F15255_HEKLA-SOCKET-C

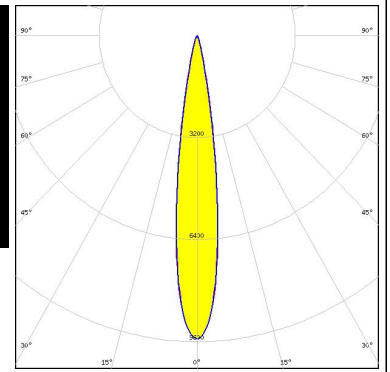

bridgelux

LED V11 HD Gen 8
 Ordering code CP18751_YASMEEN-70-S-C2
 FWHM / FWTM 18.0° / 30.0°
 Efficiency 87 %
 Peak intensity 8 cd/lm
 LEDs/each optic 1
 Light colour White
 Required components:
 Bender Wirth: 633d Hekla

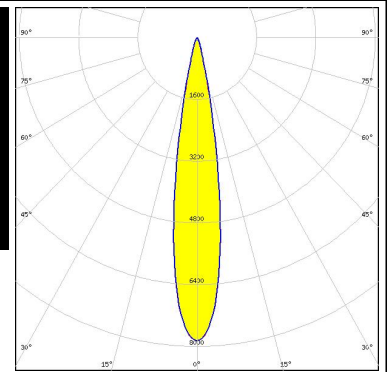

bridgelux

LED V11 HD Gen 8
 Ordering code CP18775_YASMEEN-70-S-C2-WHT
 FWHM / FWTM 18.0° / 30.0°
 Efficiency 93 %
 Peak intensity 8 cd/lm
 LEDs/each optic 1
 Light colour White
 Required components:
 Bender Wirth: 633d Hekla

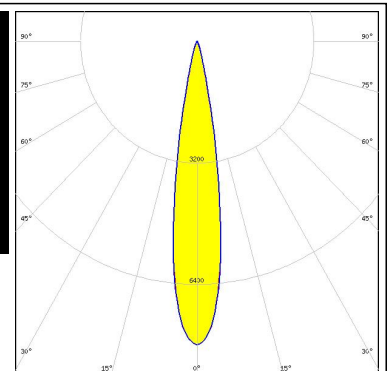
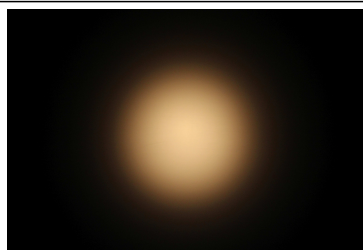

bridgelux

LED V13 Gen 8
 Ordering code CP18751_YASMEEN-70-S-C2
 FWHM / FWTM 23.0° / 39.0°
 Efficiency 86 %
 Peak intensity 4.8 cd/lm
 LEDs/each optic 1
 Light colour White
 Required components:
 F15859_HEKLA-SOCKET-I

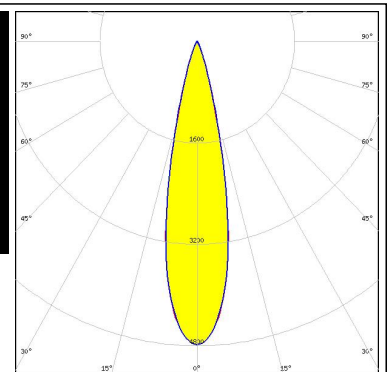
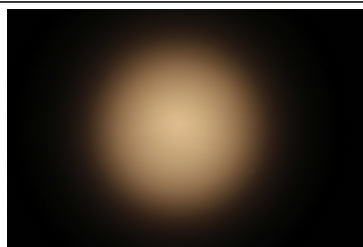

OPTICAL RESULTS (MEASURED):

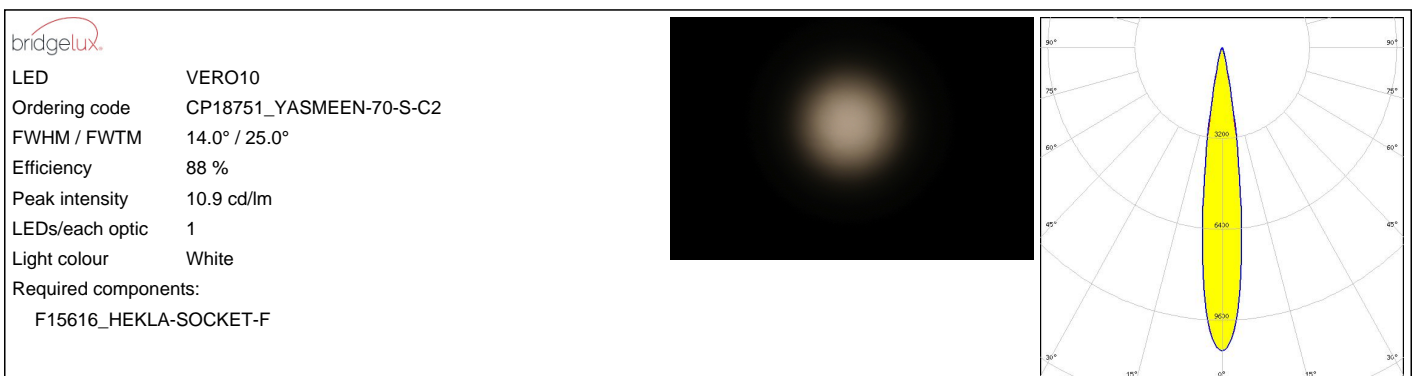
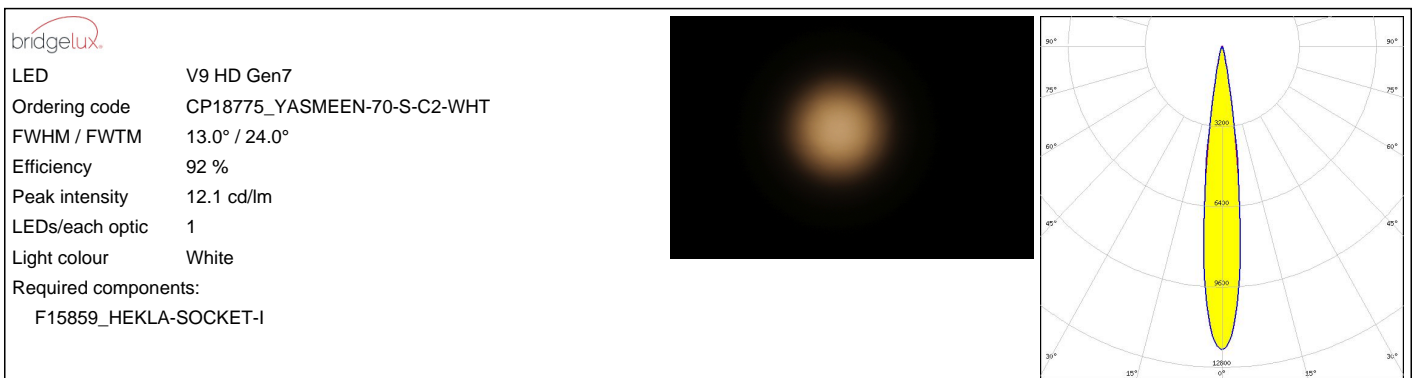
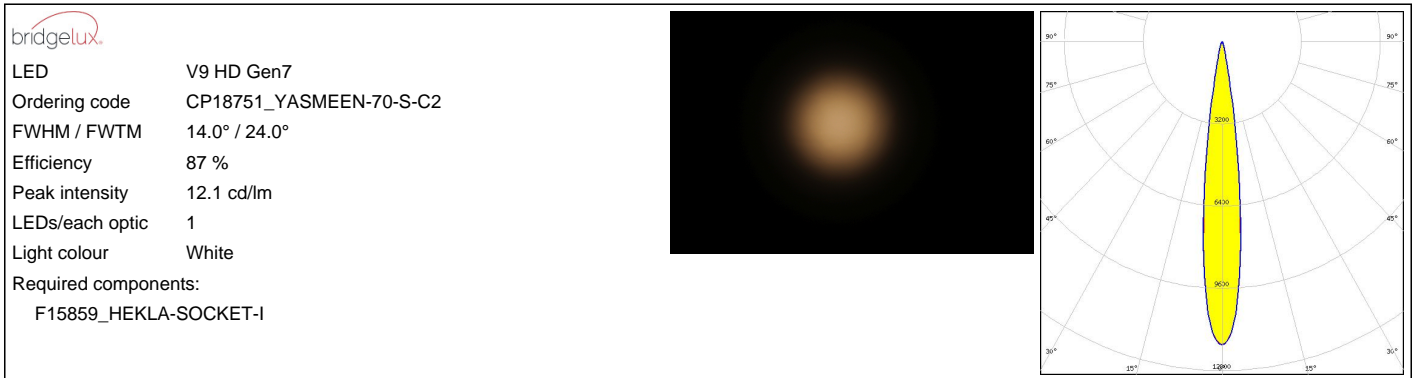
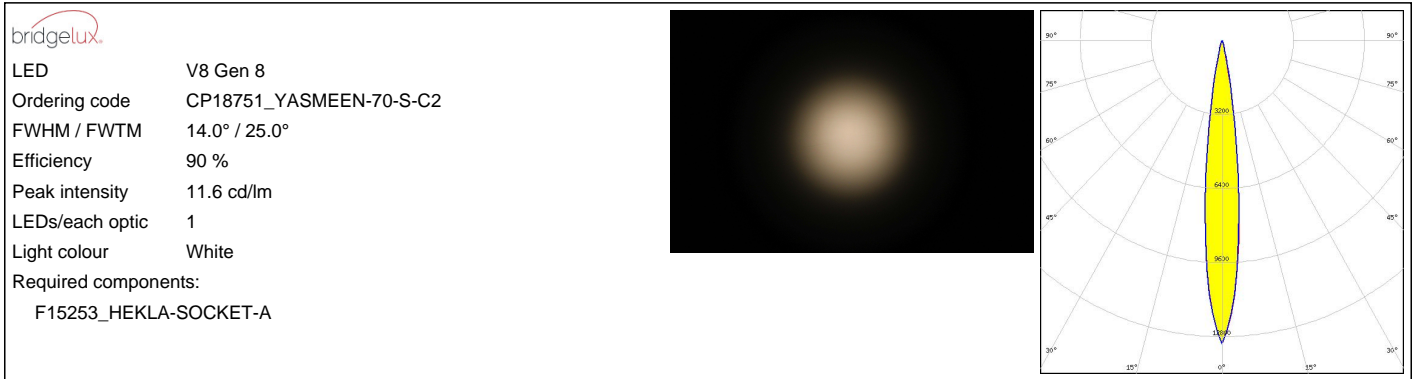

OPTICAL RESULTS (MEASURED):

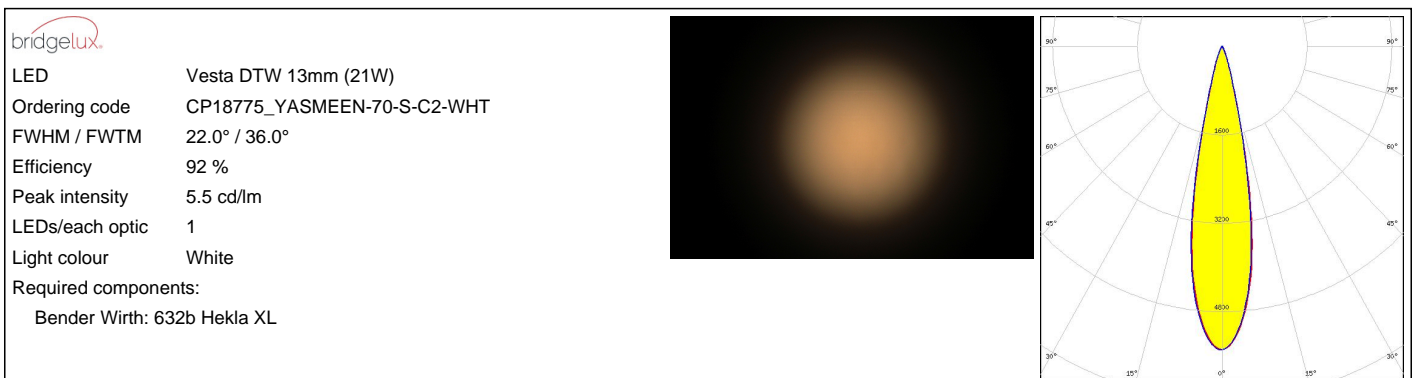
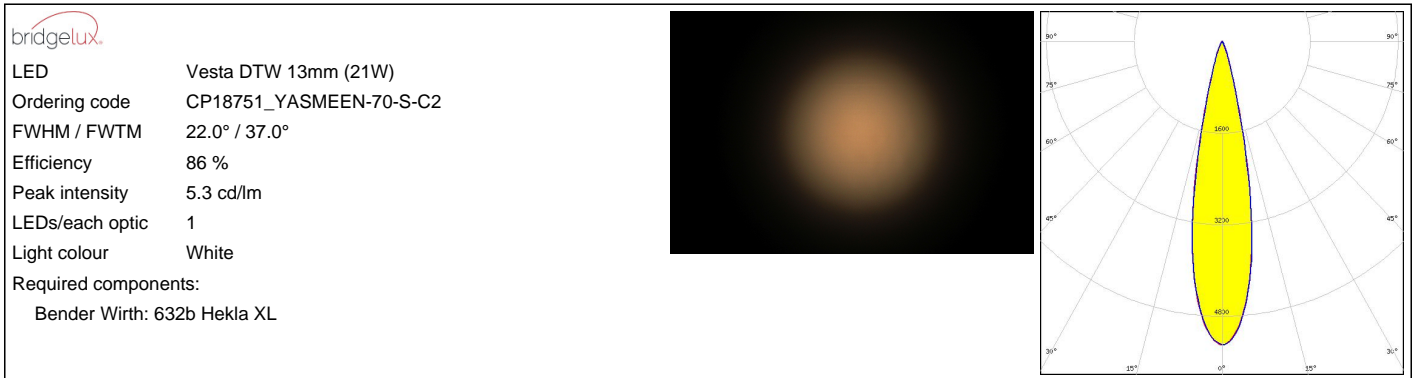
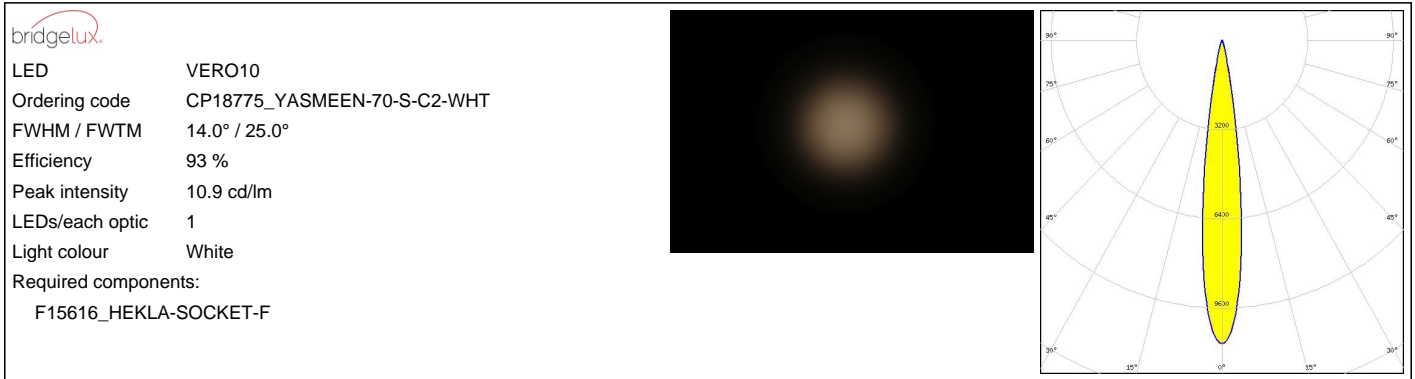

OPTICAL RESULTS (MEASURED):

bridgelux

LED Vesta DTW 15mm (33W)
 Ordering code CP18751_YASMEEN-70-S-C2
 FWHM / FWTM 23.0° / 39.0°
 Efficiency 86 %
 Peak intensity 4.9 cd/lm
 LEDs/each optic 1
 Light colour White
 Required components:
 Bender Wirth: 632b Hekla XL

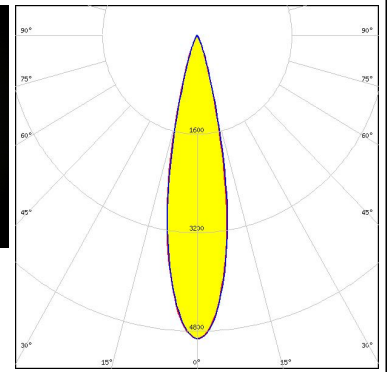

bridgelux

LED Vesta DTW 9mm (4W/6W/12W)
 Ordering code CP18775_YASMEEN-70-S-C2-WHT
 FWHM / FWTM 15.0° / 25.0°
 Efficiency 93 %
 Peak intensity 11 cd/lm
 LEDs/each optic 1
 Light colour White
 Required components:
 Bender Wirth: 652b Hekla

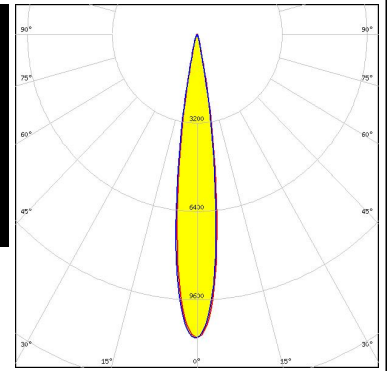
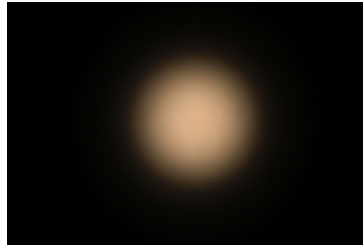

bridgelux

LED Vesta DTW 9mm (4W/6W/12W)
 Ordering code CP18751_YASMEEN-70-S-C2
 FWHM / FWTM 15.0° / 26.0°
 Efficiency 88 %
 Peak intensity 10.6 cd/lm
 LEDs/each optic 1
 Light colour White
 Required components:
 Bender Wirth: 652b Hekla

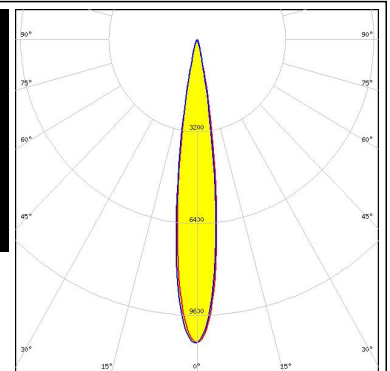

CITIZEN

LED CLL02x/CLU02x (LES10)
 Ordering code CP18751_YASMEEN-70-S-C2
 FWHM / FWTM 15.5° / 26.5 + 27.0°
 Efficiency 87 %
 Peak intensity 10 cd/lm
 LEDs/each optic 1
 Light colour White
 Required components:
 F17435_HEKLA-G2-C

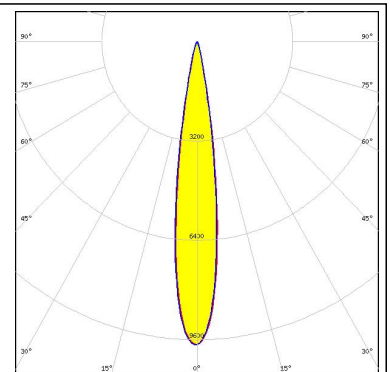

OPTICAL RESULTS (MEASURED):

CITIZEN

LED CLL02x/CLU02x (LES10)
 Ordering code CP18775_YASMEEN-70-S-C2-WHT
 FWHM / FWTM 15.5° / 26.5°
 Efficiency 92 %
 Peak intensity 10 cd/lm
 LEDs/each optic 1
 Light colour White
 Required components:
 F17435_HEKLA-G2-C

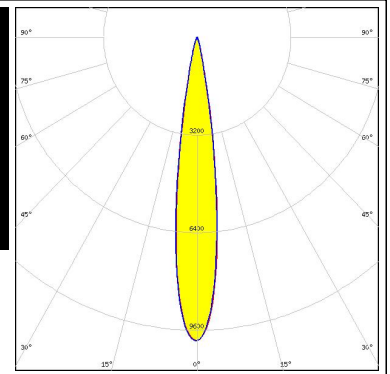
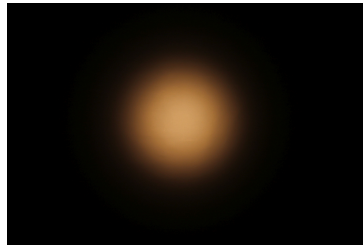

CITIZEN

LED CLL02x/CLU02x (LES10)
 Ordering code CP18751_YASMEEN-70-S-C2
 FWHM / FWTM 15.0° / 27.0°
 Efficiency 87 %
 Peak intensity 9.8 cd/lm
 LEDs/each optic 1
 Light colour White
 Required components:
 F17435_HEKLA-G2-C

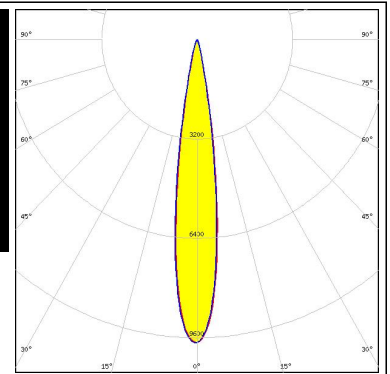
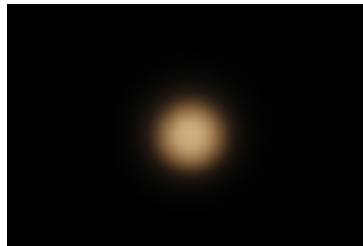

CITIZEN

LED CLL03x/CLU03x
 Ordering code CP18751_YASMEEN-70-S-C2
 FWHM / FWTM 21.0° / 36.5°
 Efficiency 85 %
 Peak intensity 5.5 cd/lm
 LEDs/each optic 1
 Light colour White
 Required components:
 F17438_HEKLA-G2-I

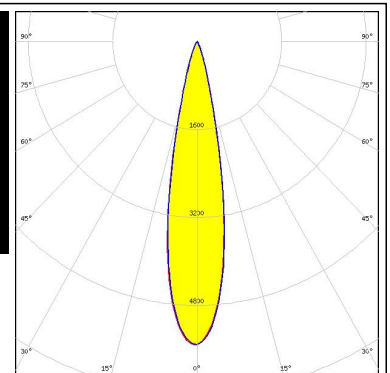
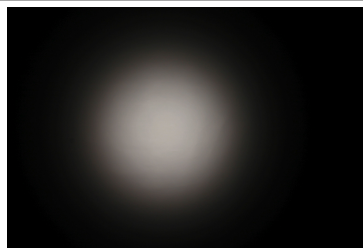

CITIZEN

LED CLL03x/CLU03x
 Ordering code CP18775_YASMEEN-70-S-C2-WHT
 FWHM / FWTM 21.0° / 37.0°
 Efficiency 92 %
 Peak intensity 5.6 cd/lm
 LEDs/each optic 1
 Light colour White
 Required components:
 F17438_HEKLA-G2-I

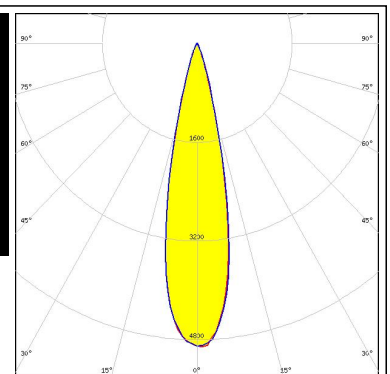

OPTICAL RESULTS (MEASURED):

CITIZEN

LED CLL03x/CLU03x
 Ordering code CP18768_YASMEEN-70-S-B2
 FWHM / FWTM 21.0° / 37.0°
 Efficiency 86 %
 Peak intensity 5.6 cd/lm
 LEDs/each optic 1
 Light colour White
 Required components:
 BJB: 47.360.1010

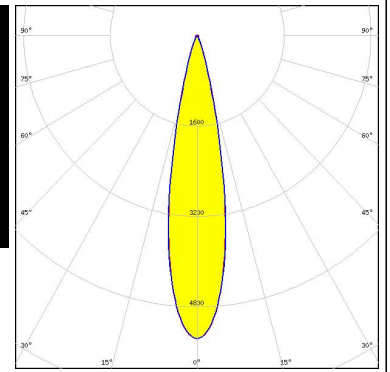
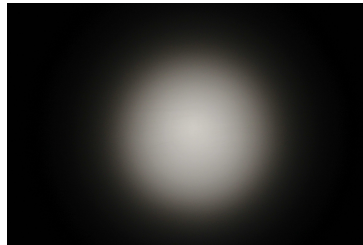

CREE LED

LED CMA1516
 Ordering code CP18751_YASMEEN-70-S-C2
 FWHM / FWTM 14.0° / 25.0°
 Efficiency 87 %
 Peak intensity 10.9 cd/lm
 LEDs/each optic 1
 Light colour White
 Required components:
 F17436_HEKLA-G2-D

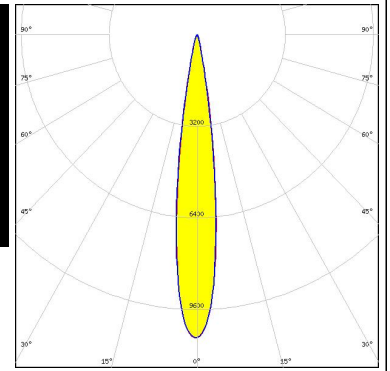
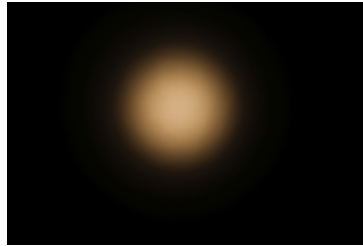

CREE LED

LED CMA1516
 Ordering code CP18775_YASMEEN-70-S-C2-WHT
 FWHM / FWTM 14.0° / 25.0°
 Efficiency 93 %
 Peak intensity 10.9 cd/lm
 LEDs/each optic 1
 Light colour White
 Required components:
 F17436_HEKLA-G2-D

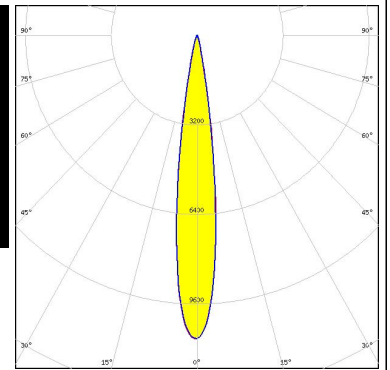
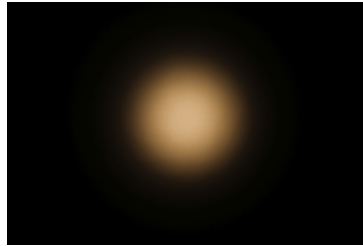

CREE LED

LED CMA1825
 Ordering code CP18775_YASMEEN-70-S-C2-WHT
 FWHM / FWTM 19.0° / 32.0°
 Efficiency 93 %
 Peak intensity 6.9 cd/lm
 LEDs/each optic 1
 Light colour White
 Required components:
 F15254_HEKLA-SOCKET-B

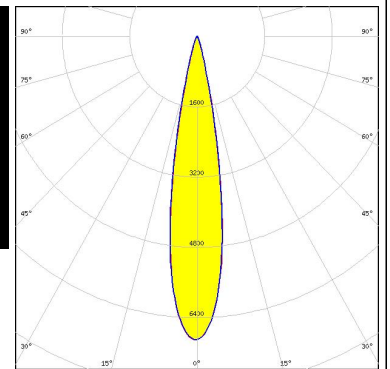

OPTICAL RESULTS (MEASURED):



LED CMA1825
Ordering code CP18751_YASMEEN-70-S-C2
FWHM / FWTM 19.0° / 32.0°
Efficiency 87 %
Peak intensity 6.9 cd/lm
LEDs/each optic 1
Light colour White
Required components:
 F15254_HEKLA-SOCKET-B

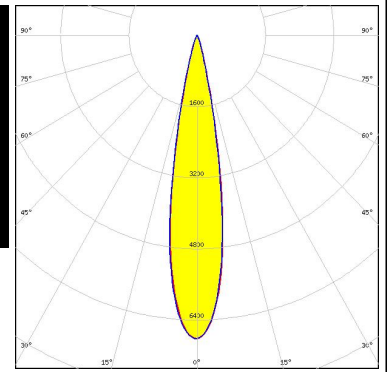

LED CMT14xx
Ordering code CP18775_YASMEEN-70-S-C2-WHT
FWHM / FWTM 15.0° / 26.0°
Efficiency 92 %
Peak intensity 10.1 cd/lm
LEDs/each optic 1
Light colour White
Required components:
 F17435_HEKLA-G2-C

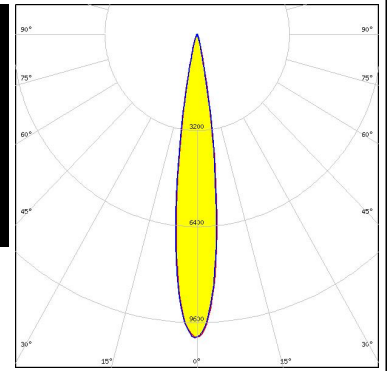
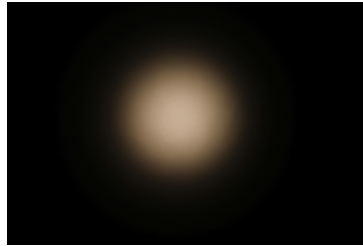

LED CMT14xx
Ordering code CP18751_YASMEEN-70-S-C2
FWHM / FWTM 15.0° / 26.0°
Efficiency 86 %
Peak intensity 10.1 cd/lm
LEDs/each optic 1
Light colour White
Required components:
 F17435_HEKLA-G2-C

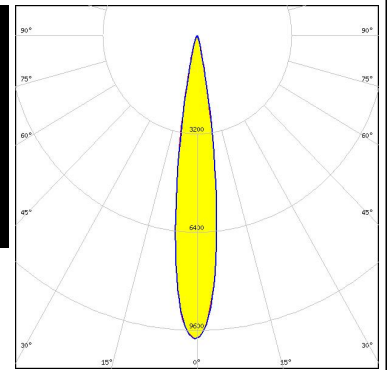
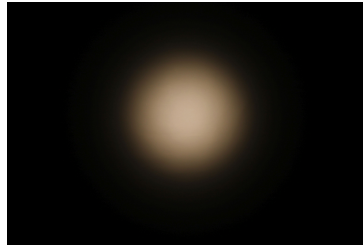

LED CMT19xx
Ordering code CP18751_YASMEEN-70-S-C2
FWHM / FWTM 21.0° / 36.0°
Efficiency 85 %
Peak intensity 5.4 cd/lm
LEDs/each optic 1
Light colour White
Required components:
 F17438_HEKLA-G2-I

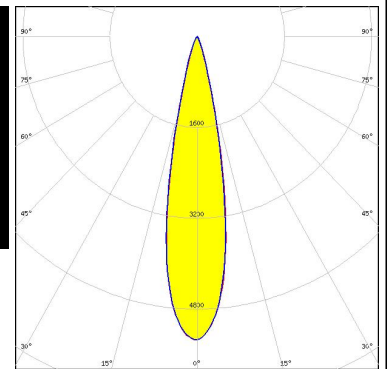

OPTICAL RESULTS (MEASURED):



LED CMT19xx
Ordering code CP18775_YASMEEN-70-S-C2-WHT
FWHM / FWTM 21.0° / 36.0°
Efficiency 92 %
Peak intensity 5.4 cd/lm
LEDs/each optic 1
Light colour White
Required components:
 F17438_HEKLA-G2-I

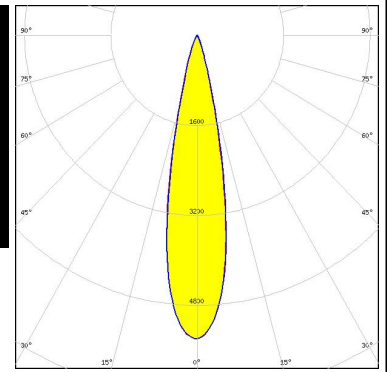
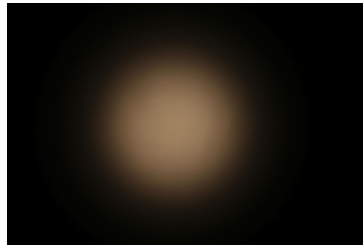

LED CMU15xx
Ordering code CP18751_YASMEEN-70-S-C2
FWHM / FWTM 23.0° / 39.0°
Efficiency 84 %
Peak intensity 4.7 cd/lm
LEDs/each optic 1
Light colour White
Required components:
 F17438_HEKLA-G2-I

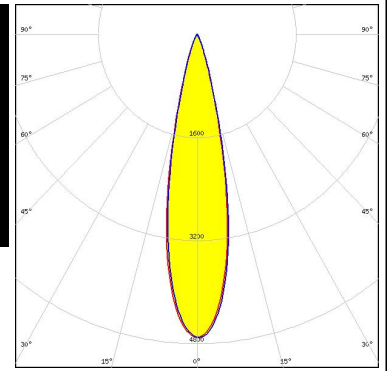

LED LUXEON CoB 1202/1203
Ordering code CP18751_YASMEEN-70-S-C2
FWHM / FWTM 14.0° / 24.0°
Efficiency 86 %
Peak intensity 11.2 cd/lm
LEDs/each optic 1
Light colour White
Required components:
 F17437_HEKLA-G2-H

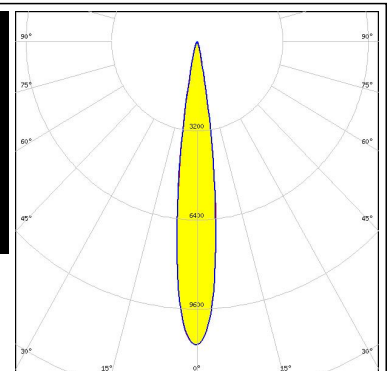

LED LUXEON CoB 1202/1203
Ordering code CP18775_YASMEEN-70-S-C2-WHT
FWHM / FWTM 14.0° / 24.0°
Efficiency 92 %
Peak intensity 11.2 cd/lm
LEDs/each optic 1
Light colour White
Required components:
 F17437_HEKLA-G2-H

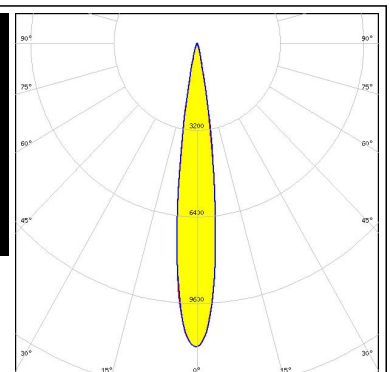
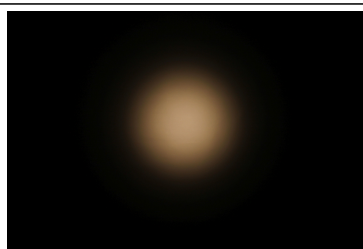

OPTICAL RESULTS (MEASURED):



LED COB L-Type (LES 11)
Ordering code CP18751_YASMEEN-70-S-C2
FWHM / FWTM 17.0° / 30.0°
Efficiency 86 %
Peak intensity 7.5 cd/lm
LEDs/each optic 1
Light colour White
Required components:
 F17437_HEKLA-G2-H

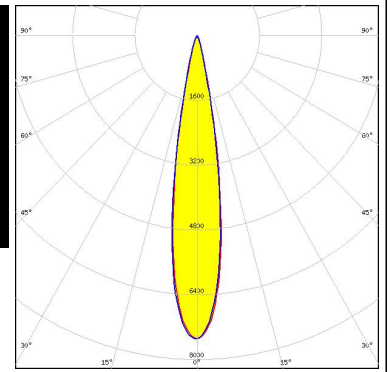

LED COB L-Type (LES 9)
Ordering code CP18775_YASMEEN-70-S-C2-WHT
FWHM / FWTM 13.0° / 24.0°
Efficiency 92 %
Peak intensity 11.9 cd/lm
LEDs/each optic 1
Light colour White
Required components:
 F17437_HEKLA-G2-H

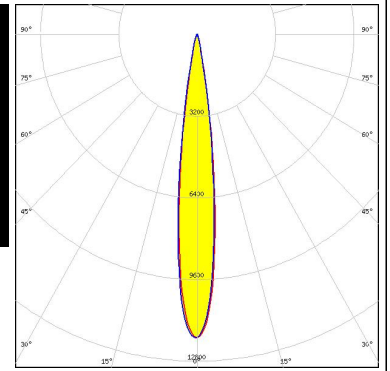
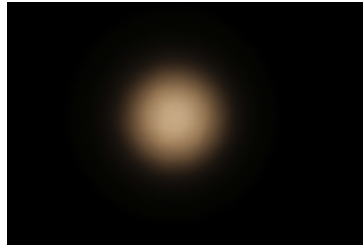

LED COB S-Type (LES 7)
Ordering code CP18751_YASMEEN-70-S-C2
FWHM / FWTM 20.0° / 34.0°
Efficiency 85 %
Peak intensity 6.1 cd/lm
LEDs/each optic 1
Light colour White
Required components:
 F17438_HEKLA-G2-I

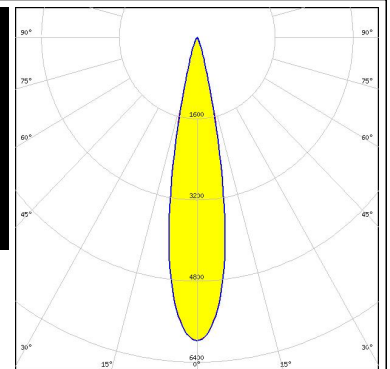

LED COB S-Type (LES 7)
Ordering code CP18775_YASMEEN-70-S-C2-WHT
FWHM / FWTM 20.0° / 34.0°
Efficiency 92 %
Peak intensity 6.1 cd/lm
LEDs/each optic 1
Light colour White
Required components:
 F17438_HEKLA-G2-I

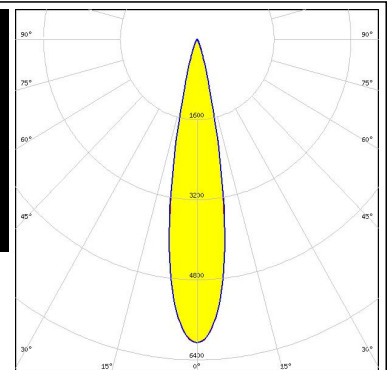

OPTICAL RESULTS (MEASURED):

PHILIPS

LED Fortimo SLM L09 CoB
 Ordering code CP18751_YASMEEN-70-S-C2
 FWHM / FWTM 14.0° / 25.0°
 Efficiency 86 %
 Peak intensity 11.1 cd/lm
 LEDs/each optic 1
 Light colour White
 Required components:
 F17437_HEKLA-G2-H

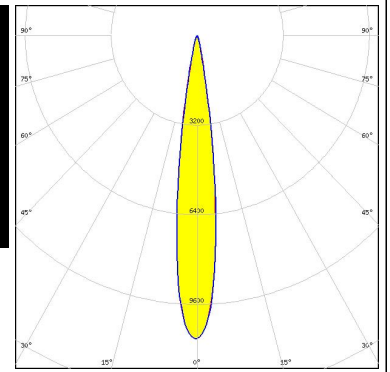

PHILIPS

LED Fortimo SLM L09 CoB
 Ordering code CP18775_YASMEEN-70-S-C2-WHT
 FWHM / FWTM 14.0° / 25.0°
 Efficiency 92 %
 Peak intensity 11.1 cd/lm
 LEDs/each optic 1
 Light colour White
 Required components:
 F17437_HEKLA-G2-H

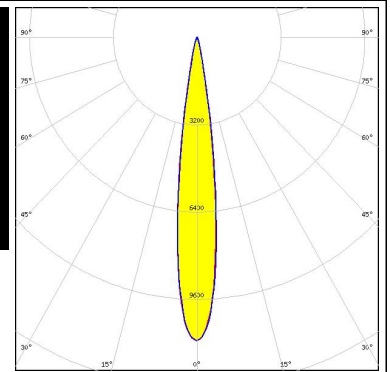

SAMSUNG

LED LC016D / LC019D / LC026D / LC033D
 Ordering code CP18775_YASMEEN-70-S-C2-WHT
 FWHM / FWTM 23.0° / 40.0°
 Efficiency 92 %
 Peak intensity 4.8 cd/lm
 LEDs/each optic 1
 Light colour White
 Required components:
 F17438_HEKLA-G2-I

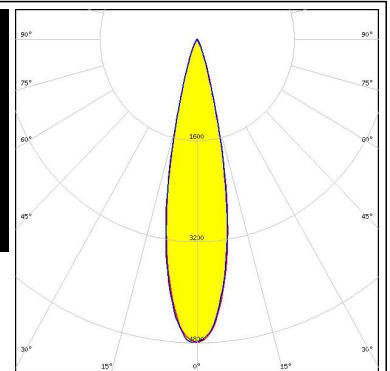
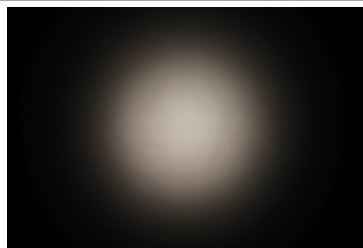

SAMSUNG

LED LC016D / LC019D / LC026D / LC033D
 Ordering code CP18751_YASMEEN-70-S-C2
 FWHM / FWTM 23.0° / 39.0°
 Efficiency 85 %
 Peak intensity 4.7 cd/lm
 LEDs/each optic 1
 Light colour White
 Required components:
 F17438_HEKLA-G2-I

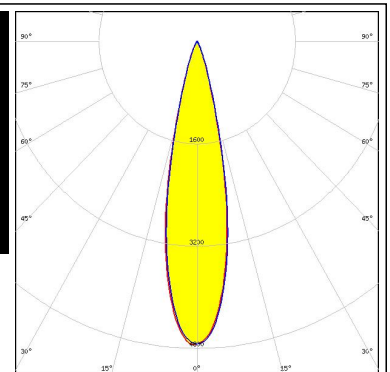
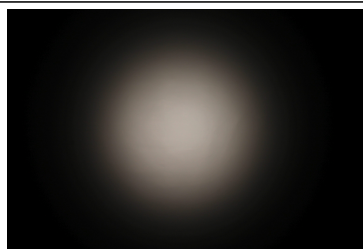

OPTICAL RESULTS (MEASURED):

SAMSUNG

LED LC030C/040C G2
 Ordering code CP18775_YASMEEN-70-S-C2-WHT
 FWHM / FWTM 17.0° / 30.0°
 Efficiency 92 %
 Peak intensity 7.7 cd/m
 LEDs/each optic 1
 Light colour White
 Required components:
 F17438_HEKLA-G2-I

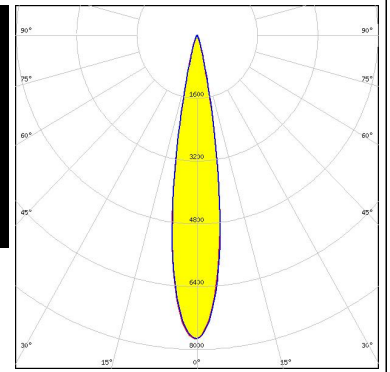
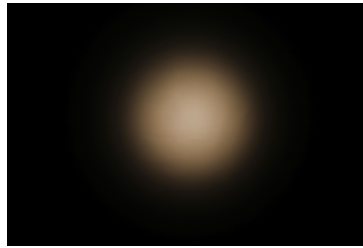

SAMSUNG

LED LC030C/040C G2
 Ordering code CP18751_YASMEEN-70-S-C2
 FWHM / FWTM 17.0° / 30.0°
 Efficiency 86 %
 Peak intensity 7.7 cd/m
 LEDs/each optic 1
 Light colour White
 Required components:
 F17438_HEKLA-G2-I

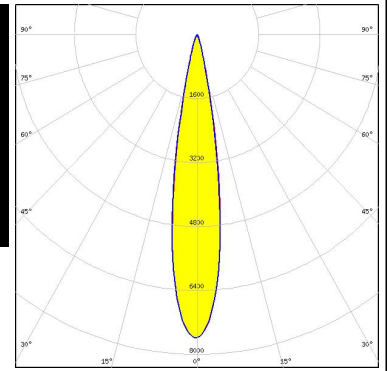

SEOUL SEMICONDUCTOR
 LED MJT COB LES 14.5
 Ordering code CP18751_YASMEEN-70-S-C2
 FWHM / FWTM 23.0° / 38.0°
 Efficiency 85 %
 Peak intensity 4.8 cd/m
 LEDs/each optic 1
 Light colour White
 Required components:
 F17438_HEKLA-G2-I

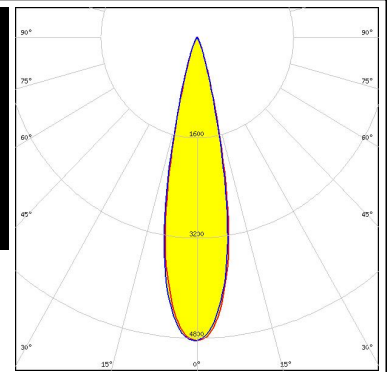
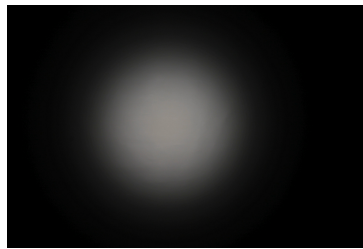

SEOUL SEMICONDUCTOR
 LED MJT COB LES 14.5
 Ordering code CP18775_YASMEEN-70-S-C2-WHT
 FWHM / FWTM 23.0° / 39.0°
 Efficiency 92 %
 Peak intensity 4.9 cd/m
 LEDs/each optic 1
 Light colour White
 Required components:
 F17438_HEKLA-G2-I

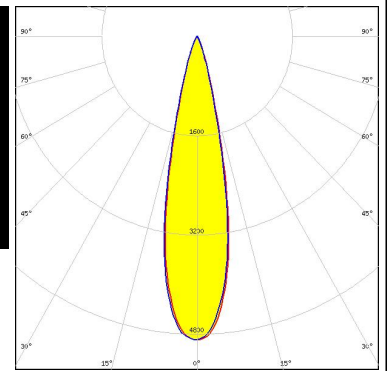
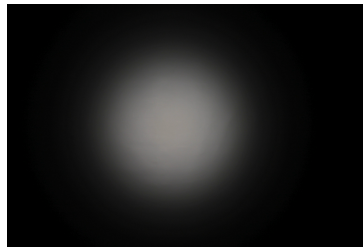

OPTICAL RESULTS (MEASURED):

TRIDONIC

LED SLE G7 LES09
Ordering code CP18775_YASMEEN-70-S-C2-WHT
FWHM / FWTM 15.0° / 25.0°
Efficiency 93 %
Peak intensity 11.3 cd/lm
LEDs/each optic 1
Light colour White
Required components:
F17435_HEKLA-G2-C

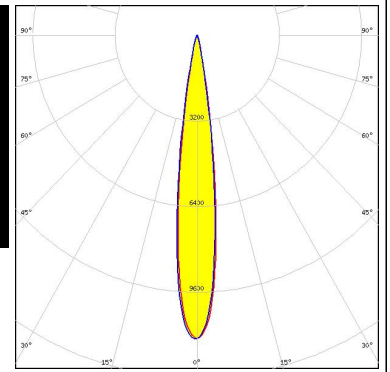
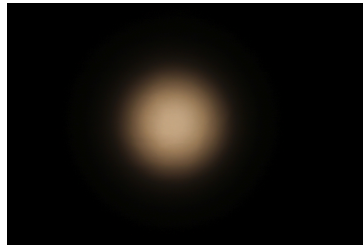

TRIDONIC

LED SLE G7 LES15
Ordering code CP18751_YASMEEN-70-S-C2
FWHM / FWTM 22.0° / 38.0°
Efficiency 85 %
Peak intensity 5.1 cd/lm
LEDs/each optic 1
Light colour White
Required components:
F17438_HEKLA-G2-I

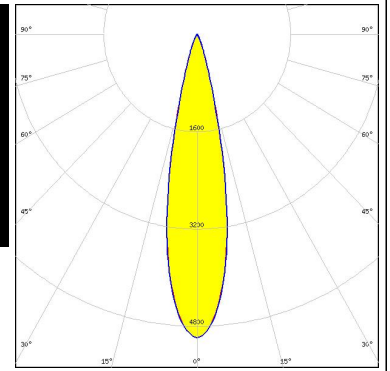

TRIDONIC

LED SLE G7 LES15
Ordering code CP18775_YASMEEN-70-S-C2-WHT
FWHM / FWTM 22.0° / 38.0°
Efficiency 92 %
Peak intensity 5.1 cd/lm
LEDs/each optic 1
Light colour White
Required components:
F17438_HEKLA-G2-I

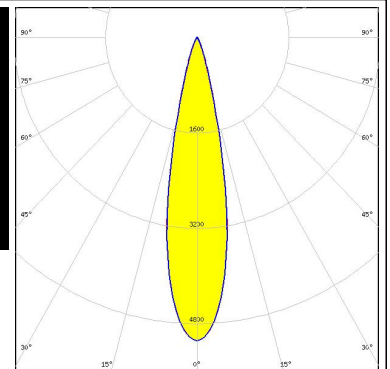

OPTICAL RESULTS (SIMULATED):

bridgelux.

LED V10 Gen 8
 Ordering code CP18768_YASMEEN-70-S-B2
 FWHM / FWTM 16.0° / 28.0°
 Efficiency 88 %
 Peak intensity 9.9 cd/lm
 LEDs/each optic 1
 Light colour White
 Required components:
 BJB: 47.360.1020

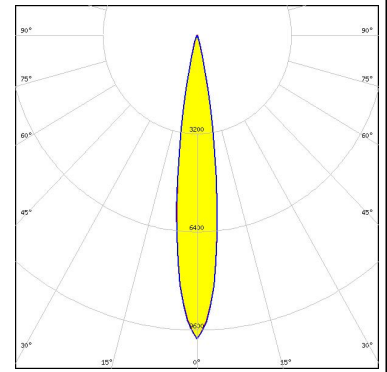

bridgelux.

LED V13 Gen7
 Ordering code C17238_YASMEEN-70-S
 FWHM / FWTM 22.0° / 36.0°
 Efficiency 90 %
 Peak intensity 5.9 cd/lm
 LEDs/each optic 1
 Light colour White
 Required components:

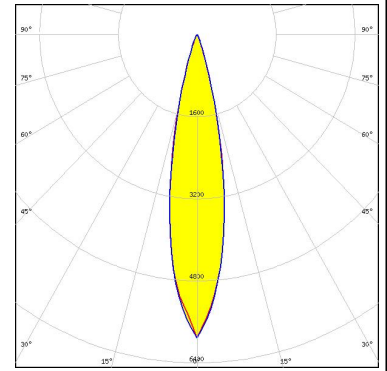

bridgelux.

LED V6 HD Gen 7
 Ordering code CP18751_YASMEEN-70-S-C2
 FWHM / FWTM 12.0° / 22.0°
 Efficiency 89 %
 Peak intensity 15.6 cd/lm
 LEDs/each optic 1
 Light colour White
 Required components:
 F15255_HEKLA-SOCKET-C

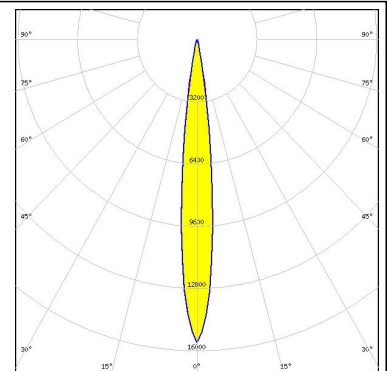

bridgelux.

LED Vesta TW 13mm (25W) CSP
 Ordering code CP18751_YASMEEN-70-S-C2
 FWHM / FWTM 20.0° / 34.0°
 Efficiency 90 %
 Peak intensity 6.5 cd/lm
 LEDs/each optic 1
 Light colour White
 Required components:
 C16142_HEKLA-SOCKET-K

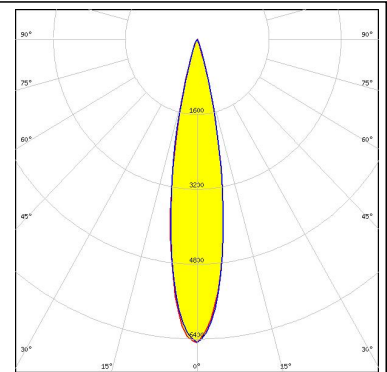

OPTICAL RESULTS (SIMULATED):



LED Vesta TW 9mm (12W) CSP
Ordering code CP18751_YASMEEN-70-S-C2
FWHM / FWTM 16.0° / 30.0°
Efficiency 90 %
Peak intensity 8.6 cd/lm
LEDs/each optic 1
Light colour White
Required components:
 C16142_HEKLA-SOCKET-K

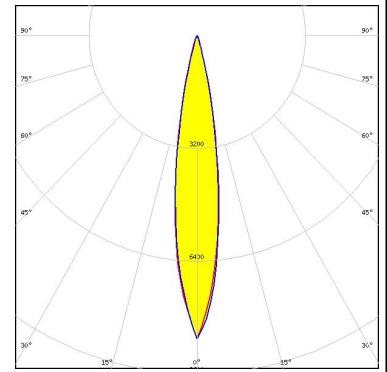

CITIZEN

LED CLL02x/CLU02x (LES10)
Ordering code CP18768_YASMEEN-70-S-B2
FWHM / FWTM 16.0° / 28.0°
Efficiency 88 %
Peak intensity 9.8 cd/lm
LEDs/each optic 1
Light colour White
Required components:
 BJB: 47.360.1020

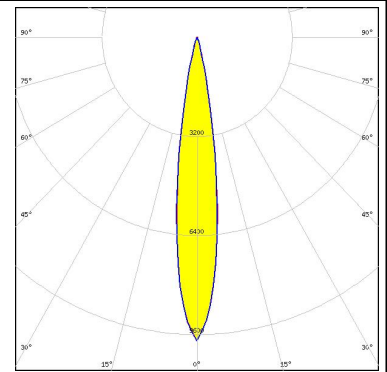

CITIZEN

LED CLU712/713
FWHM / FWTM 14.0° / 26.0°
Efficiency 94 %
Peak intensity 11.4 cd/lm
LEDs/each optic 1
Light colour White
Required components:

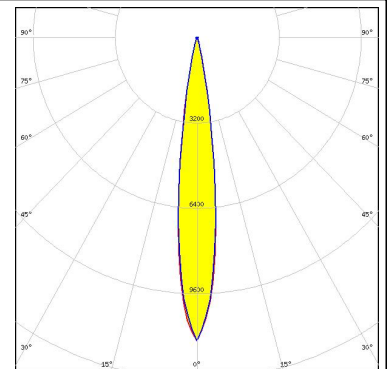

CITIZEN

LED CLU712/713
Ordering code CP18775_YASMEEN-70-S-C2-WHT
FWHM / FWTM 14.0° / 26.0°
Efficiency 93 %
Peak intensity 11.3 cd/lm
LEDs/each optic 1
Light colour White
Required components:
 F17438_HEKLA-G2-I

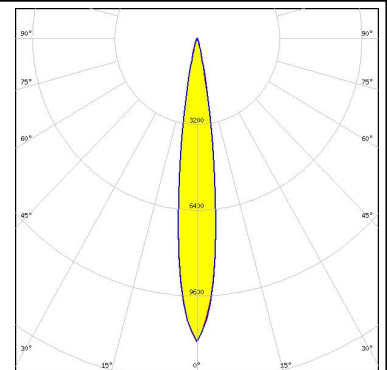

OPTICAL RESULTS (SIMULATED):

CITIZEN

LED CLU712/713
Ordering code C17238_YASMEEN-70-S
FWHM / FWTM 14.0° / 26.0°
Efficiency 94 %
Peak intensity 11.4 cd/lm
LEDs/each optic 1
Light colour White
Required components:

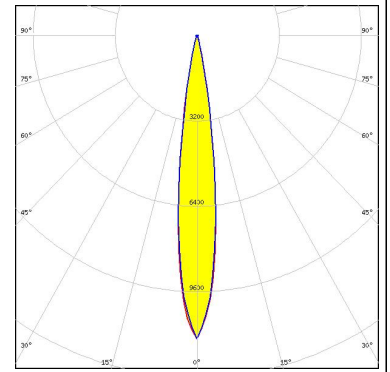

CITIZEN

LED CLU712/713
Ordering code CP18768_YASMEEN-70-S-B2
FWHM / FWTM 14.0° / 26.0°
Efficiency 88 %
Peak intensity 11.2 cd/lm
LEDs/each optic 1
Light colour White
Required components:
BJB: 47.360.1010

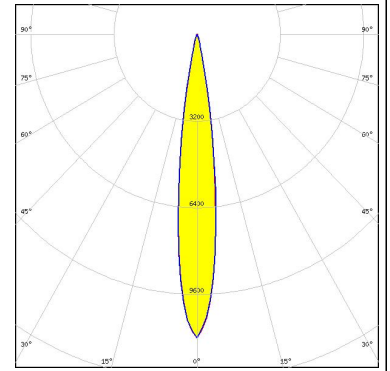

CITIZEN

LED CLU712/713
Ordering code CP18751_YASMEEN-70-S-C2
FWHM / FWTM 14.0° / 26.0°
Efficiency 87 %
Peak intensity 11.3 cd/lm
LEDs/each optic 1
Light colour White
Required components:
F17438_HEKLA-G2-I

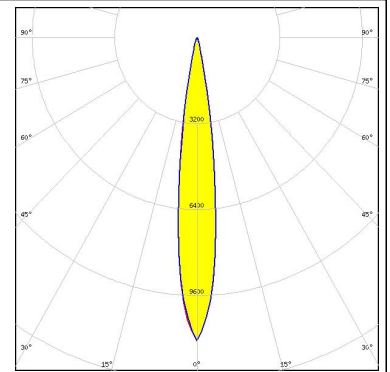

CITIZEN

LED CLU7A2/7A3
Ordering code CP18768_YASMEEN-70-S-B2
FWHM / FWTM 10.0° / 20.0°
Efficiency 89 %
Peak intensity 18.7 cd/lm
LEDs/each optic 1
Light colour White
Required components:
BJB: 47.360.1020

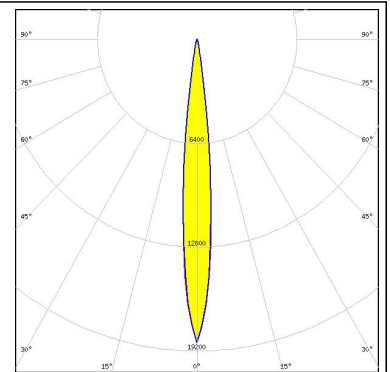

OPTICAL RESULTS (SIMULATED):



LED CHA0304
Ordering code CP18751_YASMEEN-70-S-C2
FWHM / FWTM 10.0° / 20.0°
Efficiency 88 %
Peak intensity 19.5 cd/lm
LEDs/each optic 1
Light colour White
Required components:
 F17435_HEKLA-G2-C

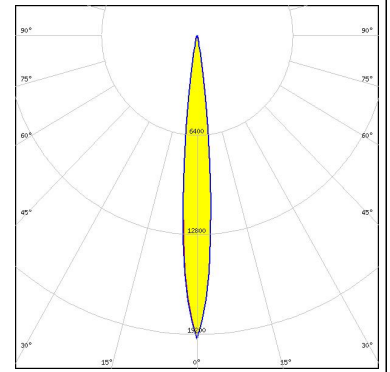

LED CHA0410
Ordering code CP18751_YASMEEN-70-S-C2
FWHM / FWTM 10.0° / 20.0°
Efficiency 88 %
Peak intensity 18.6 cd/lm
LEDs/each optic 1
Light colour White
Required components:
 F17435_HEKLA-G2-C

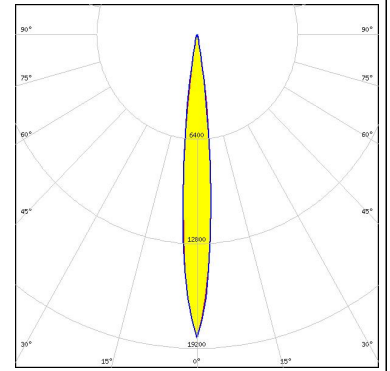

LED CHA0612
Ordering code CP18751_YASMEEN-70-S-C2
FWHM / FWTM 12.0° / 22.0°
Efficiency 88 %
Peak intensity 15.3 cd/lm
LEDs/each optic 1
Light colour White
Required components:
 F17435_HEKLA-G2-C

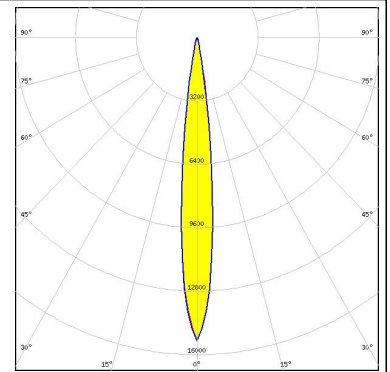

LED CMA1306
Ordering code CP18751_YASMEEN-70-S-C2
FWHM / FWTM 12.0° / 22.0°
Efficiency 88 %
Peak intensity 16.1 cd/lm
LEDs/each optic 1
Light colour White
Required components:
 F17435_HEKLA-G2-C

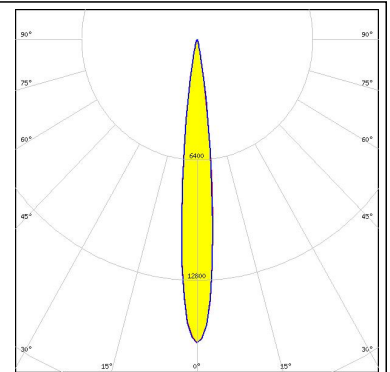

OPTICAL RESULTS (SIMULATED):

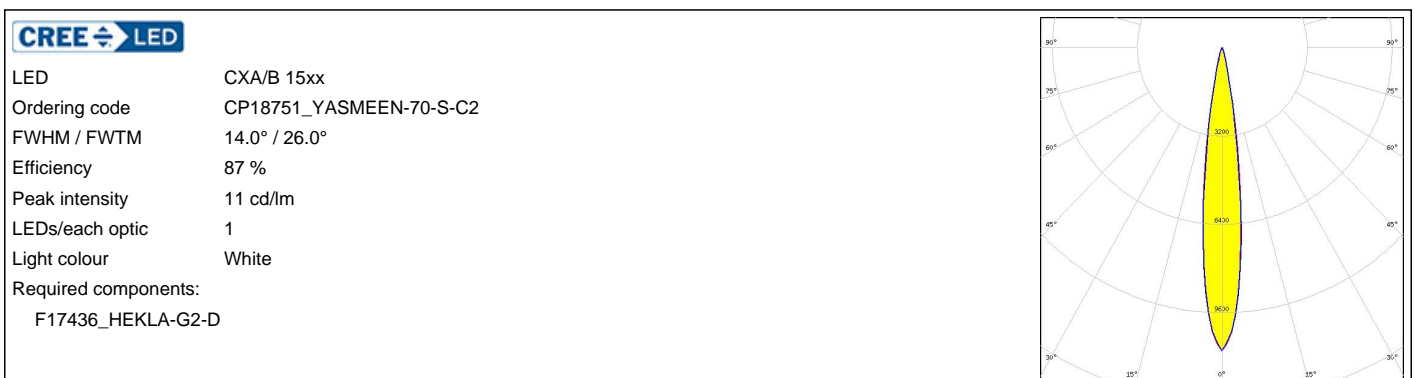

OPTICAL RESULTS (SIMULATED):



LED CXA/B 1830
Ordering code CP18751_YASMEEN-70-S-C2
FWHM / FWTM 22.0° / 36.0°
Efficiency 87 %
Peak intensity 5.5 cd/lm
LEDs/each optic 1
Light colour White
Required components:
Bender Wirth: 637b Hekla

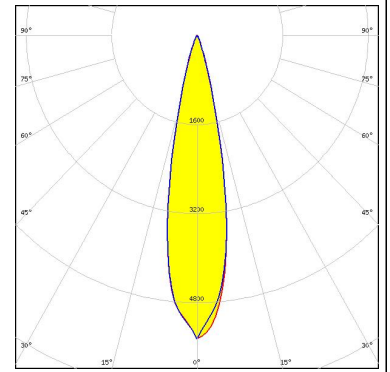

PHILIPS

LED Fortimo SLM L09 CoB
Ordering code CP18751_YASMEEN-70-S-C2
FWHM / FWTM 16.0° / 28.0°
Efficiency 88 %
Peak intensity 10 cd/lm
LEDs/each optic 1
Light colour White
Required components:
F17435_HEKLA-G2-C

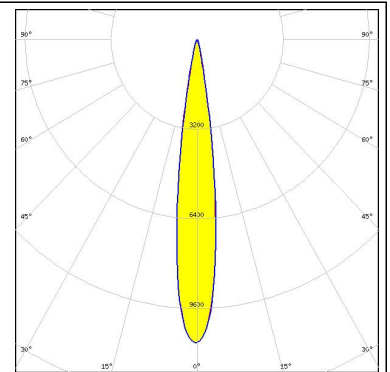

PHILIPS

LED Fortimo SLM L13 CoB
Ordering code CP18751_YASMEEN-70-S-C2
FWHM / FWTM 16.0° / 28.0°
Efficiency 87 %
Peak intensity 10.1 cd/lm
LEDs/each optic 1
Light colour White
Required components:
Bender Wirth: 632a Hekla XL

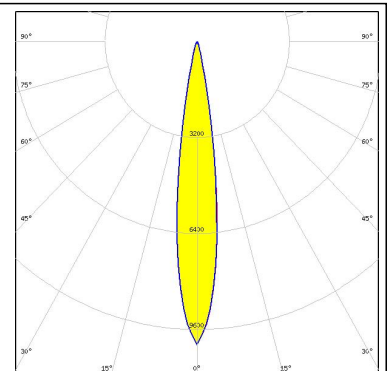

SAMSUNG

LED LC003D / LC006D / LC009D / LC013D
Ordering code CP18751_YASMEEN-70-S-C2
FWHM / FWTM 16.0° / 28.0°
Efficiency 87 %
Peak intensity 8.8 cd/lm
LEDs/each optic 1
Light colour White
Required components:
F17435_HEKLA-G2-C

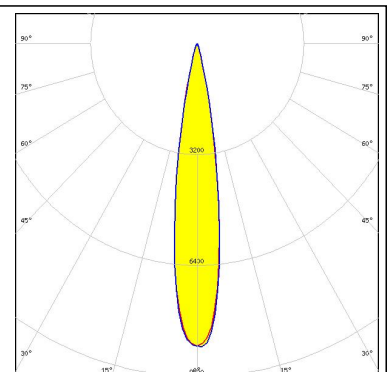

OPTICAL RESULTS (SIMULATED):

SAMSUNG

LED LC003D / LC006D / LC009D / LC013D
Ordering code CP18768_YASMEEN-70-S-B2
FWHM / FWTM 16.0° / 29.0°
Efficiency 85 %
Peak intensity 9 cd/lm
LEDs/each optic 1
Light colour White
Required components:
BJB: 47.360.1020

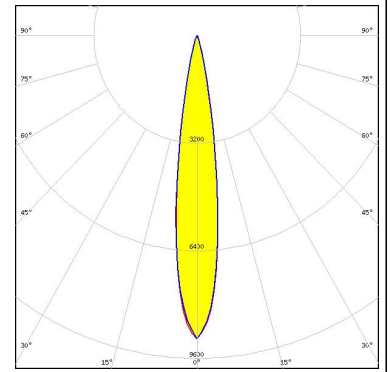

SAMSUNG

LED LC010C G2
Ordering code CP18768_YASMEEN-70-S-B2
FWHM / FWTM 12.0° / 22.0°
Efficiency 89 %
Peak intensity 15.7 cd/lm
LEDs/each optic 1
Light colour White
Required components:
BJB: 47.360.1020

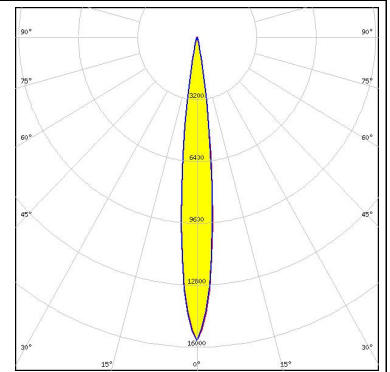

SAMSUNG

LED LC016D / LC019D / LC026D / LC033D
Ordering code CP18768_YASMEEN-70-S-B2
FWHM / FWTM 24.0° / 42.0°
Efficiency 85 %
Peak intensity 4.4 cd/lm
LEDs/each optic 1
Light colour White
Required components:
BJB: 47.360.1010

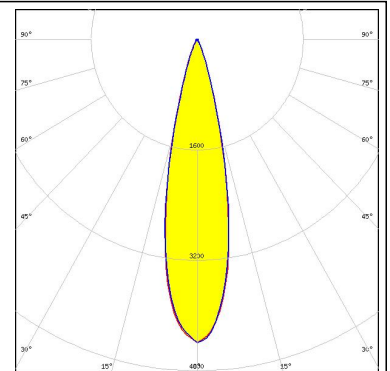

SAMSUNG

LED LC020C G2
Ordering code CP18768_YASMEEN-70-S-B2
FWHM / FWTM 14.0° / 26.0°
Efficiency 88 %
Peak intensity 10.9 cd/lm
LEDs/each optic 1
Light colour White
Required components:
BJB: 47.360.1010

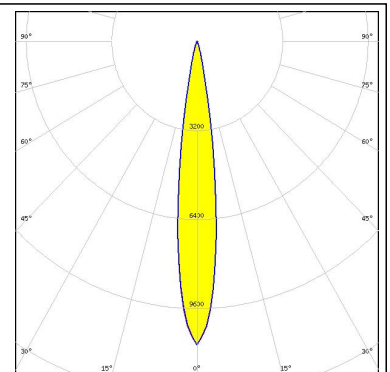

OPTICAL RESULTS (SIMULATED):

SAMSUNG

LED LC030C/040C G2
Ordering code CP18768_YASMEEN-70-S-B2
FWHM / FWTM 18.0° / 32.0°
Efficiency 88 %
Peak intensity 7.2 cd/lm
LEDs/each optic 1
Light colour White
Required components:
BJB: 47.360.1010

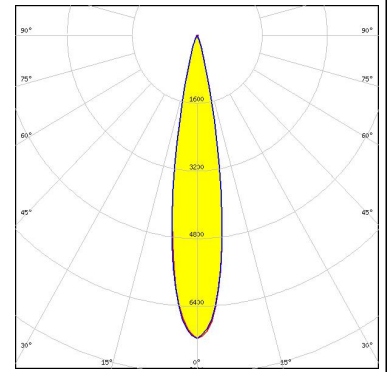

TRIDONIC

LED SLE G7 LES13
Ordering code CP18751_YASMEEN-70-S-C2
FWHM / FWTM 20.0° / 34.0°
Efficiency 87 %
Peak intensity 6.1 cd/lm
LEDs/each optic 1
Light colour White
Required components:
F17438_HEKLA-G2-I

