

YASMEEN-70-WW

~60° wide beam. Assembly with holder C (LEDiL HEKLA) and B (BJB and B+W). Black and white versions.

SPECIFICATION:

Dimensions	Ø 70.0 mm
Height	34.6 mm
Fastening	socket
ROHS compliant	yes ⓘ



MATERIALS:

Component	Type	Material	Colour	Finish
YASMEEN-70-WW	Single lens	PMMA	clear	
YASMEEN-70-HLD2-C	Holder C	PC	black	
YASMEEN-70-HLD2-B	Holder B	PC	black	
YASMEEN-70-HLD2-C-WHT	Holder C	PC	white	
YASMEEN-70-HLD2-B-WHT	Holder B	PC	white	

ORDERING INFORMATION:

Component	Qty in box	MOQ	MPQ	Box weight (kg)
C17241_YASMEEN-70-WW	105	105	15	8.2
Assembly				
CP18785_YASMEEN-70-WW-B2-WHT	105	105	15	9.7
CP18778_YASMEEN-70-WW-C2-WHT	105	105	15	9.6
CP18771_YASMEEN-70-WW-B2	105	105	15	9.7
CP18764_YASMEEN-70-WW-C2	105	105	15	9.6

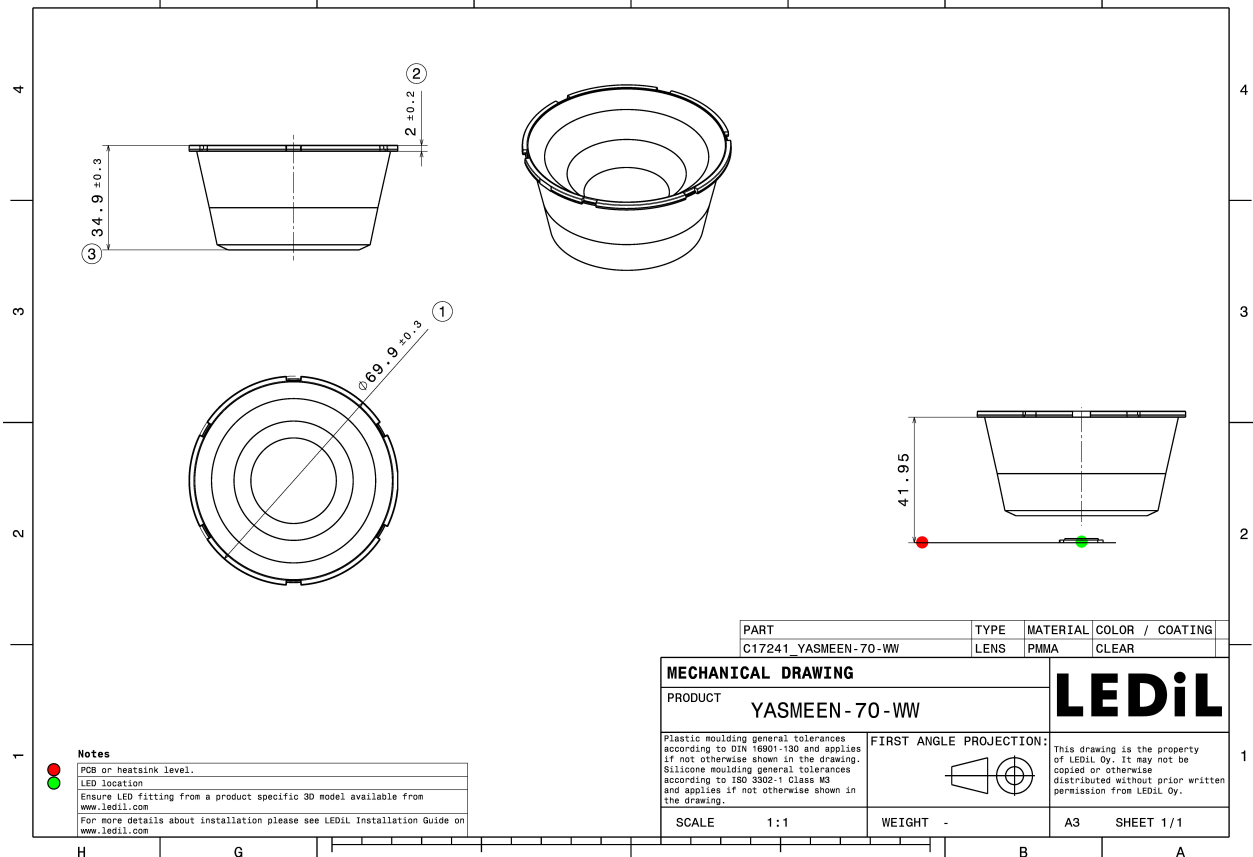
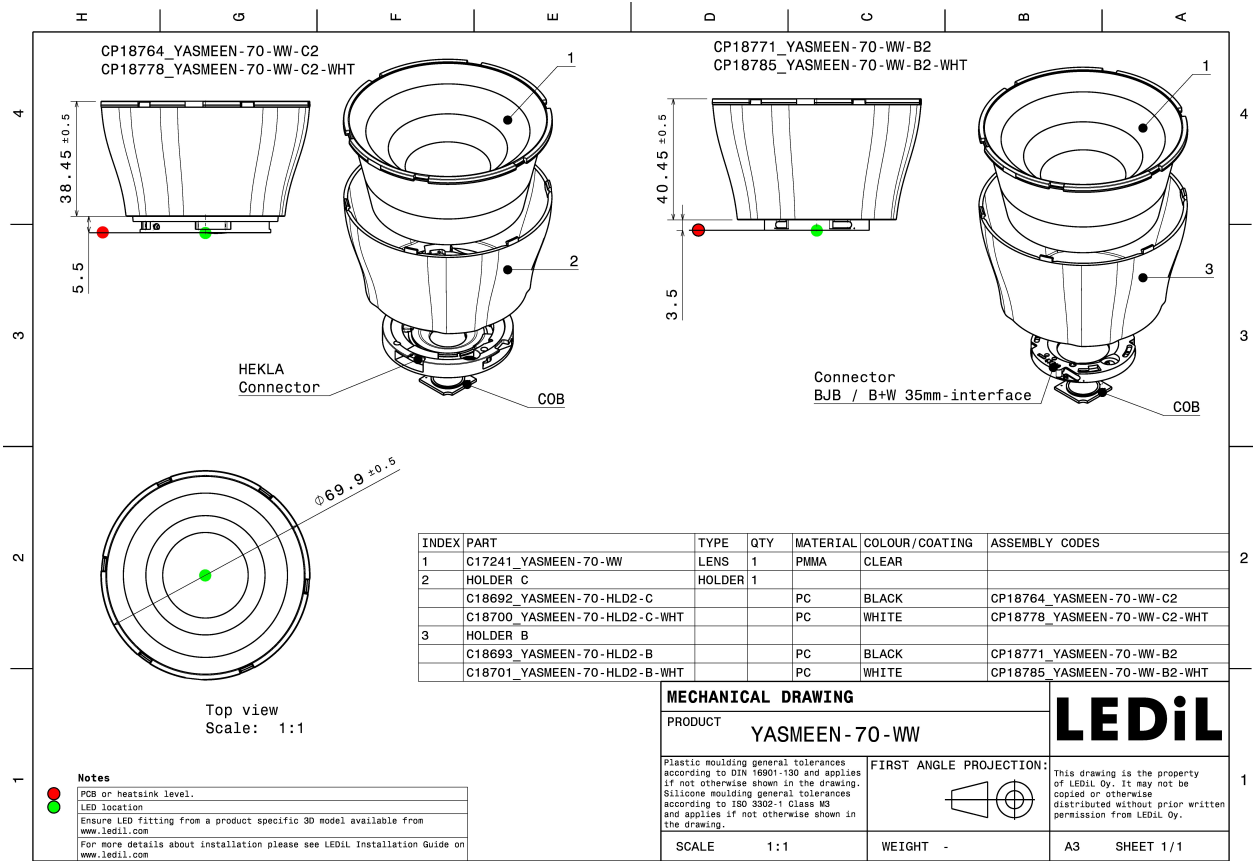

See also our general installation guide: www.ledil.com/installation_guide

OPTICAL RESULTS (MEASURED):



OPTICAL RESULTS (MEASURED):



LED V8 Gen 8
Ordering code CP18764_YASMEEN-70-WW-C2
FWHM / FWTM 56.0° / 76.0°
Efficiency 85 %
Peak intensity 1 cd/lm
LEDs/each optic 1
Light colour White
Required components:
 F15253_HEKLA-SOCKET-A

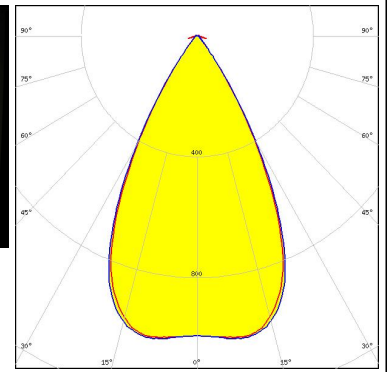
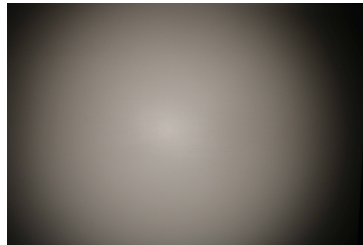

LED V9 HD Gen7
Ordering code CP18778_YASMEEN-70-WW-C2-WHT
FWHM / FWTM 55.0° / 76.0°
Efficiency 89 %
Peak intensity 1 cd/lm
LEDs/each optic 1
Light colour White
Required components:
 F15859_HEKLA-SOCKET-I

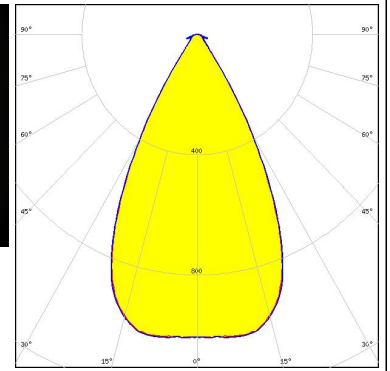

LED V9 HD Gen7
Ordering code CP18764_YASMEEN-70-WW-C2
FWHM / FWTM 55.0° / 74.0°
Efficiency 81 %
Peak intensity 1 cd/lm
LEDs/each optic 1
Light colour White
Required components:
 F15859_HEKLA-SOCKET-I

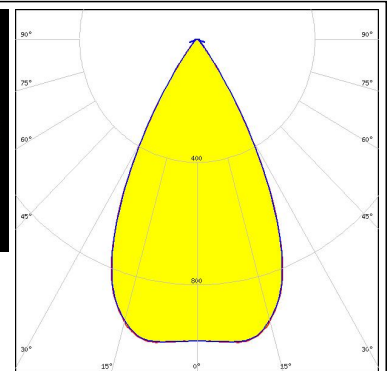
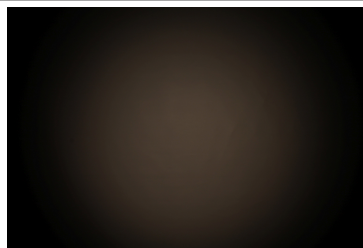

LED VERO10
Ordering code CP18778_YASMEEN-70-WW-C2-WHT
FWHM / FWTM 55.5° / 76.5°
Efficiency 90 %
Peak intensity 1 cd/lm
LEDs/each optic 1
Light colour White
Required components:
 F15616_HEKLA-SOCKET-F

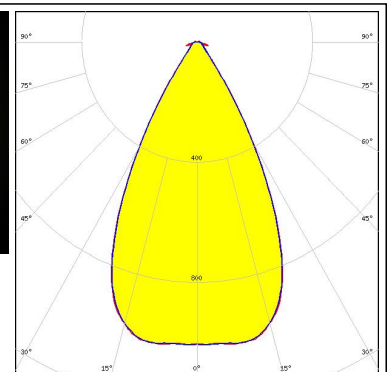
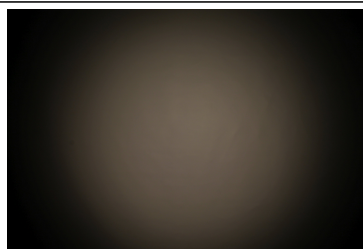

OPTICAL RESULTS (MEASURED):

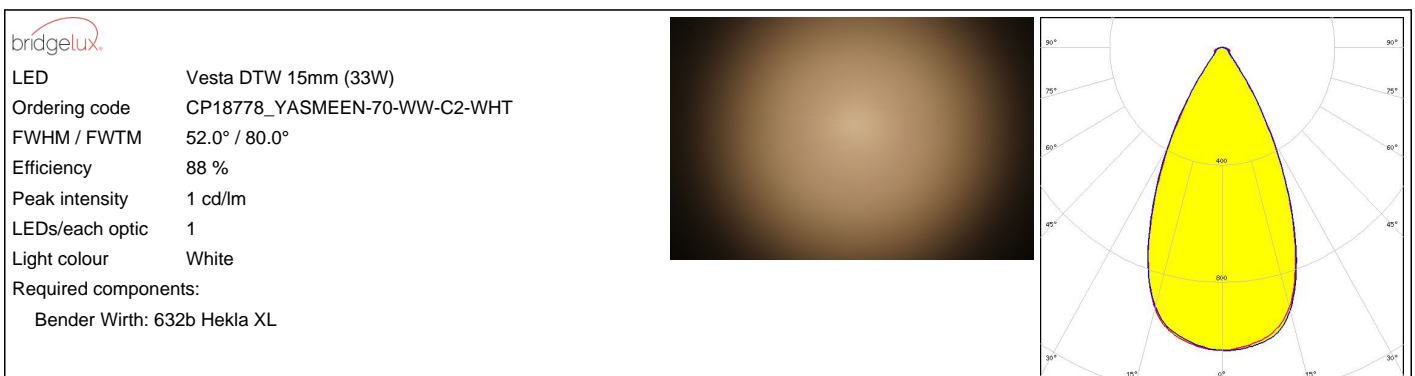
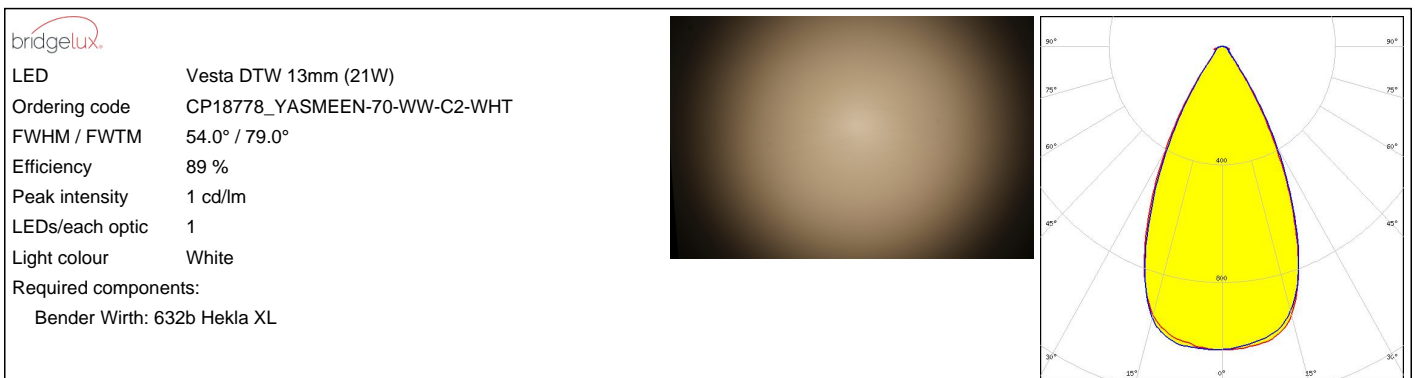
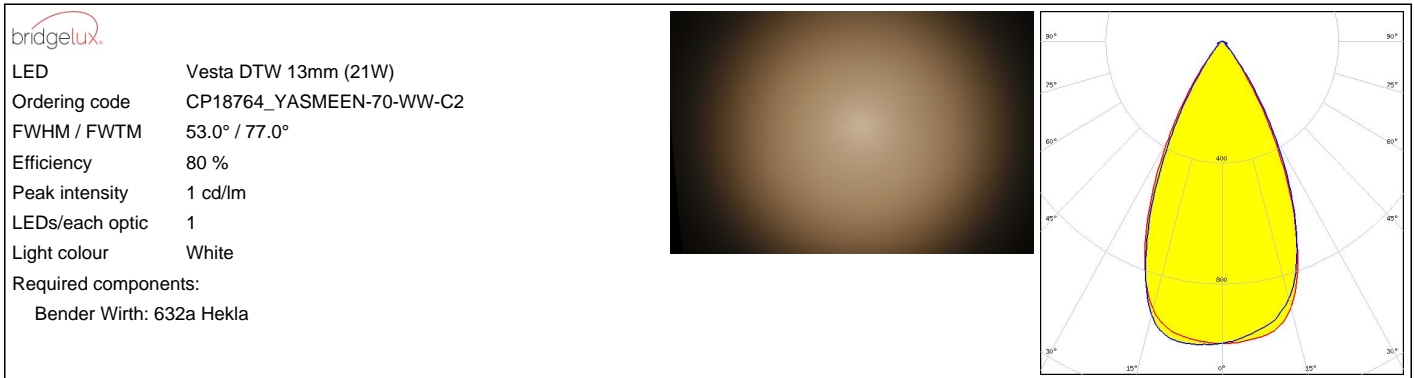

OPTICAL RESULTS (MEASURED):



LED Vesta DTW 15mm (33W)
Ordering code CP18764_YASMEEN-70-WW-C2
FWHM / FWTM 52.0° / 77.0°
Efficiency 80 %
Peak intensity 1 cd/lm
LEDs/each optic 1
Light colour White
Required components:
 Bender Wirth: 632b Hekla XL

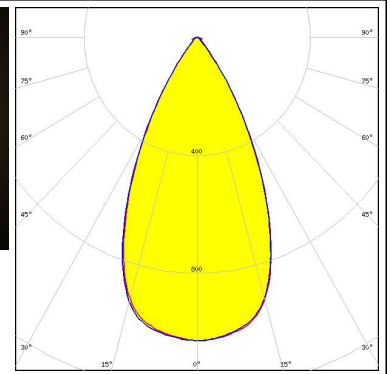
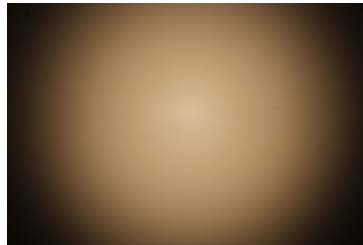

LED Vesta DTW 9mm (4W/6W/12W)
Ordering code CP18778_YASMEEN-70-WW-C2-WHT
FWHM / FWTM 56.0° / 77.0°
Efficiency 90 %
Peak intensity 1 cd/lm
LEDs/each optic 1
Light colour White
Required components:
 Bender Wirth: 652b Hekla

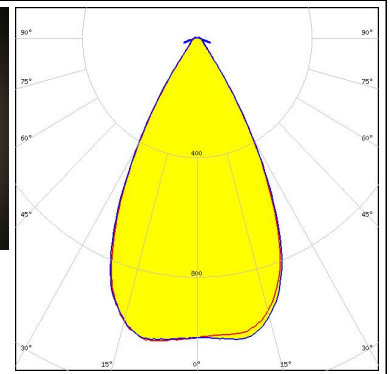

LED Vesta DTW 9mm (4W/6W/12W)
Ordering code CP18764_YASMEEN-70-WW-C2
FWHM / FWTM 55.0° / 76.0°
Efficiency 82 %
Peak intensity 1 cd/lm
LEDs/each optic 1
Light colour White
Required components:
 Bender Wirth: 652b Hekla

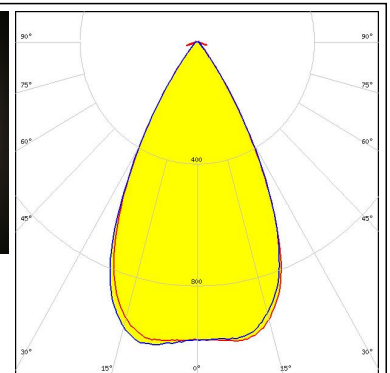
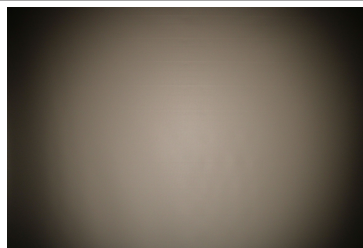

CITIZEN

LED CLL02x/CLU02x (LES10)
Ordering code CP18778_YASMEEN-70-WW-C2-WHT
FWHM / FWTM 55.0° / 77.0°
Efficiency 90 %
Peak intensity 1 cd/lm
LEDs/each optic 1
Light colour White
Required components:
 F17435_HEKLA-G2-C

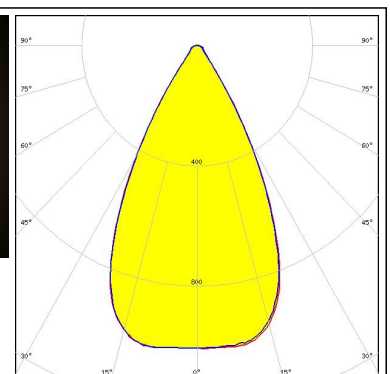
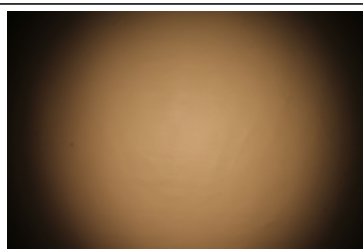

OPTICAL RESULTS (MEASURED):

CITIZEN

LED CLL02x/CLU02x (LES10)
Ordering code CP18764_YASMEEN-70-WW-C2
FWHM / FWTM 54.0° / 75.0°
Efficiency 81 %
Peak intensity 1 cd/lm
LEDs/each optic 1
Light colour White
Required components:
F17435_HEKLA-G2-C

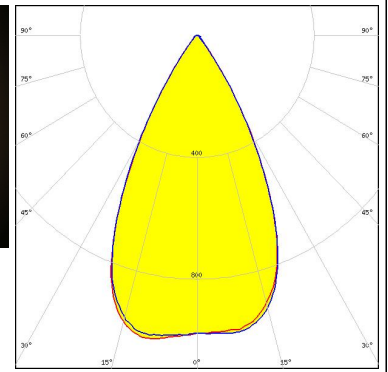
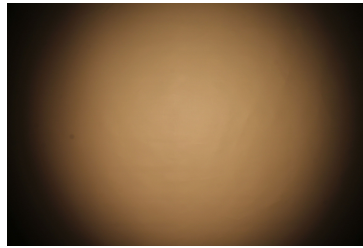

CITIZEN

LED CLL03x/CLU03x
Ordering code CP18778_YASMEEN-70-WW-C2-WHT
FWHM / FWTM 52.0° / 78.0°
Efficiency 89 %
Peak intensity 1.1 cd/lm
LEDs/each optic 1
Light colour White
Required components:
F17435_HEKLA-G2-C

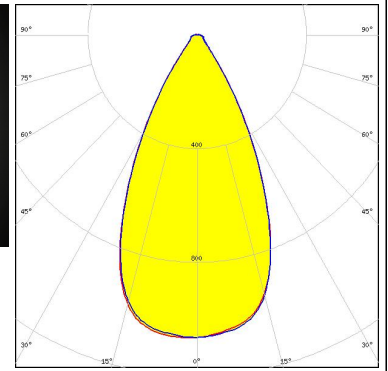

CITIZEN

LED CLL03x/CLU03x
Ordering code CP18764_YASMEEN-70-WW-C2
FWHM / FWTM 52.0° / 76.0°
Efficiency 80 %
Peak intensity 1 cd/lm
LEDs/each optic 1
Light colour White
Required components:
F17438_HEKLA-G2-I

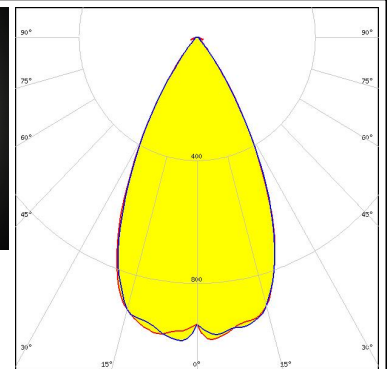

LED CMA1516
Ordering code CP18764_YASMEEN-70-WW-C2
FWHM / FWTM 55.0° / 75.0°
Efficiency 81 %
Peak intensity 1 cd/lm
LEDs/each optic 1
Light colour White
Required components:
F17436_HEKLA-G2-D

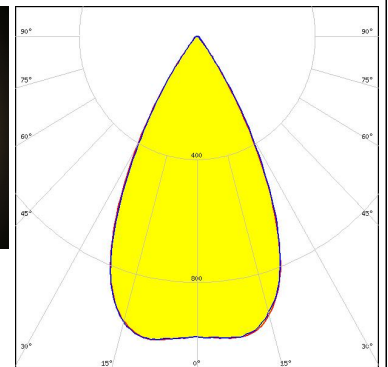
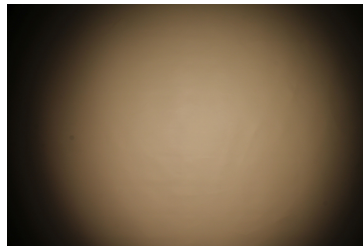

OPTICAL RESULTS (MEASURED):



LED CMA1516
Ordering code CP18778_YASMEEN-70-WW-C2-WHT
FWHM / FWTM 55.0° / 77.0°
Efficiency 90 %
Peak intensity 1 cd/lm
LEDs/each optic 1
Light colour White
Required components:
F17436_HEKLA-G2-D

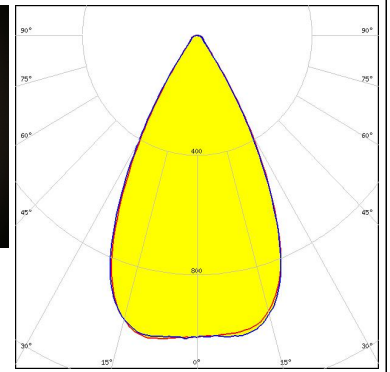
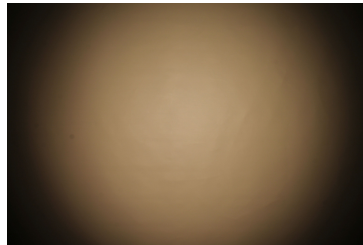

LED CMA1825
Ordering code CP18778_YASMEEN-70-WW-C2-WHT
FWHM / FWTM 54.0° / 78.0°
Efficiency 90 %
Peak intensity 1 cd/lm
LEDs/each optic 1
Light colour White
Required components:
F15254_HEKLA-SOCKET-B

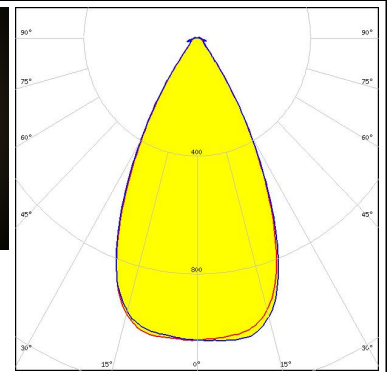
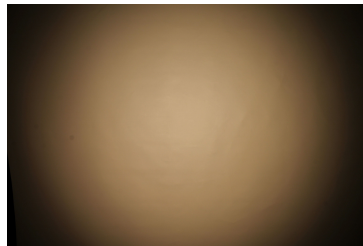

LED CMA1825
Ordering code CP18764_YASMEEN-70-WW-C2
FWHM / FWTM 54.0° / 76.0°
Efficiency 81 %
Peak intensity 1 cd/lm
LEDs/each optic 1
Light colour White
Required components:
F15254_HEKLA-SOCKET-B

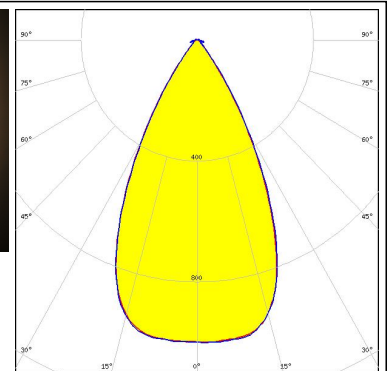
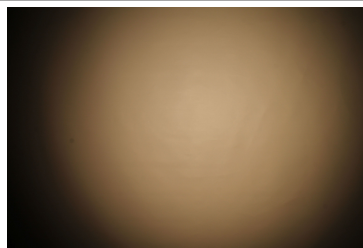

LED CMT14xx
Ordering code CP18778_YASMEEN-70-WW-C2-WHT
FWHM / FWTM 55.0° / 77.0°
Efficiency 90 %
Peak intensity 1 cd/lm
LEDs/each optic 1
Light colour White
Required components:
F17435_HEKLA-G2-C

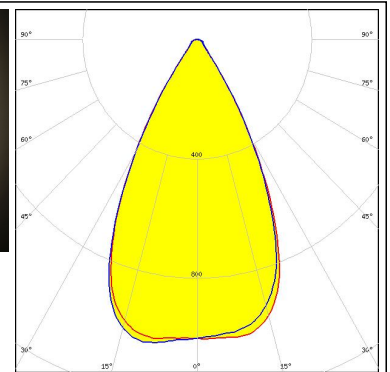
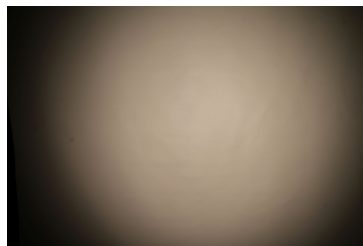

OPTICAL RESULTS (MEASURED):



LED CMT14xx
Ordering code CP18764_YASMEEN-70-WW-C2
FWHM / FWTM 55.0° / 75.0°
Efficiency 81 %
Peak intensity 1 cd/lm
LEDs/each optic 1
Light colour White
Required components:
 F17435_HEKLA-G2-C

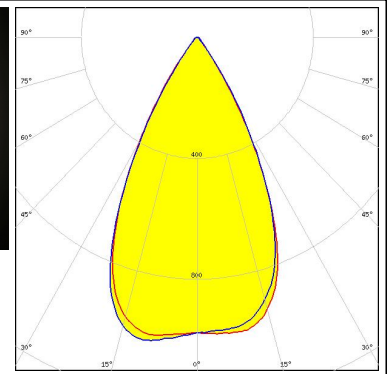
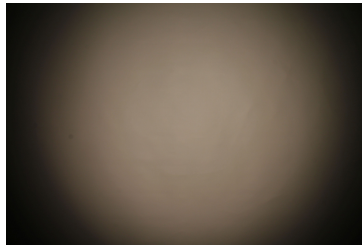

LED CMT19xx
Ordering code CP18764_YASMEEN-70-WW-C2
FWHM / FWTM 52.0° / 76.0°
Efficiency 80 %
Peak intensity 1 cd/lm
LEDs/each optic 1
Light colour White
Required components:
 F17438_HEKLA-G2-I

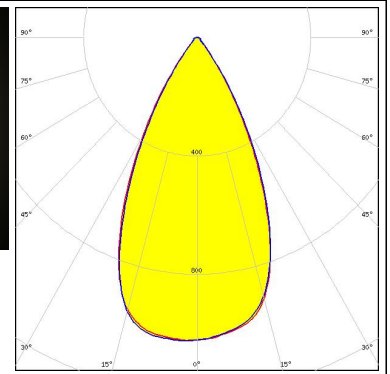

LED CMT19xx
Ordering code CP18778_YASMEEN-70-WW-C2-WHT
FWHM / FWTM 52.0° / 78.0°
Efficiency 89 %
Peak intensity 1.1 cd/lm
LEDs/each optic 1
Light colour White
Required components:
 F17438_HEKLA-G2-I

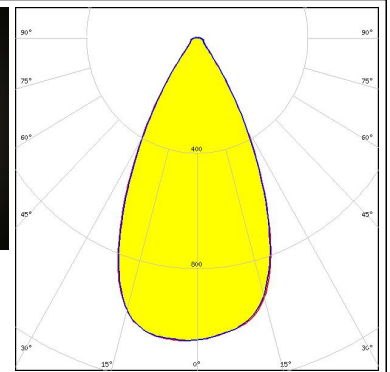

LED CMU15xx
Ordering code CP18764_YASMEEN-70-WW-C2
FWHM / FWTM 52.0° / 77.0°
Efficiency 79 %
Peak intensity 1 cd/lm
LEDs/each optic 1
Light colour White
Required components:
 F17438_HEKLA-G2-I

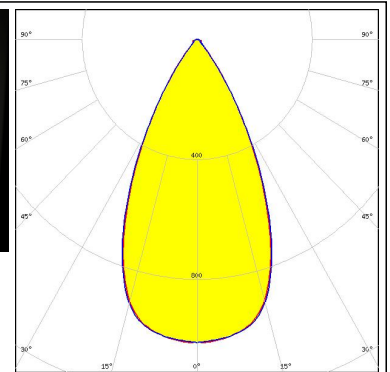
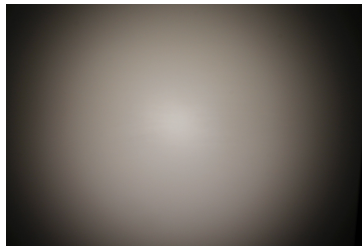

OPTICAL RESULTS (MEASURED):

LUMILEDS

LED LUXEON CoB 1202/1203
Ordering code CP18778_YASMEEN-70-WW-C2-WHT
FWHM / FWTM 55.0° / 76.0°
Efficiency 90 %
Peak intensity 1 cd/lm
LEDs/each optic 1
Light colour White
Required components:
F17437_HEKLA-G2-H

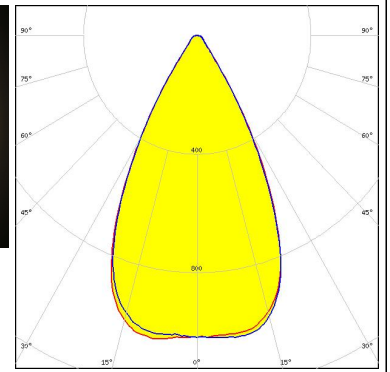

LUMILEDS

LED LUXEON CoB 1202/1203
Ordering code CP18764_YASMEEN-70-WW-C2
FWHM / FWTM 55.0° / 74.0°
Efficiency 81 %
Peak intensity 1 cd/lm
LEDs/each optic 1
Light colour White
Required components:
F17437_HEKLA-G2-H

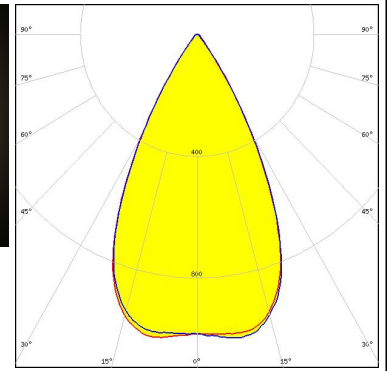

NICHIA

LED COB L-Type (LES 11)
Ordering code CP18764_YASMEEN-70-WW-C2
FWHM / FWTM 54.0° / 75.0°
Efficiency 80 %
Peak intensity 1 cd/lm
LEDs/each optic 1
Light colour White
Required components:
F17437_HEKLA-G2-H

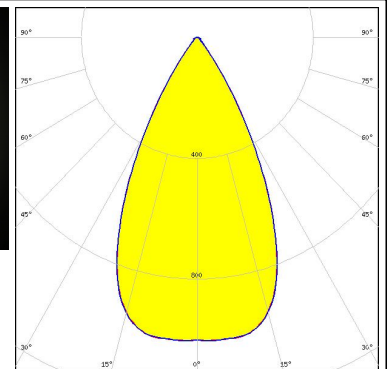
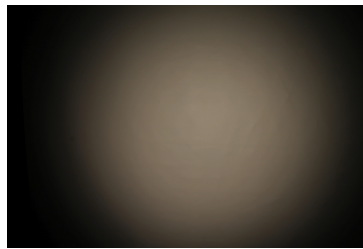

NICHIA

LED COB S-Type (LES 7)
Ordering code CP18764_YASMEEN-70-WW-C2
FWHM / FWTM 53.0° / 76.0°
Efficiency 80 %
Peak intensity 1 cd/lm
LEDs/each optic 1
Light colour White
Required components:
F17438_HEKLA-G2-I

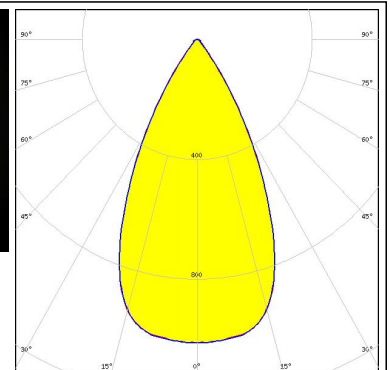
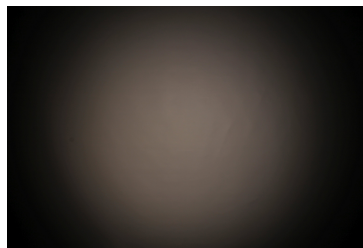

OPTICAL RESULTS (MEASURED):

PHILIPS

LED Fortimo SLM L09 CoB
Ordering code CP18778_YASMEEN-70-WW-C2-WHT
FWHM / FWTM 54.0° / 76.0°
Efficiency 90 %
Peak intensity 1 cd/lm
LEDs/each optic 1
Light colour White
Required components:
F17437_HEKLA-G2-H

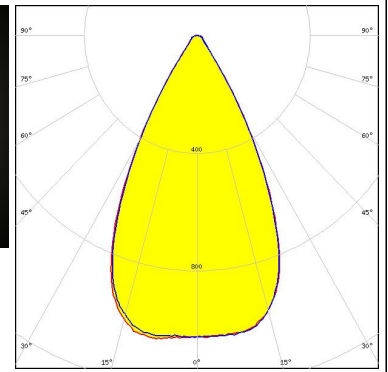
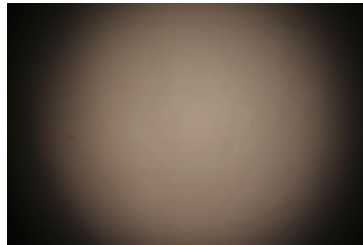

PHILIPS

LED Fortimo SLM L09 CoB
Ordering code CP18764_YASMEEN-70-WW-C2
FWHM / FWTM 54.0° / 74.0°
Efficiency 81 %
Peak intensity 1 cd/lm
LEDs/each optic 1
Light colour White
Required components:
F17437_HEKLA-G2-H

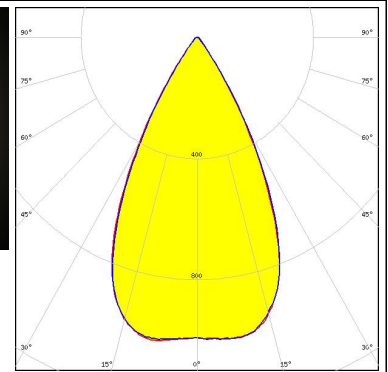
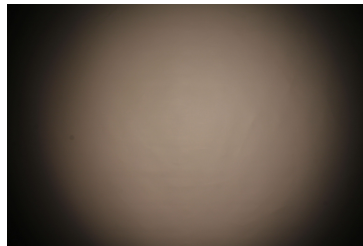

SAMSUNG

LED LC016D / LC019D / LC026D / LC033D
Ordering code CP18764_YASMEEN-70-WW-C2
FWHM / FWTM 52.0° / 77.0°
Efficiency 80 %
Peak intensity 1 cd/lm
LEDs/each optic 1
Light colour White
Required components:
F17438_HEKLA-G2-I

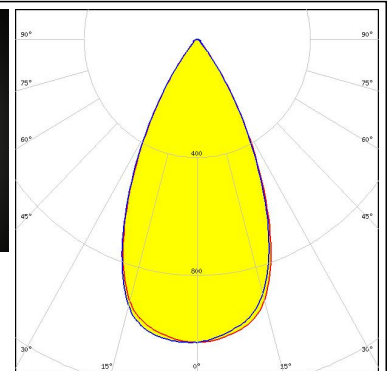
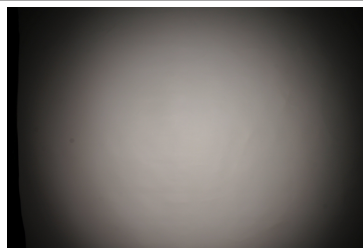

SAMSUNG

LED LC016D / LC019D / LC026D / LC033D
Ordering code CP18778_YASMEEN-70-WW-C2-WHT
FWHM / FWTM 52.0° / 79.0°
Efficiency 89 %
Peak intensity 1.1 cd/lm
LEDs/each optic 1
Light colour White
Required components:
F17438_HEKLA-G2-I

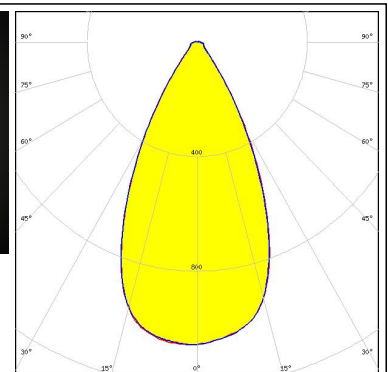
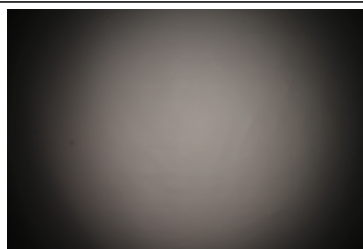

OPTICAL RESULTS (MEASURED):

SAMSUNG

LED LC030C/040C G2
 Ordering code CP18778_YASMEEN-70-WW-C2-WHT
 FWHM / FWTM 54.0° / 78.0°
 Efficiency 90 %
 Peak intensity 1 cd/lm
 LEDs/each optic 1
 Light colour White
 Required components:
 F17438_HEKLA-G2-I

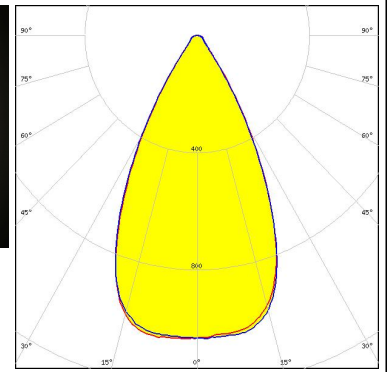

SAMSUNG

LED LC030C/040C G2
 Ordering code CP18764_YASMEEN-70-WW-C2
 FWHM / FWTM 54.0° / 75.0°
 Efficiency 81 %
 Peak intensity 1 cd/lm
 LEDs/each optic 1
 Light colour White
 Required components:
 F17438_HEKLA-G2-I

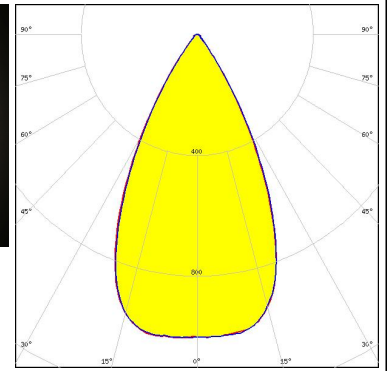

SEOUL SEMICONDUCTOR
 LED MJT COB LES 14.5
 Ordering code CP18778_YASMEEN-70-WW-C2-WHT
 FWHM / FWTM 52.0° / 79.0°
 Efficiency 89 %
 Peak intensity 1.1 cd/lm
 LEDs/each optic 1
 Light colour White
 Required components:
 F17438_HEKLA-G2-I

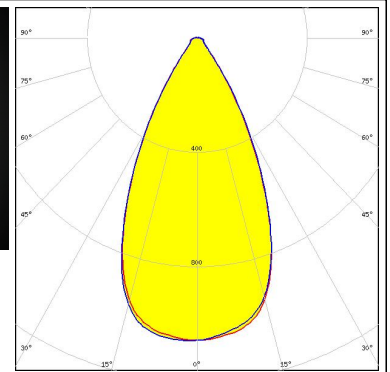

SEOUL SEMICONDUCTOR
 LED MJT COB LES 14.5
 Ordering code CP18764_YASMEEN-70-WW-C2
 FWHM / FWTM 52.0° / 77.0°
 Efficiency 80 %
 Peak intensity 1 cd/lm
 LEDs/each optic 1
 Light colour White
 Required components:
 F17438_HEKLA-G2-I

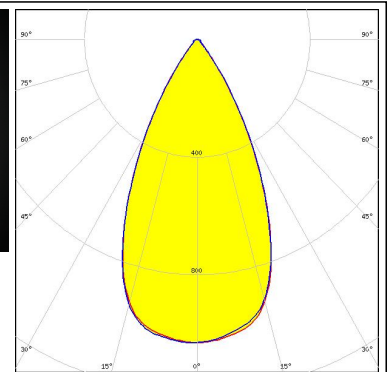
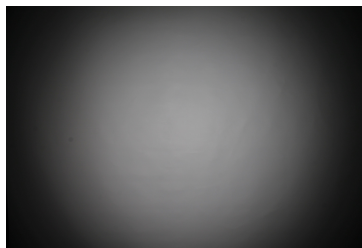

OPTICAL RESULTS (MEASURED):

TRIDONIC

LED SLE G7 LES13
Ordering code CP18778_YASMEEN-70-WW-C2-WHT
FWHM / FWTM 53.0° / 78.0°
Efficiency 90 %
Peak intensity 1 cd/lm
LEDs/each optic 1
Light colour White
Required components:
F17438_HEKLA-G2-I

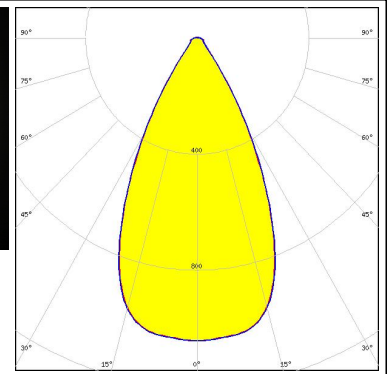
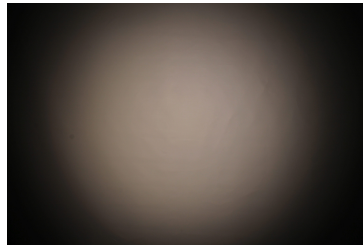

TRIDONIC

LED SLE G7 LES15
Ordering code CP18764_YASMEEN-70-WW-C2
FWHM / FWTM 52.0° / 76.0°
Efficiency 80 %
Peak intensity 1 cd/lm
LEDs/each optic 1
Light colour White
Required components:
F17438_HEKLA-G2-I

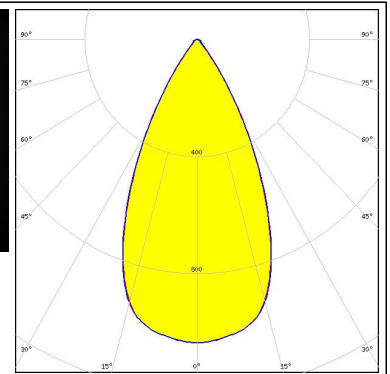
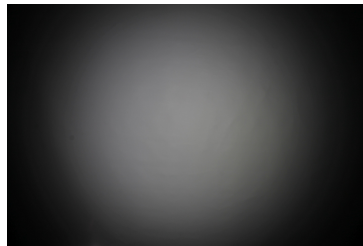

TRIDONIC

LED SLE G7 LES15
Ordering code CP18778_YASMEEN-70-WW-C2-WHT
FWHM / FWTM 52.0° / 78.0°
Efficiency 90 %
Peak intensity 1.1 cd/lm
LEDs/each optic 1
Light colour White
Required components:
F17438_HEKLA-G2-I

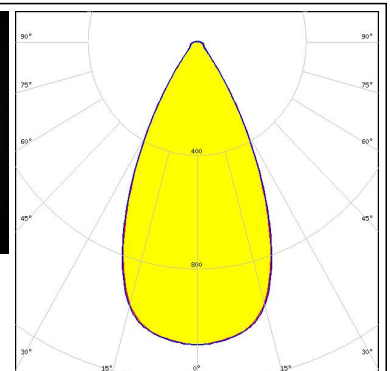
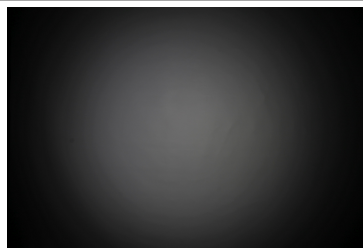

OPTICAL RESULTS (SIMULATED):



LED V6 HD Gen 7
Ordering code CP18764_YASMEEN-70-WW-C2
FWHM / FWTM 58.0° / 76.0°
Efficiency 83 %
Peak intensity 1 cd/lm
LEDs/each optic 1
Light colour White
Required components:
 F15255_HEKLA-SOCKET-C

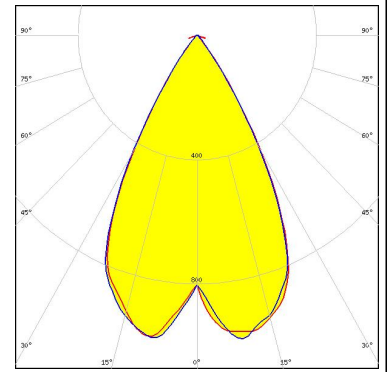

CITIZEN

LED CLL03x/CLU03x
Ordering code CP18771_YASMEEN-70-WW-B2
FWHM / FWTM 54.0° / 78.0°
Efficiency 79 %
Peak intensity 1 cd/lm
LEDs/each optic 1
Light colour White
Required components:
 BJB: 47.360.1010

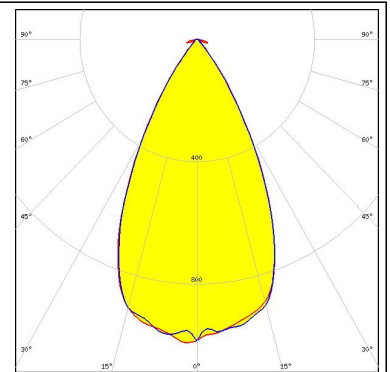

CITIZEN

LED CLL03x/CLU03x
Ordering code CP18785_YASMEEN-70-WW-B2-WHT
FWHM / FWTM 54.0° / 80.0°
Efficiency 89 %
Peak intensity 1 cd/lm
LEDs/each optic 1
Light colour White
Required components:
 BJB: 47.360.1010

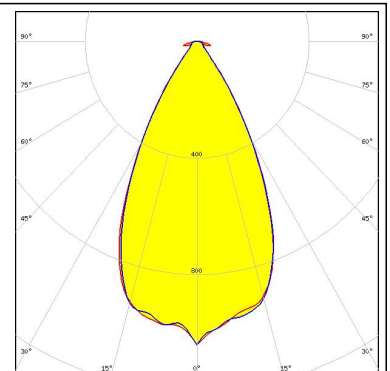

CITIZEN

LED CLU712/713
Ordering code CP18764_YASMEEN-70-WW-C2
FWHM / FWTM 56.0° / 76.0°
Efficiency 81 %
Peak intensity 1 cd/lm
LEDs/each optic 1
Light colour White
Required components:
 F17438_HEKLA-G2-I

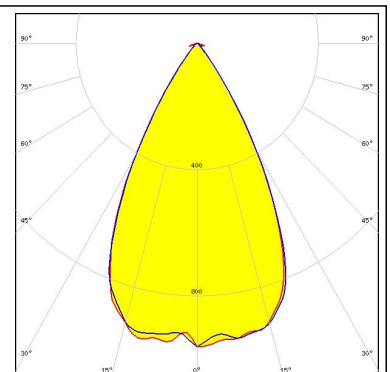

OPTICAL RESULTS (SIMULATED):

CITIZEN

LED CLU712/713
 Ordering code C17241_YASMEEN-70-WW
 FWHM / FWTM 57.0° / 76.0°
 Efficiency 92 %
 Peak intensity 1 cd/lm
 LEDs/each optic 1
 Light colour White
 Required components:

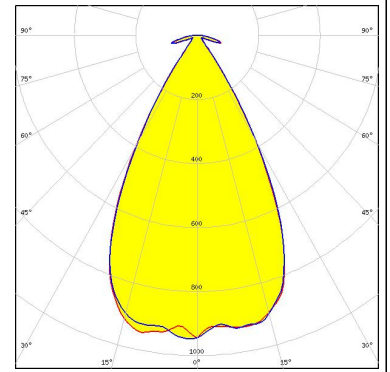

CITIZEN

LED CLU712/713
 Ordering code CP18778_YASMEEN-70-WW-C2-WHT
 FWHM / FWTM 58.0° / 78.0°
 Efficiency 90 %
 Peak intensity 1 cd/lm
 LEDs/each optic 1
 Light colour White
 Required components:
 F17438_HEKLA-G2-I

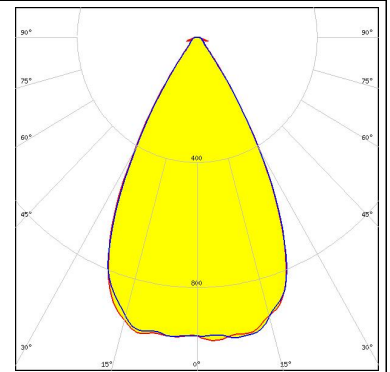

CREE LED

LED CMU10xx
 Ordering code CP18764_YASMEEN-70-WW-C2
 FWHM / FWTM 56.0° / 76.0°
 Efficiency 81 %
 Peak intensity 1 cd/lm
 LEDs/each optic 1
 Light colour White
 Required components:
 F17435_HEKLA-G2-C

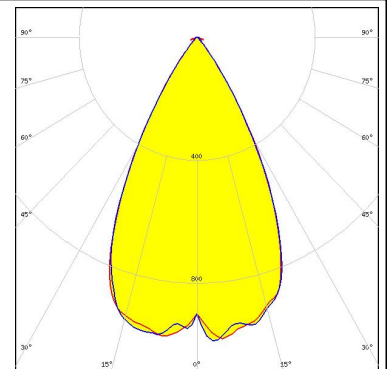

CREE LED

LED CXA/B 13xx
 Ordering code CP18764_YASMEEN-70-WW-C2
 FWHM / FWTM 58.0° / 76.0°
 Efficiency 82 %
 Peak intensity 1 cd/lm
 LEDs/each optic 1
 Light colour White
 Required components:
 F17439_HEKLA-G2-J

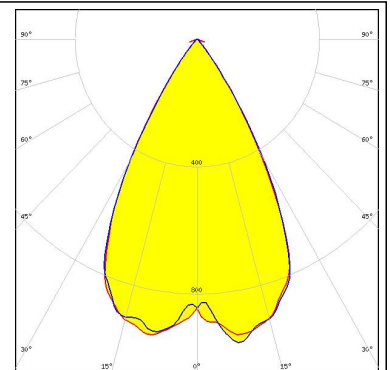

OPTICAL RESULTS (SIMULATED):



LED CXA/B 15xx
 Ordering code CP18764_YASMEEN-70-WW-C2
 FWHM / FWTM 56.0° / 76.0°
 Efficiency 80 %
 Peak intensity 1 cd/lm
 LEDs/each optic 1
 Light colour White
 Required components:
 F17436_HEKLA-G2-D

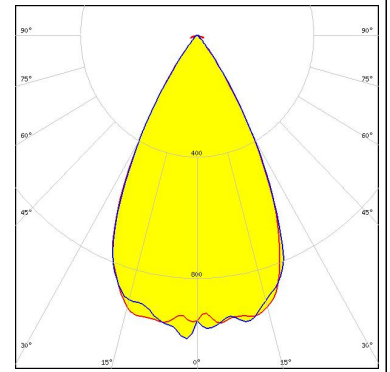

LED CXA/B 1830
 Ordering code CP18764_YASMEEN-70-WW-C2
 FWHM / FWTM 54.0° / 78.0°
 Efficiency 79 %
 Peak intensity 1 cd/lm
 LEDs/each optic 1
 Light colour White
 Required components:
 Bender Wirth: 637b Hekla

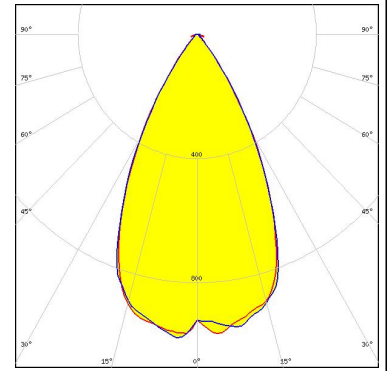

LED CxM-14 (19x19)
 Ordering code CP18764_YASMEEN-70-WW-C2
 FWHM / FWTM 54.0° / 78.0°
 Efficiency 78 %
 Peak intensity 1 cd/lm
 LEDs/each optic 1
 Light colour White
 Required components:
 F17438_HEKLA-G2-I

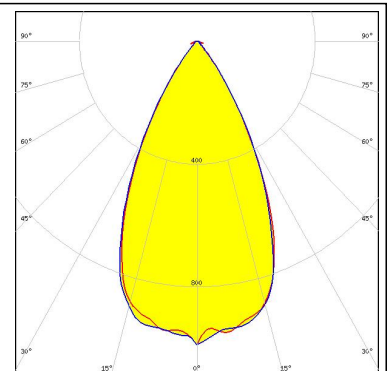

LED NVCWJ024Z-V1MT: COB J-Type Tunable White
 Ordering code CP18764_YASMEEN-70-WW-C2
 FWHM / FWTM 58.0° / 80.0°
 Efficiency 81 %
 Peak intensity 0.9 cd/lm
 LEDs/each optic 1
 Light colour White
 Required components:
 C16142_HEKLA-SOCKET-K
 Bender Wirth: 498 Typ L8 HV

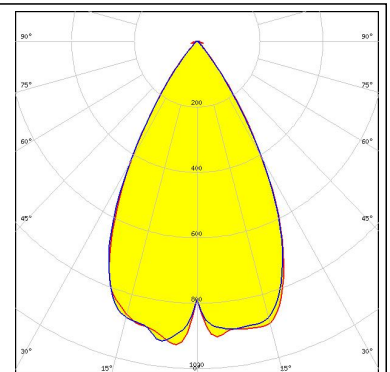

OPTICAL RESULTS (SIMULATED):

OSRAM

LED PrevaLED Core G7 LES15 CoB
Ordering code CP18764_YASMEEN-70-WW-C2
FWHM / FWTM 52.0° / 78.0°
Efficiency 78 %
Peak intensity 1 cd/lm
LEDs/each optic 1
Light colour White
Required components:
F17438_HEKLA-G2-I

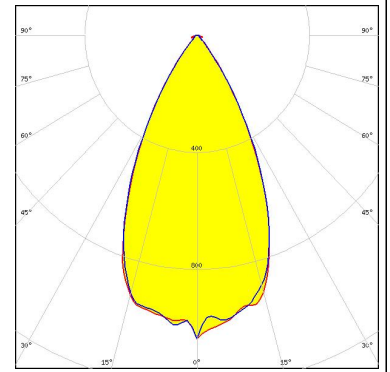

SAMSUNG

LED LC003D / LC006D / LC009D / LC013D
Ordering code CP18764_YASMEEN-70-WW-C2
FWHM / FWTM 56.0° / 76.0°
Efficiency 80 %
Peak intensity 1 cd/lm
LEDs/each optic 1
Light colour White
Required components:
F17435_HEKLA-G2-C

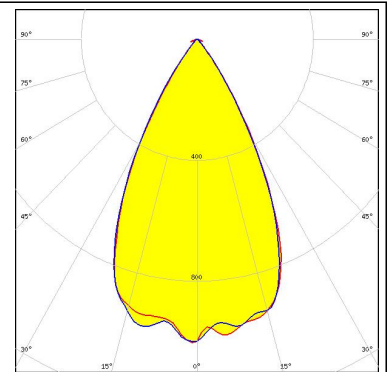

SAMSUNG

LED LC020T (Tunable white)
Ordering code C17241_YASMEEN-70-WW
FWHM / FWTM 59.0° / 80.0°
Efficiency 81 %
Peak intensity 0.9 cd/lm
LEDs/each optic 1
Light colour White
Required components:

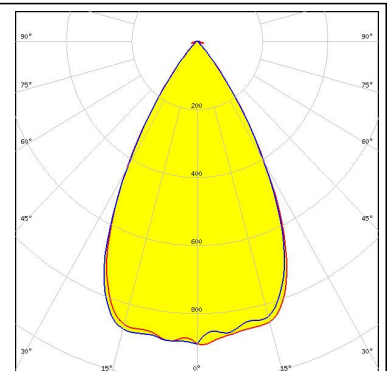

SAMSUNG

LED LC035T (Tunable white)
Ordering code C17241_YASMEEN-70-WW
FWHM / FWTM 54.0° / 82.0°
Efficiency 75 %
Peak intensity 0.9 cd/lm
LEDs/each optic 1
Light colour White
Required components:

