

### YASMEEN-70-S

~15° spot beam. Assembly with holder C (LEDiL HEKLA) and B (BJB and B+W). Black and white versions.

#### SPECIFICATION:

Dimensions	Ø 70.0 mm
Height	37.7 mm
Fastening	socket
ROHS compliant	yes ⓘ



#### MATERIALS:

Component	Type	Material	Colour	Finish
YASMEEN-70-S	Single lens	PMMA	clear	
YASMEEN-70-HLD2-C	Holder C	PC	black	
YASMEEN-70-HLD2-B	Holder B	PC	black	
YASMEEN-70-HLD2-C-WHT	Holder C	PC	white	
YASMEEN-70-HLD2-B-WHT	Holder B	PC	white	

### ORDERING INFORMATION:

Component	Qty in box	MOQ	MPQ	Box weight (kg)
C17238_YASMEEN-70-S	105	105	15	8.0
<b>Assembly</b>				
CP18782_YASMEEN-70-S-B2-WHT	105	105	15	9.5
CP18775_YASMEEN-70-S-C2-WHT	105	105	15	9.4
CP18768_YASMEEN-70-S-B2	105	105	15	9.5
CP18751_YASMEEN-70-S-C2	105	105	15	9.4

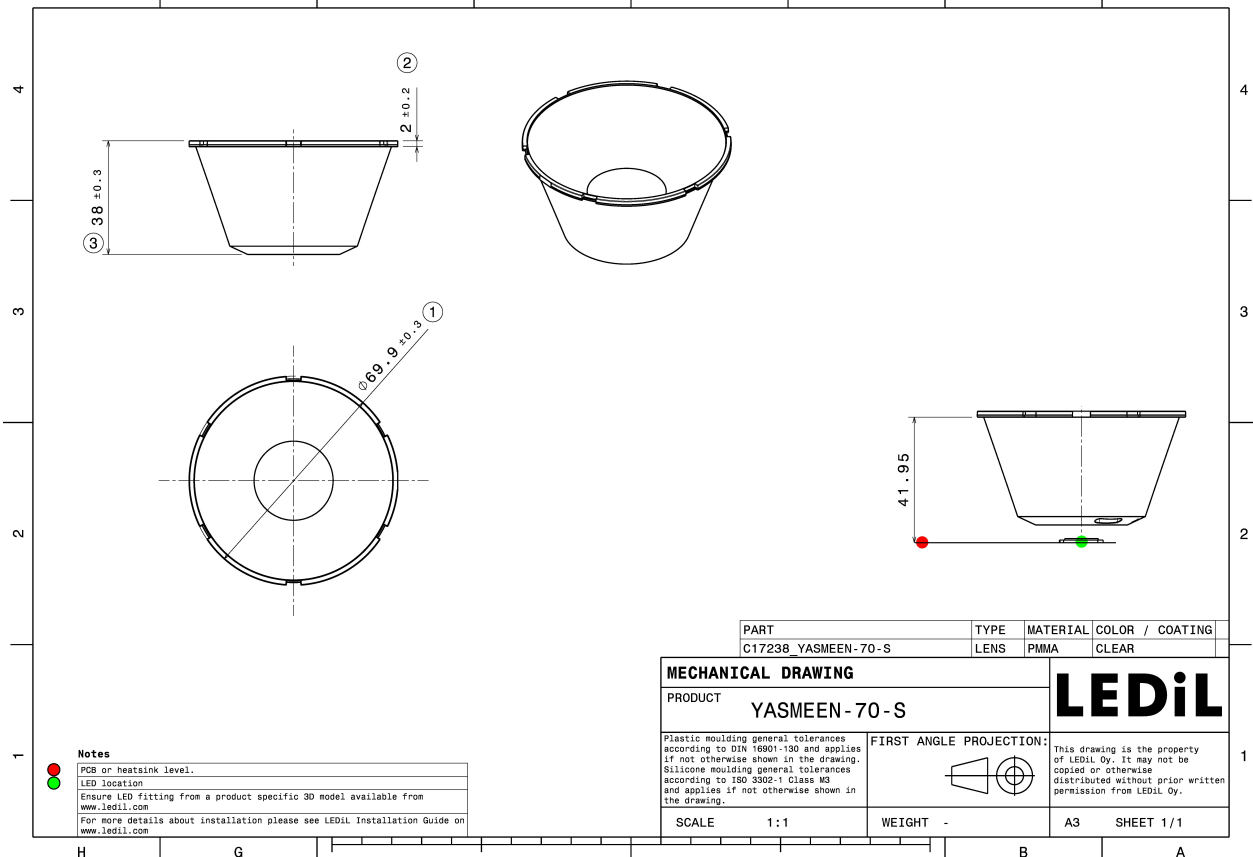
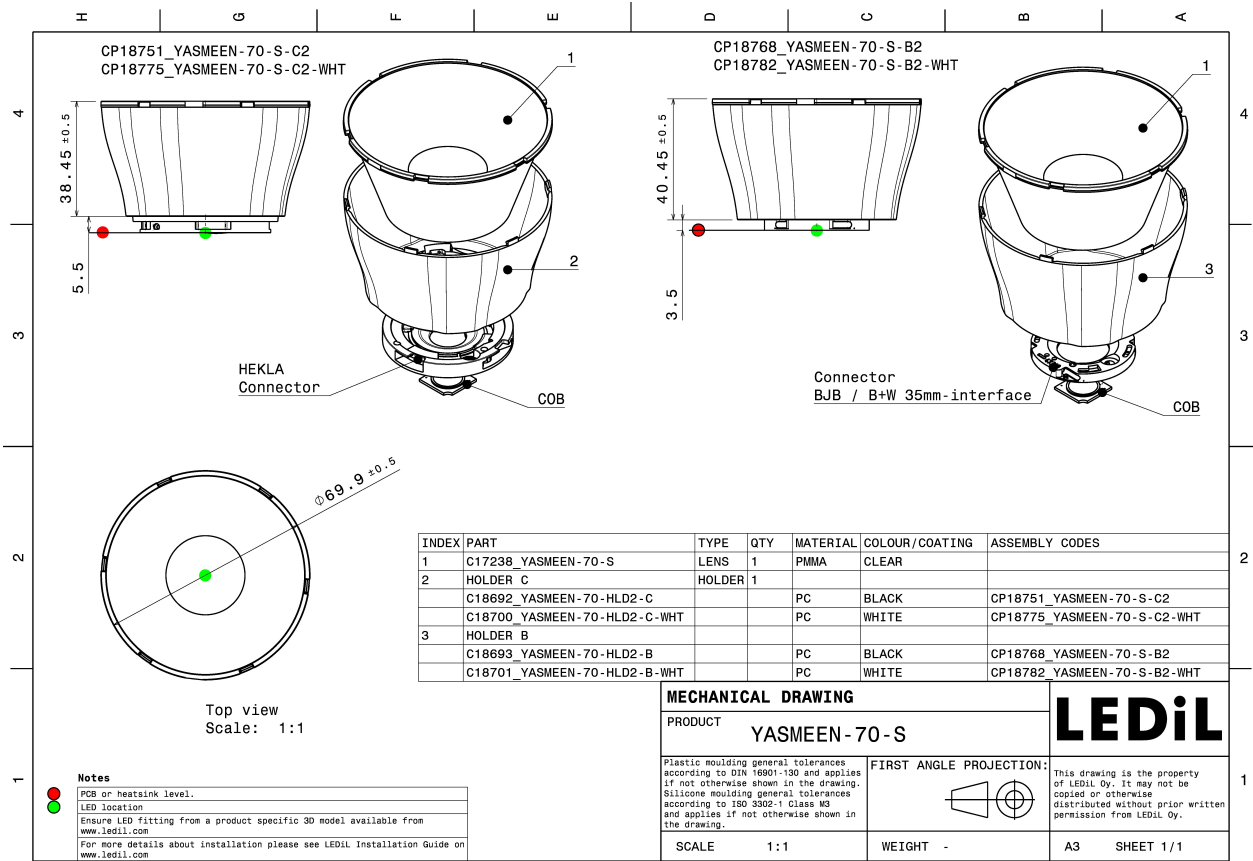

See also our general installation guide: [www.ledil.com/installation\\_guide](http://www.ledil.com/installation_guide)

### OPTICAL RESULTS (MEASURED):

bridgelux

LED V10 Gen 8  
 Ordering code CP18751\_YASMEEN-70-S-C2  
 FWHM / FWTM 16.0° / 27.0°  
 Efficiency 88 %  
 Peak intensity 9.5 cd/m  
 LEDs/each optic 1  
 Light colour White  
 Required components:  
 F15255\_HEKLA-SOCKET-C

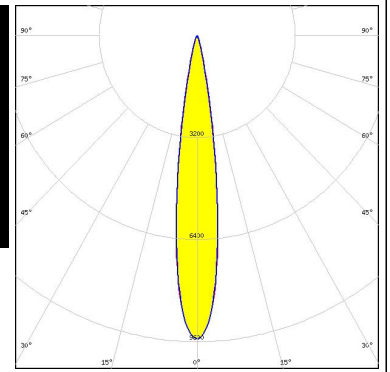

bridgelux

LED V11 HD Gen 8  
 Ordering code CP18751\_YASMEEN-70-S-C2  
 FWHM / FWTM 18.0° / 30.0°  
 Efficiency 87 %  
 Peak intensity 8 cd/m  
 LEDs/each optic 1  
 Light colour White  
 Required components:  
 Bender Wirth: 633d Hekla

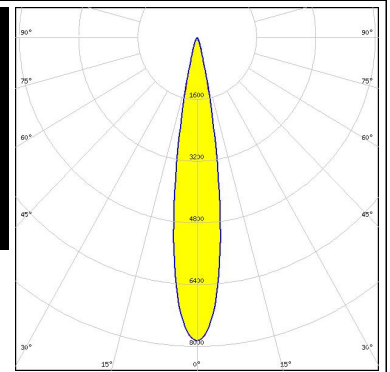

bridgelux

LED V11 HD Gen 8  
 Ordering code CP18775\_YASMEEN-70-S-C2-WHT  
 FWHM / FWTM 18.0° / 30.0°  
 Efficiency 93 %  
 Peak intensity 8 cd/m  
 LEDs/each optic 1  
 Light colour White  
 Required components:  
 Bender Wirth: 633d Hekla

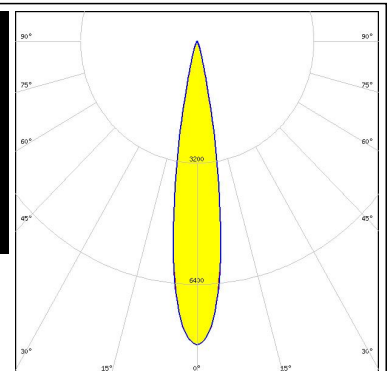
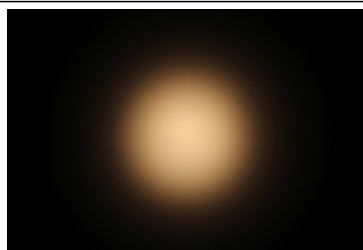

bridgelux

LED V13 Gen 8  
 Ordering code CP18751\_YASMEEN-70-S-C2  
 FWHM / FWTM 23.0° / 39.0°  
 Efficiency 86 %  
 Peak intensity 4.8 cd/m  
 LEDs/each optic 1  
 Light colour White  
 Required components:  
 F15859\_HEKLA-SOCKET-I

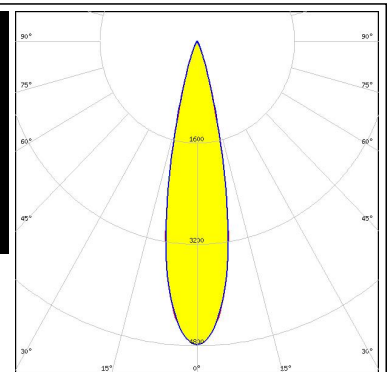
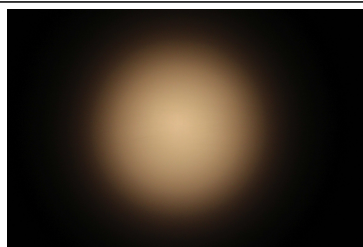

### OPTICAL RESULTS (MEASURED):

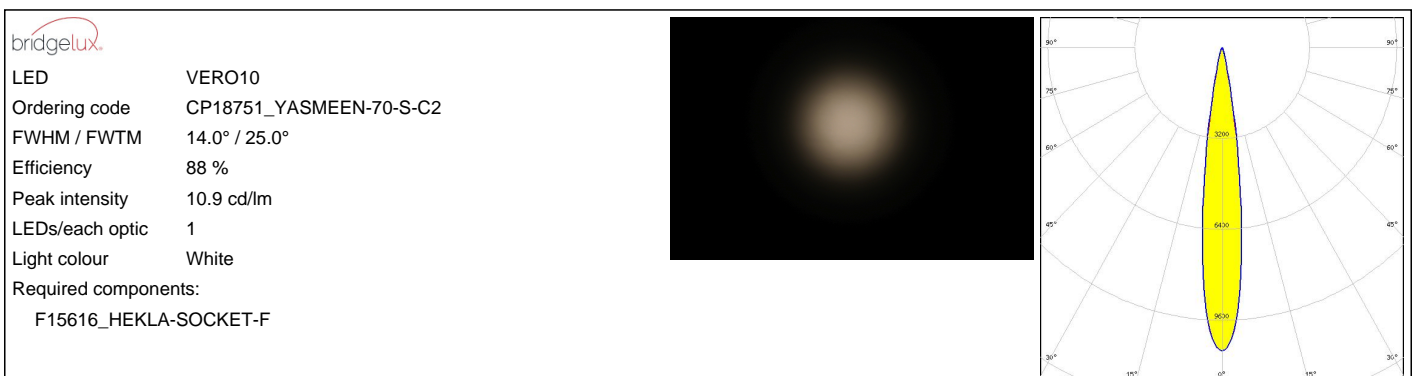
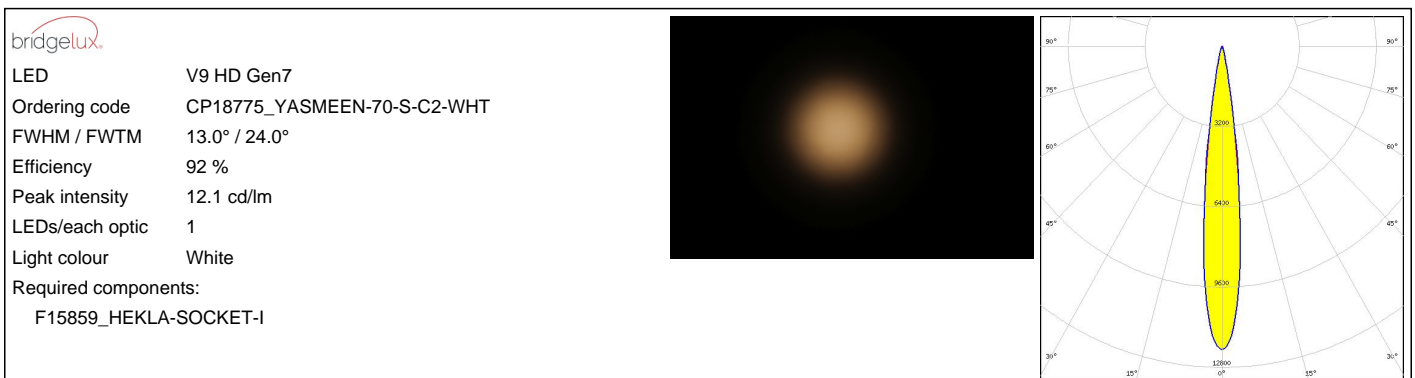
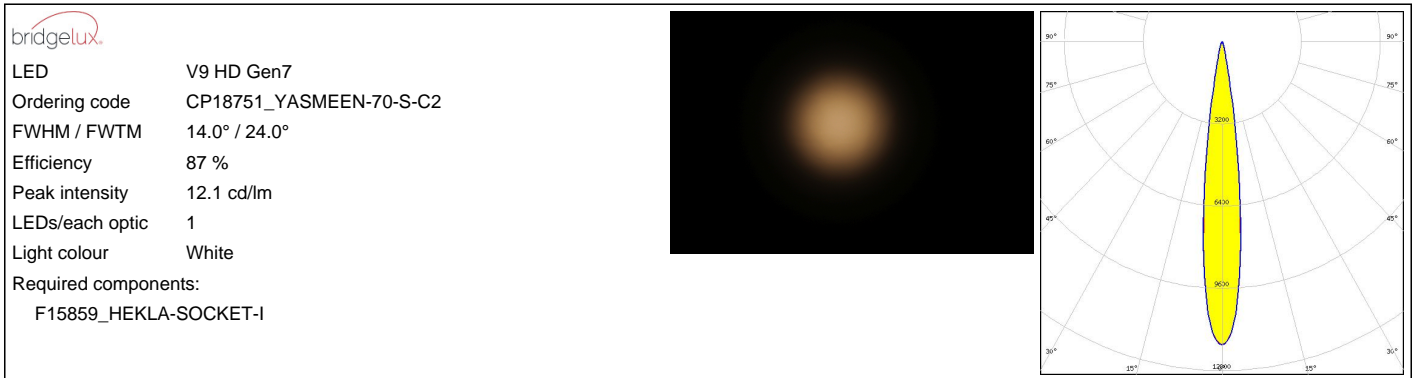
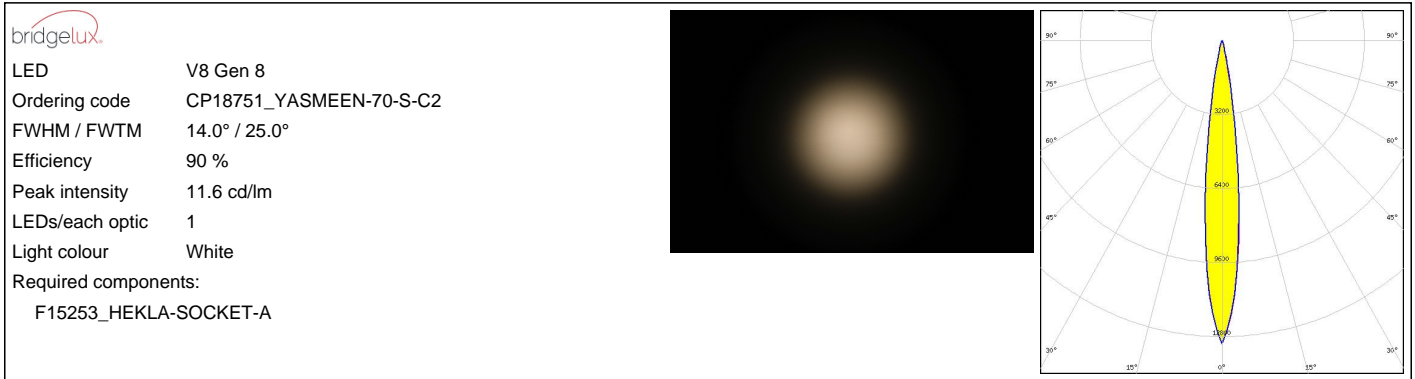

### OPTICAL RESULTS (MEASURED):

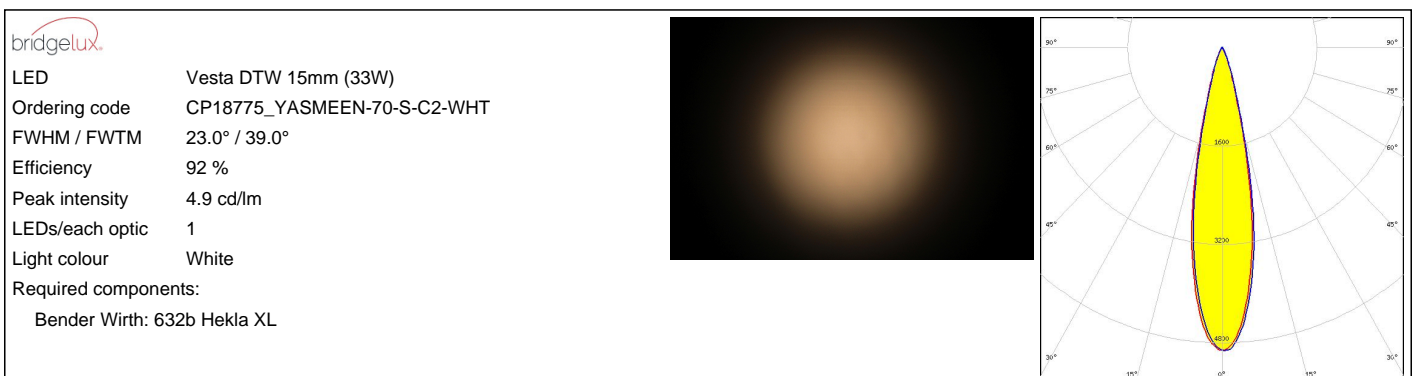
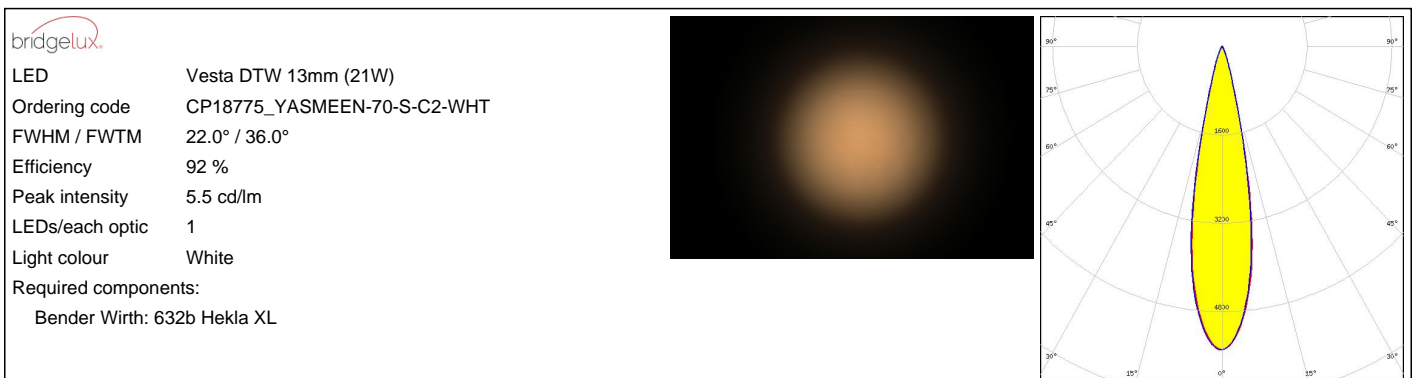
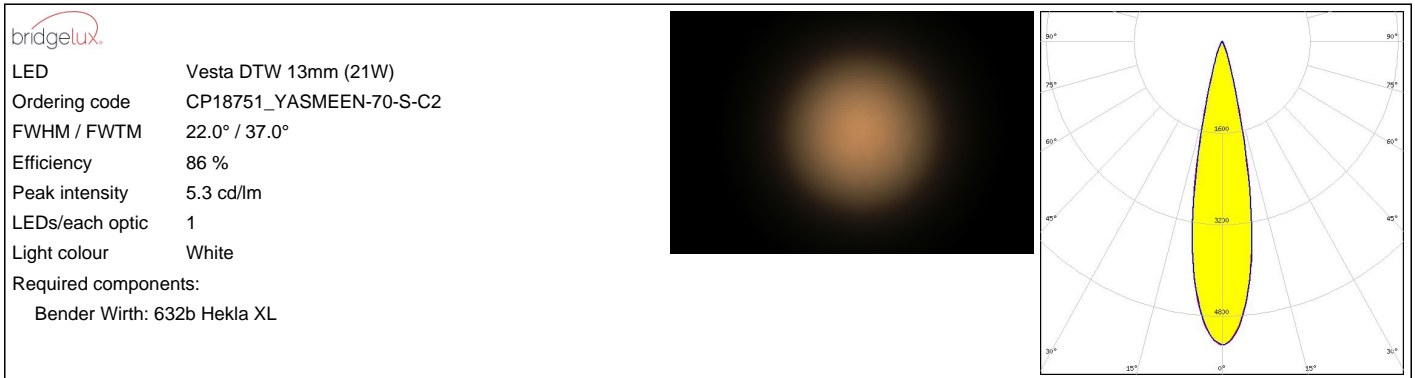
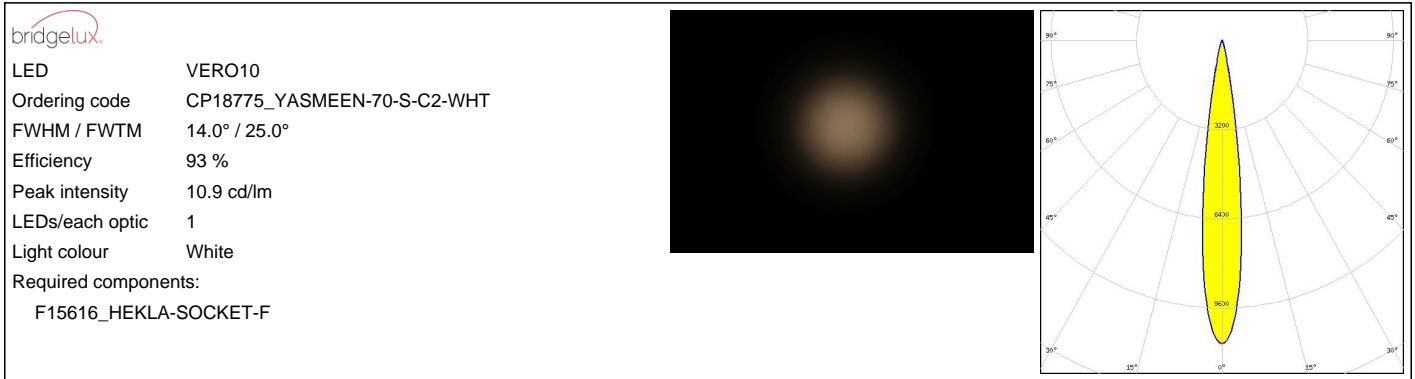

### OPTICAL RESULTS (MEASURED):

bridgelux.

LED Vesta DTW 15mm (33W)  
 Ordering code CP18751\_YASMEEN-70-S-C2  
 FWHM / FWTM 23.0° / 39.0°  
 Efficiency 86 %  
 Peak intensity 4.9 cd/lm  
 LEDs/each optic 1  
 Light colour White  
 Required components:  
 Bender Wirth: 632b Hekla XL

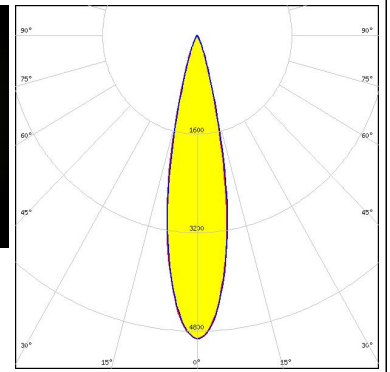

bridgelux.

LED Vesta DTW 9mm (4W/6W/12W)  
 Ordering code CP18775\_YASMEEN-70-S-C2-WHT  
 FWHM / FWTM 15.0° / 25.0°  
 Efficiency 93 %  
 Peak intensity 11 cd/lm  
 LEDs/each optic 1  
 Light colour White  
 Required components:  
 Bender Wirth: 652b Hekla

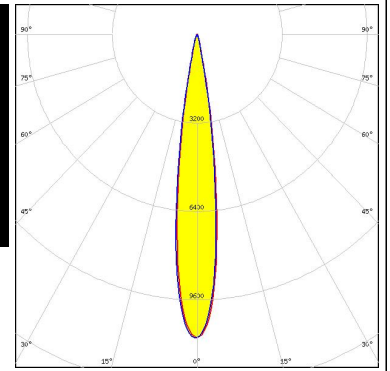
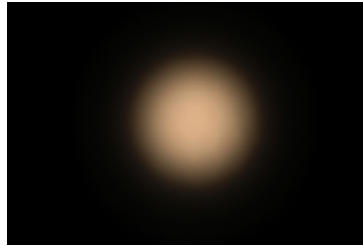

bridgelux.

LED Vesta DTW 9mm (4W/6W/12W)  
 Ordering code CP18751\_YASMEEN-70-S-C2  
 FWHM / FWTM 15.0° / 26.0°  
 Efficiency 88 %  
 Peak intensity 10.6 cd/lm  
 LEDs/each optic 1  
 Light colour White  
 Required components:  
 Bender Wirth: 652b Hekla

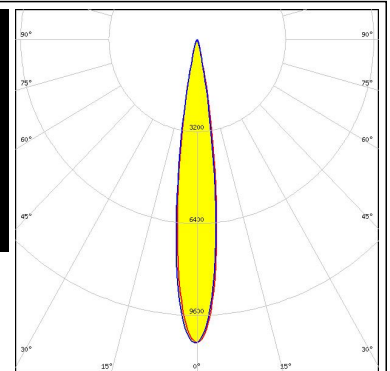

### CITIZEN

LED CLL02x/CLU02x (LES10)  
 Ordering code CP18751\_YASMEEN-70-S-C2  
 FWHM / FWTM 15.5° / 26.5 + 27.0°  
 Efficiency 87 %  
 Peak intensity 10 cd/lm  
 LEDs/each optic 1  
 Light colour White  
 Required components:  
 F17435\_HEKLA-G2-C

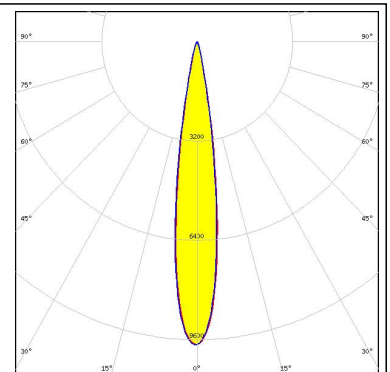

### OPTICAL RESULTS (MEASURED):

#### CITIZEN

LED CLL02x/CLU02x (LES10)  
 Ordering code CP18775\_YASMEEN-70-S-C2-WHT  
 FWHM / FWTM 15.5° / 26.5°  
 Efficiency 92 %  
 Peak intensity 10 cd/lm  
 LEDs/each optic 1  
 Light colour White  
 Required components:  
 F17435\_HEKLA-G2-C

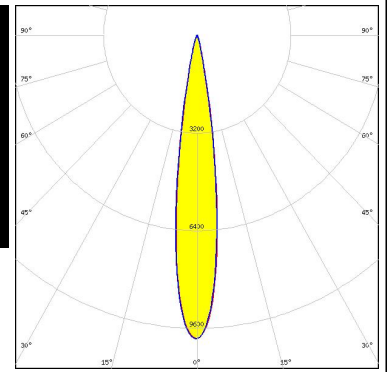
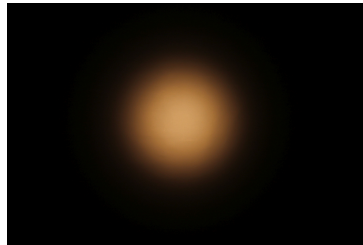

#### CITIZEN

LED CLL02x/CLU02x (LES10)  
 Ordering code CP18751\_YASMEEN-70-S-C2  
 FWHM / FWTM 15.0° / 27.0°  
 Efficiency 87 %  
 Peak intensity 9.8 cd/lm  
 LEDs/each optic 1  
 Light colour White  
 Required components:  
 F17435\_HEKLA-G2-C

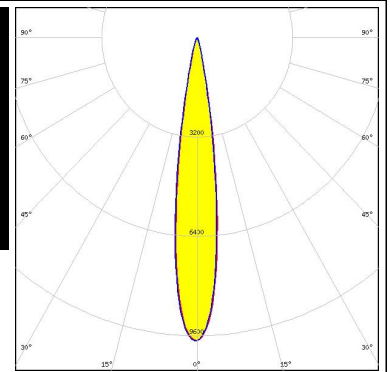
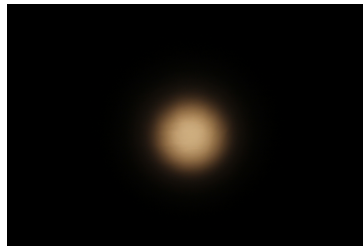

#### CITIZEN

LED CLL03x/CLU03x  
 Ordering code CP18751\_YASMEEN-70-S-C2  
 FWHM / FWTM 21.0° / 36.5°  
 Efficiency 85 %  
 Peak intensity 5.5 cd/lm  
 LEDs/each optic 1  
 Light colour White  
 Required components:  
 F17438\_HEKLA-G2-I

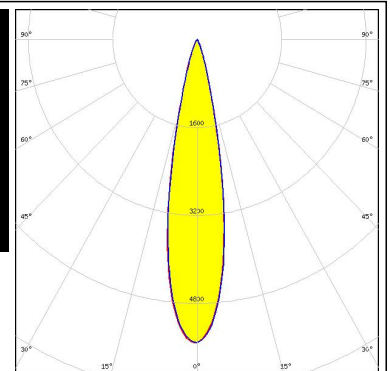
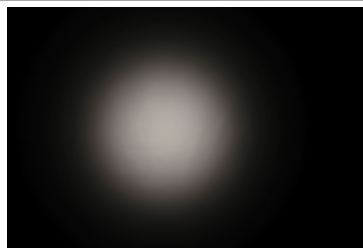

#### CITIZEN

LED CLL03x/CLU03x  
 Ordering code CP18775\_YASMEEN-70-S-C2-WHT  
 FWHM / FWTM 21.0° / 37.0°  
 Efficiency 92 %  
 Peak intensity 5.6 cd/lm  
 LEDs/each optic 1  
 Light colour White  
 Required components:  
 F17438\_HEKLA-G2-I

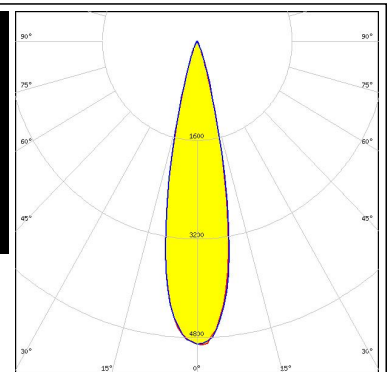



### OPTICAL RESULTS (MEASURED):

#### CITIZEN

LED CLL03x/CLU03x  
 Ordering code CP18768\_YASMEEN-70-S-B2  
 FWHM / FWTM 21.0° / 37.0°  
 Efficiency 86 %  
 Peak intensity 5.6 cd/lm  
 LEDs/each optic 1  
 Light colour White  
 Required components:  
 BJB: 47.360.1010

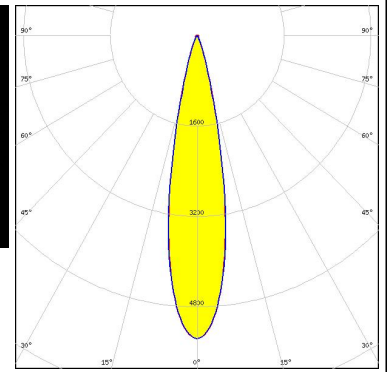
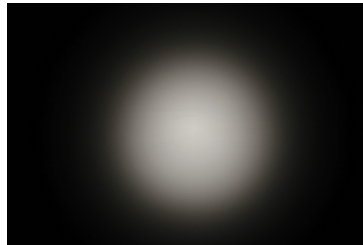

#### CREE LED

LED CMA1516  
 Ordering code CP18751\_YASMEEN-70-S-C2  
 FWHM / FWTM 14.0° / 25.0°  
 Efficiency 87 %  
 Peak intensity 10.9 cd/lm  
 LEDs/each optic 1  
 Light colour White  
 Required components:  
 F17436\_HEKLA-G2-D

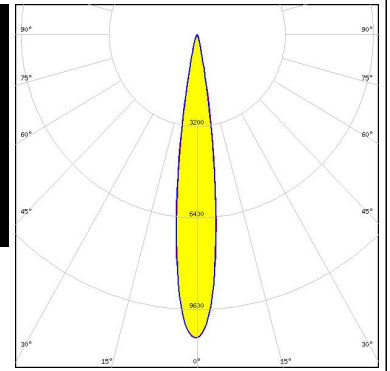
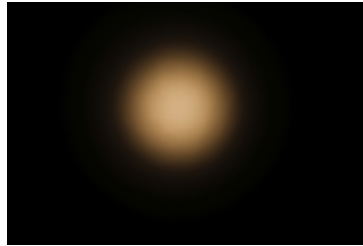

#### CREE LED

LED CMA1516  
 Ordering code CP18775\_YASMEEN-70-S-C2-WHT  
 FWHM / FWTM 14.0° / 25.0°  
 Efficiency 93 %  
 Peak intensity 10.9 cd/lm  
 LEDs/each optic 1  
 Light colour White  
 Required components:  
 F17436\_HEKLA-G2-D

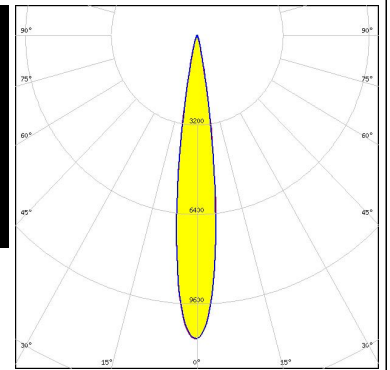
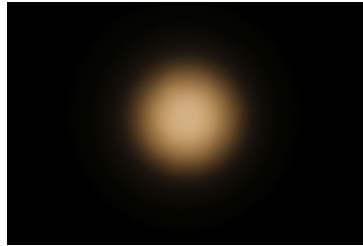

#### CREE LED

LED CMA1825  
 Ordering code CP18775\_YASMEEN-70-S-C2-WHT  
 FWHM / FWTM 19.0° / 32.0°  
 Efficiency 93 %  
 Peak intensity 6.9 cd/lm  
 LEDs/each optic 1  
 Light colour White  
 Required components:  
 F15254\_HEKLA-SOCKET-B

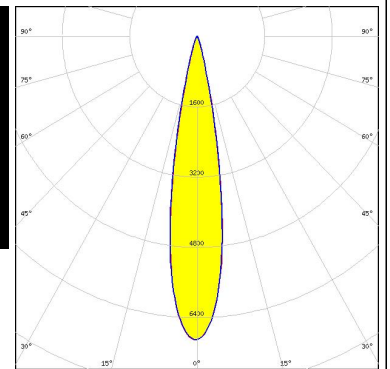

### OPTICAL RESULTS (MEASURED):



**LED** CMA1825  
**Ordering code** CP18751\_YASMEEN-70-S-C2  
**FWHM / FWTM** 19.0° / 32.0°  
**Efficiency** 87 %  
**Peak intensity** 6.9 cd/lm  
**LEDs/each optic** 1  
**Light colour** White  
**Required components:**  
 F15254\_HEKLA-SOCKET-B

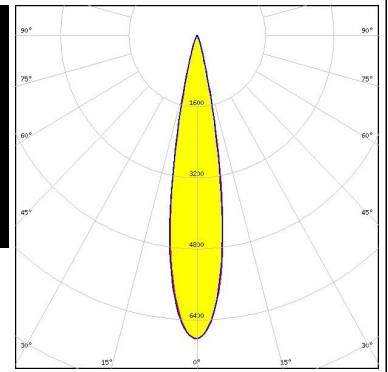

**LED** CMT14xx  
**Ordering code** CP18775\_YASMEEN-70-S-C2-WHT  
**FWHM / FWTM** 15.0° / 26.0°  
**Efficiency** 92 %  
**Peak intensity** 10.1 cd/lm  
**LEDs/each optic** 1  
**Light colour** White  
**Required components:**  
 F17435\_HEKLA-G2-C

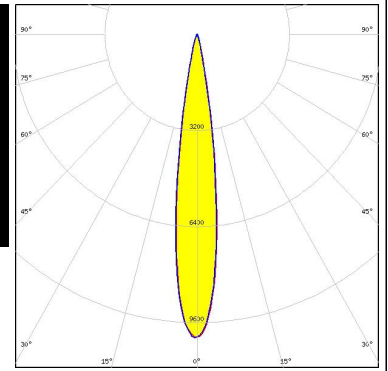

**LED** CMT14xx  
**Ordering code** CP18751\_YASMEEN-70-S-C2  
**FWHM / FWTM** 15.0° / 26.0°  
**Efficiency** 86 %  
**Peak intensity** 10.1 cd/lm  
**LEDs/each optic** 1  
**Light colour** White  
**Required components:**  
 F17435\_HEKLA-G2-C

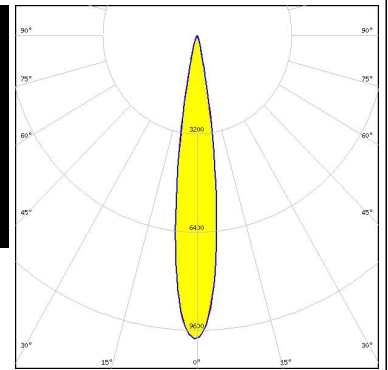
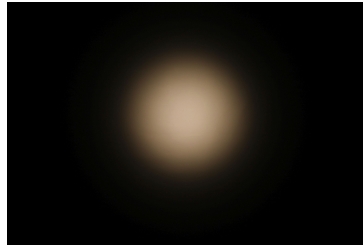

**LED** CMT19xx  
**Ordering code** CP18751\_YASMEEN-70-S-C2  
**FWHM / FWTM** 21.0° / 36.0°  
**Efficiency** 85 %  
**Peak intensity** 5.4 cd/lm  
**LEDs/each optic** 1  
**Light colour** White  
**Required components:**  
 F17438\_HEKLA-G2-I

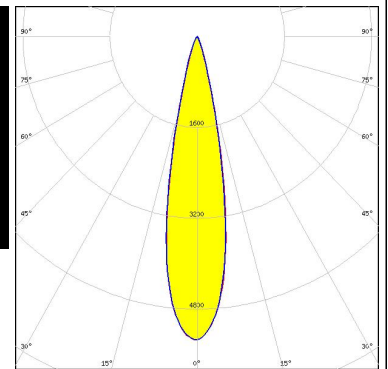

### OPTICAL RESULTS (MEASURED):



**LED** CMT19xx  
**Ordering code** CP18775\_YASMEEN-70-S-C2-WHT  
**FWHM / FWTM** 21.0° / 36.0°  
**Efficiency** 92 %  
**Peak intensity** 5.4 cd/lm  
**LEDs/each optic** 1  
**Light colour** White  
**Required components:**  
 F17438\_HEKLA-G2-I

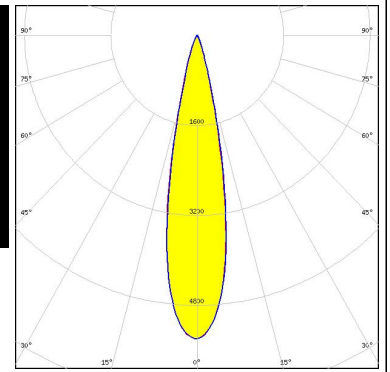

**LED** CMU15xx  
**Ordering code** CP18751\_YASMEEN-70-S-C2  
**FWHM / FWTM** 23.0° / 39.0°  
**Efficiency** 84 %  
**Peak intensity** 4.7 cd/lm  
**LEDs/each optic** 1  
**Light colour** White  
**Required components:**  
 F17438\_HEKLA-G2-I

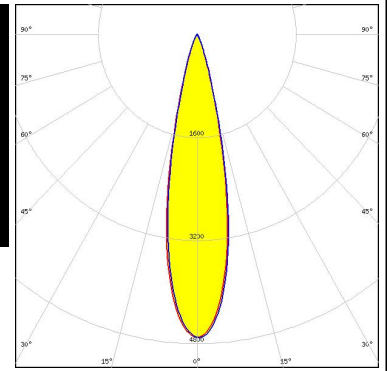

**LED** LUXEON CoB 1202/1203  
**Ordering code** CP18751\_YASMEEN-70-S-C2  
**FWHM / FWTM** 14.0° / 24.0°  
**Efficiency** 86 %  
**Peak intensity** 11.2 cd/lm  
**LEDs/each optic** 1  
**Light colour** White  
**Required components:**  
 F17437\_HEKLA-G2-H

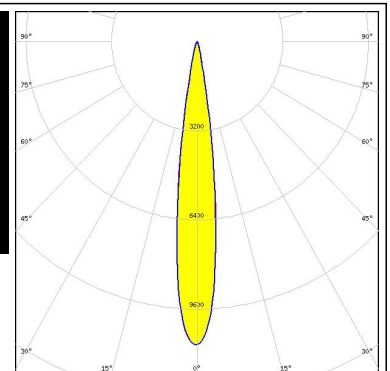

**LED** LUXEON CoB 1202/1203  
**Ordering code** CP18775\_YASMEEN-70-S-C2-WHT  
**FWHM / FWTM** 14.0° / 24.0°  
**Efficiency** 92 %  
**Peak intensity** 11.2 cd/lm  
**LEDs/each optic** 1  
**Light colour** White  
**Required components:**  
 F17437\_HEKLA-G2-H

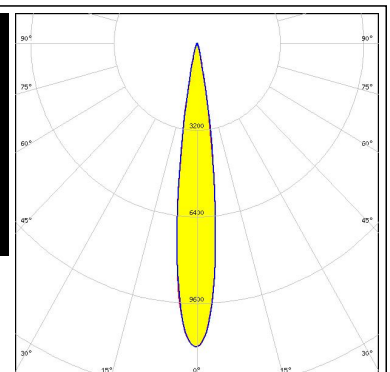
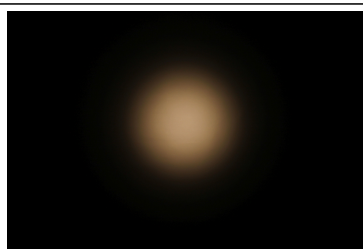

### OPTICAL RESULTS (MEASURED):



**LED** COB L-Type (LES 11)  
**Ordering code** CP18751\_YASMEEN-70-S-C2  
**FWHM / FWTM** 17.0° / 30.0°  
**Efficiency** 86 %  
**Peak intensity** 7.5 cd/lm  
**LEDs/each optic** 1  
**Light colour** White  
**Required components:**  
 F17437\_HEKLA-G2-H

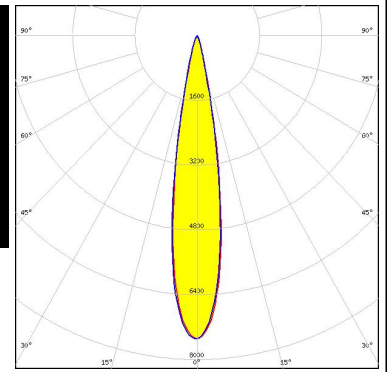

**LED** COB L-Type (LES 9)  
**Ordering code** CP18775\_YASMEEN-70-S-C2-WHT  
**FWHM / FWTM** 13.0° / 24.0°  
**Efficiency** 92 %  
**Peak intensity** 11.9 cd/lm  
**LEDs/each optic** 1  
**Light colour** White  
**Required components:**  
 F17437\_HEKLA-G2-H

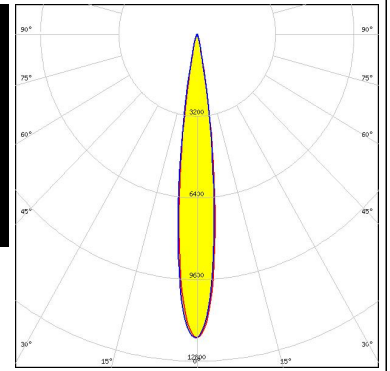
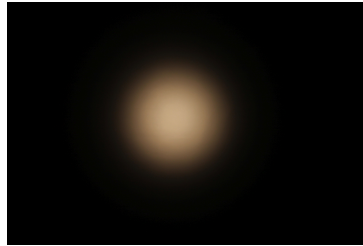

**LED** COB S-Type (LES 7)  
**Ordering code** CP18751\_YASMEEN-70-S-C2  
**FWHM / FWTM** 20.0° / 34.0°  
**Efficiency** 85 %  
**Peak intensity** 6.1 cd/lm  
**LEDs/each optic** 1  
**Light colour** White  
**Required components:**  
 F17438\_HEKLA-G2-I

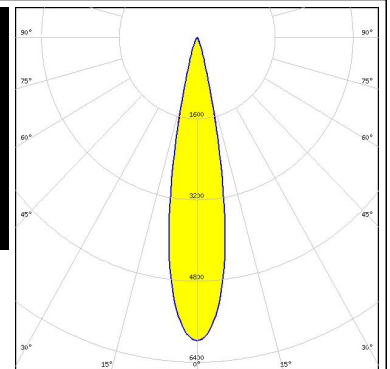
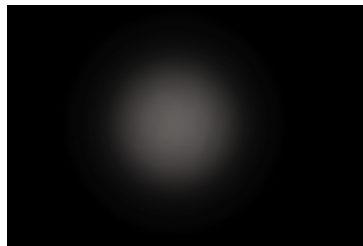

**LED** COB S-Type (LES 7)  
**Ordering code** CP18775\_YASMEEN-70-S-C2-WHT  
**FWHM / FWTM** 20.0° / 34.0°  
**Efficiency** 92 %  
**Peak intensity** 6.1 cd/lm  
**LEDs/each optic** 1  
**Light colour** White  
**Required components:**  
 F17438\_HEKLA-G2-I

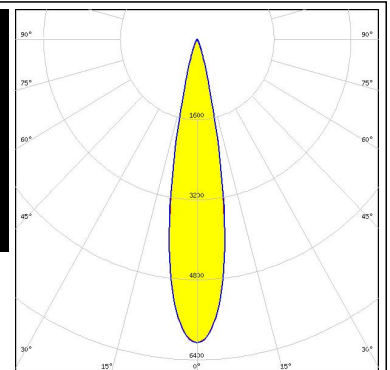

### OPTICAL RESULTS (MEASURED):

#### PHILIPS

LED Fortimo SLM L09 CoB  
 Ordering code CP18751\_YASMEEN-70-S-C2  
 FWHM / FWTM 14.0° / 25.0°  
 Efficiency 86 %  
 Peak intensity 11.1 cd/lm  
 LEDs/each optic 1  
 Light colour White  
 Required components:  
 F17437\_HEKLA-G2-H

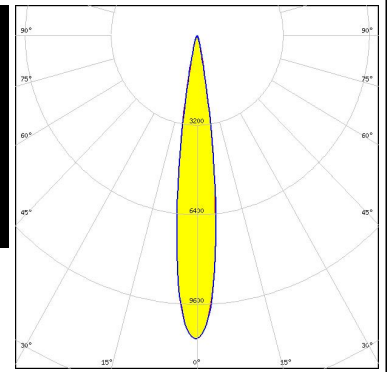

#### PHILIPS

LED Fortimo SLM L09 CoB  
 Ordering code CP18775\_YASMEEN-70-S-C2-WHT  
 FWHM / FWTM 14.0° / 25.0°  
 Efficiency 92 %  
 Peak intensity 11.1 cd/lm  
 LEDs/each optic 1  
 Light colour White  
 Required components:  
 F17437\_HEKLA-G2-H

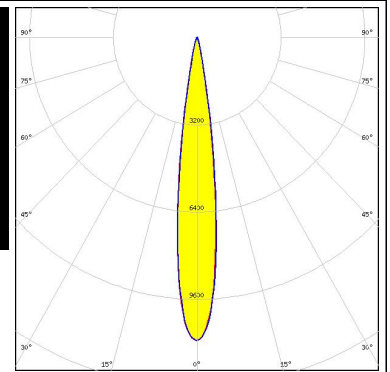

#### SAMSUNG

LED LC016D / LC019D / LC026D / LC033D  
 Ordering code CP18775\_YASMEEN-70-S-C2-WHT  
 FWHM / FWTM 23.0° / 40.0°  
 Efficiency 92 %  
 Peak intensity 4.8 cd/lm  
 LEDs/each optic 1  
 Light colour White  
 Required components:  
 F17438\_HEKLA-G2-I

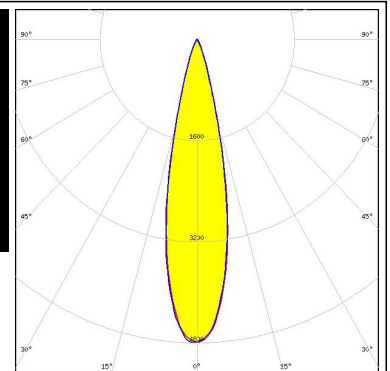
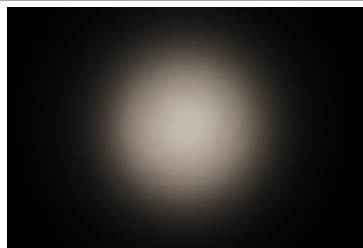

#### SAMSUNG

LED LC016D / LC019D / LC026D / LC033D  
 Ordering code CP18751\_YASMEEN-70-S-C2  
 FWHM / FWTM 23.0° / 39.0°  
 Efficiency 85 %  
 Peak intensity 4.7 cd/lm  
 LEDs/each optic 1  
 Light colour White  
 Required components:  
 F17438\_HEKLA-G2-I

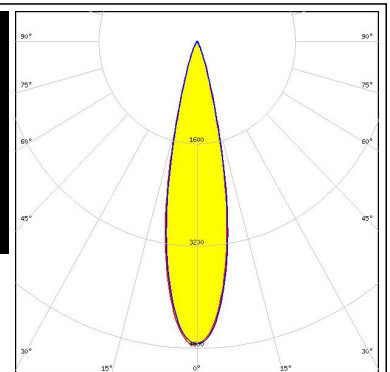
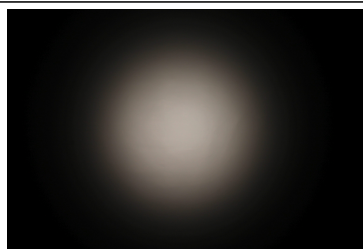

### OPTICAL RESULTS (MEASURED):

#### SAMSUNG

LED LC030C/040C G2  
 Ordering code CP18775\_YASMEEN-70-S-C2-WHT  
 FWHM / FWTM 17.0° / 30.0°  
 Efficiency 92 %  
 Peak intensity 7.7 cd/lm  
 LEDs/each optic 1  
 Light colour White  
 Required components:  
 F17438\_HEKLA-G2-I

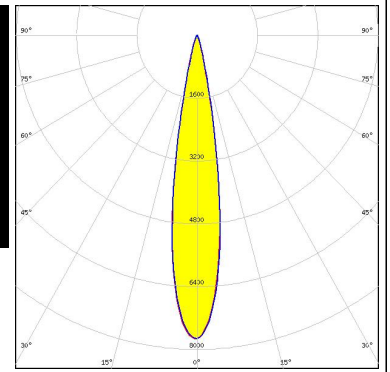

#### SAMSUNG

LED LC030C/040C G2  
 Ordering code CP18751\_YASMEEN-70-S-C2  
 FWHM / FWTM 17.0° / 30.0°  
 Efficiency 86 %  
 Peak intensity 7.7 cd/lm  
 LEDs/each optic 1  
 Light colour White  
 Required components:  
 F17438\_HEKLA-G2-I

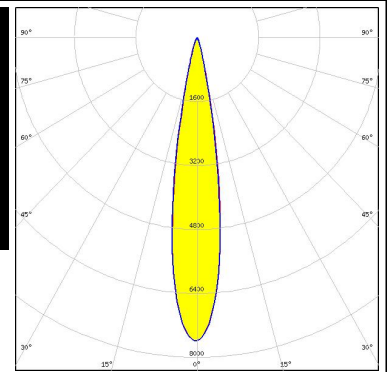

SEOUL SEMICONDUCTOR  
 LED MJT COB LES 14.5  
 Ordering code CP18751\_YASMEEN-70-S-C2  
 FWHM / FWTM 23.0° / 38.0°  
 Efficiency 85 %  
 Peak intensity 4.8 cd/lm  
 LEDs/each optic 1  
 Light colour White  
 Required components:  
 F17438\_HEKLA-G2-I

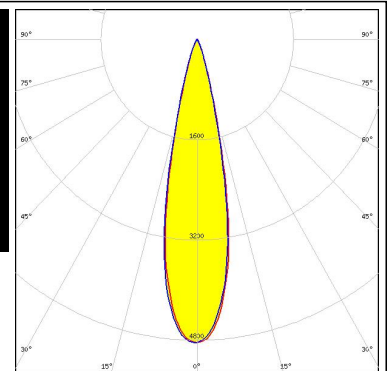
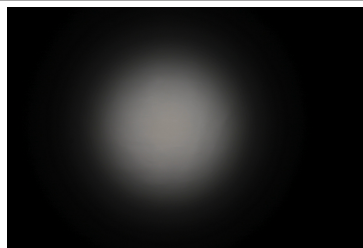

SEOUL SEMICONDUCTOR  
 LED MJT COB LES 14.5  
 Ordering code CP18775\_YASMEEN-70-S-C2-WHT  
 FWHM / FWTM 23.0° / 39.0°  
 Efficiency 92 %  
 Peak intensity 4.9 cd/lm  
 LEDs/each optic 1  
 Light colour White  
 Required components:  
 F17438\_HEKLA-G2-I

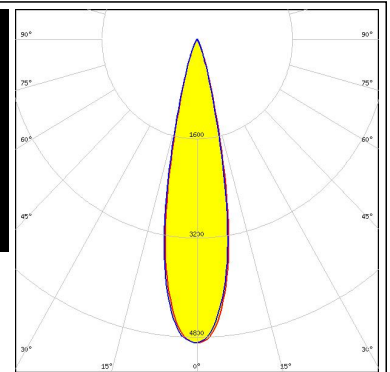
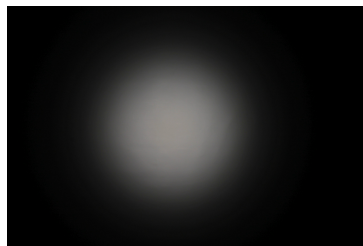

### OPTICAL RESULTS (MEASURED):

#### TRIDONIC

LED SLE G7 LES09  
Ordering code CP18775\_YASMEEN-70-S-C2-WHT  
FWHM / FWTM 15.0° / 25.0°  
Efficiency 93 %  
Peak intensity 11.3 cd/lm  
LEDs/each optic 1  
Light colour White  
Required components:  
F17435\_HEKLA-G2-C

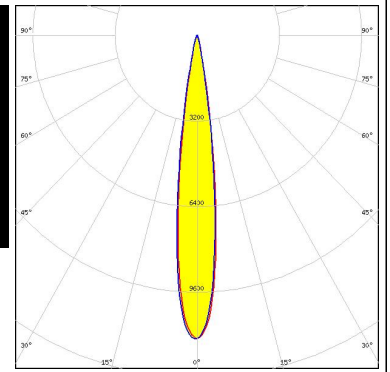
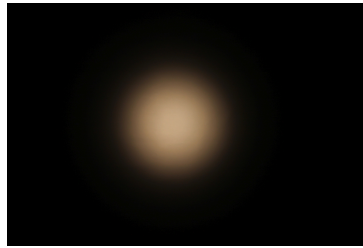

#### TRIDONIC

LED SLE G7 LES15  
Ordering code CP18751\_YASMEEN-70-S-C2  
FWHM / FWTM 22.0° / 38.0°  
Efficiency 85 %  
Peak intensity 5.1 cd/lm  
LEDs/each optic 1  
Light colour White  
Required components:  
F17438\_HEKLA-G2-I

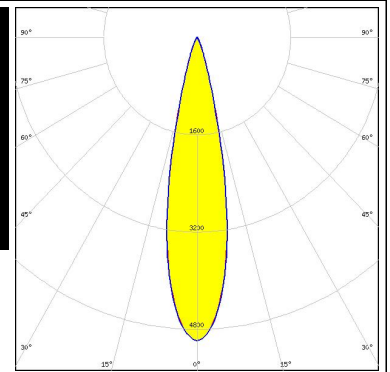

#### TRIDONIC

LED SLE G7 LES15  
Ordering code CP18775\_YASMEEN-70-S-C2-WHT  
FWHM / FWTM 22.0° / 38.0°  
Efficiency 92 %  
Peak intensity 5.1 cd/lm  
LEDs/each optic 1  
Light colour White  
Required components:  
F17438\_HEKLA-G2-I

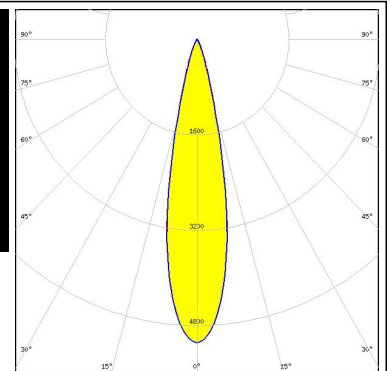
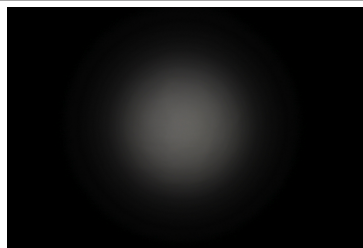

### OPTICAL RESULTS (SIMULATED):

bridgelux.

LED V10 Gen 8  
 Ordering code CP18768\_YASMEEN-70-S-B2  
 FWHM / FWTM 16.0° / 28.0°  
 Efficiency 88 %  
 Peak intensity 9.9 cd/lm  
 LEDs/each optic 1  
 Light colour White  
 Required components:  
 BJB: 47.360.1020

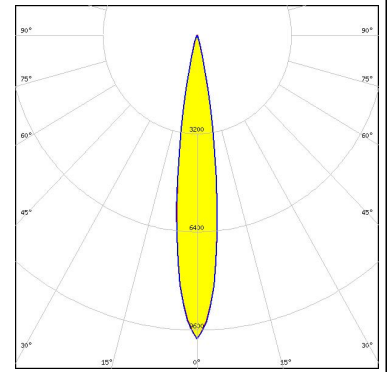

bridgelux.

LED V13 Gen7  
 Ordering code C17238\_YASMEEN-70-S  
 FWHM / FWTM 22.0° / 36.0°  
 Efficiency 90 %  
 Peak intensity 5.9 cd/lm  
 LEDs/each optic 1  
 Light colour White  
 Required components:

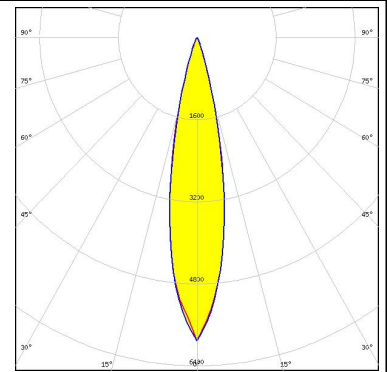

bridgelux.

LED V6 HD Gen 7  
 Ordering code CP18751\_YASMEEN-70-S-C2  
 FWHM / FWTM 12.0° / 22.0°  
 Efficiency 89 %  
 Peak intensity 15.6 cd/lm  
 LEDs/each optic 1  
 Light colour White  
 Required components:  
 F15255\_HEKLA-SOCKET-C

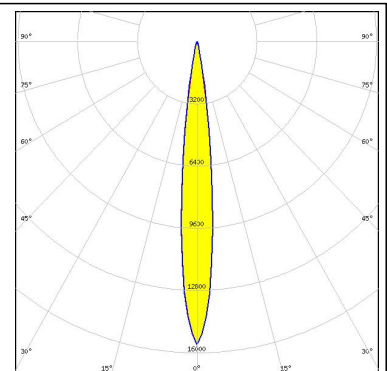

bridgelux.

LED Vesta TW 13mm (25W) CSP  
 Ordering code CP18751\_YASMEEN-70-S-C2  
 FWHM / FWTM 20.0° / 34.0°  
 Efficiency 90 %  
 Peak intensity 6.5 cd/lm  
 LEDs/each optic 1  
 Light colour White  
 Required components:  
 C16142\_HEKLA-SOCKET-K

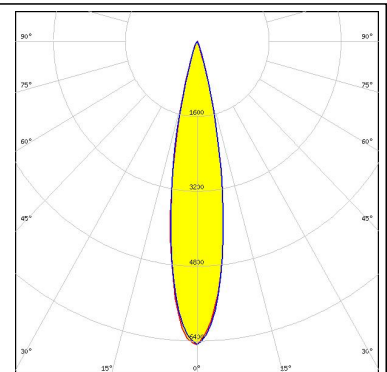



### OPTICAL RESULTS (SIMULATED):



**LED** Vesta TW 9mm (12W) CSP  
**Ordering code** CP18751\_YASMEEN-70-S-C2  
**FWHM / FWTM** 16.0° / 30.0°  
**Efficiency** 90 %  
**Peak intensity** 8.6 cd/lm  
**LEDs/each optic** 1  
**Light colour** White  
**Required components:**  
 C16142\_HEKLA-SOCKET-K

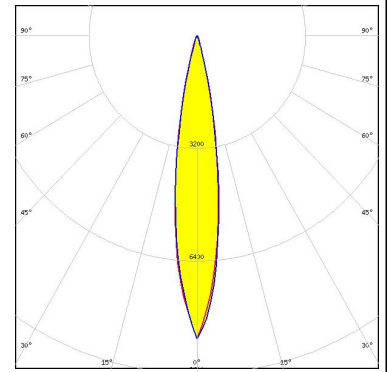

### CITIZEN

**LED** CLL02x/CLU02x (LES10)  
**Ordering code** CP18768\_YASMEEN-70-S-B2  
**FWHM / FWTM** 16.0° / 28.0°  
**Efficiency** 88 %  
**Peak intensity** 9.8 cd/lm  
**LEDs/each optic** 1  
**Light colour** White  
**Required components:**  
 BJB: 47.360.1020

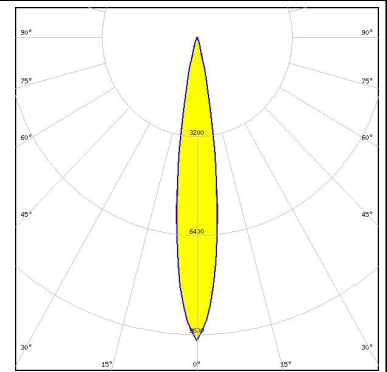

### CITIZEN

**LED** CLU712/713  
**FWHM / FWTM** 14.0° / 26.0°  
**Efficiency** 94 %  
**Peak intensity** 11.4 cd/lm  
**LEDs/each optic** 1  
**Light colour** White  
**Required components:**

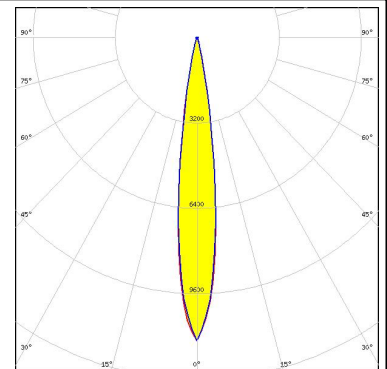

### CITIZEN

**LED** CLU712/713  
**Ordering code** CP18775\_YASMEEN-70-S-C2-WHT  
**FWHM / FWTM** 14.0° / 26.0°  
**Efficiency** 93 %  
**Peak intensity** 11.3 cd/lm  
**LEDs/each optic** 1  
**Light colour** White  
**Required components:**  
 F17438\_HEKLA-G2-I

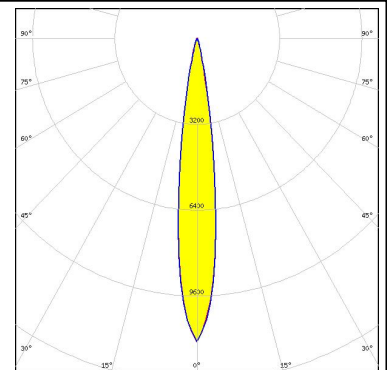

### OPTICAL RESULTS (SIMULATED):

#### CITIZEN

LED CLU712/713  
 Ordering code C17238\_YASMEEN-70-S  
 FWHM / FWTM 14.0° / 26.0°  
 Efficiency 94 %  
 Peak intensity 11.4 cd/lm  
 LEDs/each optic 1  
 Light colour White  
 Required components:

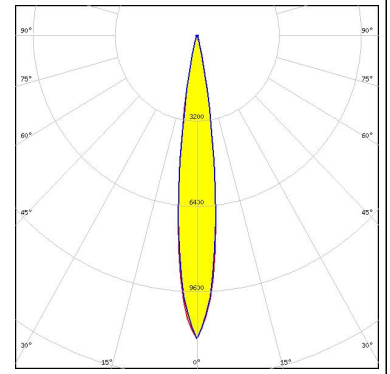

#### CITIZEN

LED CLU712/713  
 Ordering code CP18768\_YASMEEN-70-S-B2  
 FWHM / FWTM 14.0° / 26.0°  
 Efficiency 88 %  
 Peak intensity 11.2 cd/lm  
 LEDs/each optic 1  
 Light colour White  
 Required components:  
 BJB: 47.360.1010

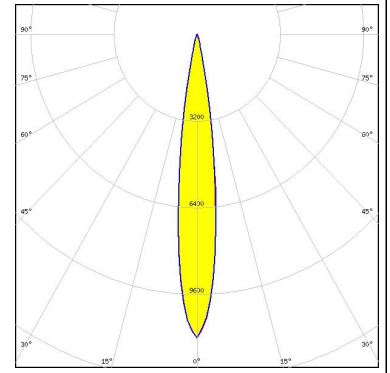

#### CITIZEN

LED CLU712/713  
 Ordering code CP18751\_YASMEEN-70-S-C2  
 FWHM / FWTM 14.0° / 26.0°  
 Efficiency 87 %  
 Peak intensity 11.3 cd/lm  
 LEDs/each optic 1  
 Light colour White  
 Required components:  
 F17438\_HEKLA-G2-I

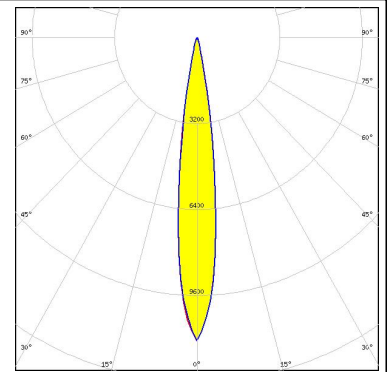

#### CITIZEN

LED CLU7A2/7A3  
 Ordering code CP18768\_YASMEEN-70-S-B2  
 FWHM / FWTM 10.0° / 20.0°  
 Efficiency 89 %  
 Peak intensity 18.7 cd/lm  
 LEDs/each optic 1  
 Light colour White  
 Required components:  
 BJB: 47.360.1020

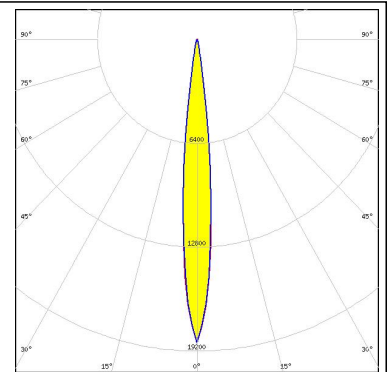

### OPTICAL RESULTS (SIMULATED):



**LED** CHA0304  
**Ordering code** CP18751\_YASMEEN-70-S-C2  
**FWHM / FWTM** 10.0° / 20.0°  
**Efficiency** 88 %  
**Peak intensity** 19.5 cd/lm  
**LEDs/each optic** 1  
**Light colour** White  
**Required components:**  
 F17435\_HEKLA-G2-C

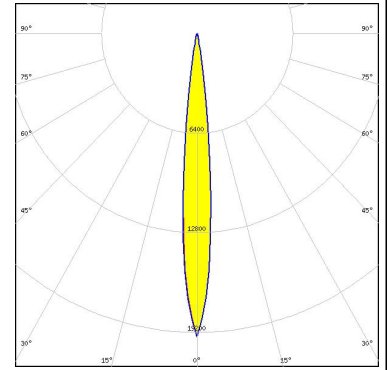

**LED** CHA0410  
**Ordering code** CP18751\_YASMEEN-70-S-C2  
**FWHM / FWTM** 10.0° / 20.0°  
**Efficiency** 88 %  
**Peak intensity** 18.6 cd/lm  
**LEDs/each optic** 1  
**Light colour** White  
**Required components:**  
 F17435\_HEKLA-G2-C

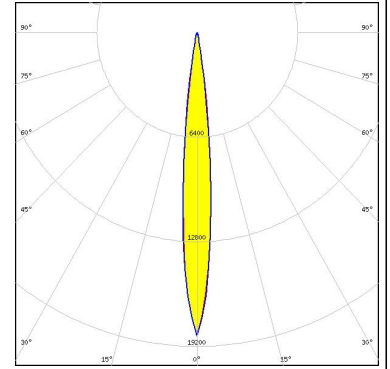

**LED** CHA0612  
**Ordering code** CP18751\_YASMEEN-70-S-C2  
**FWHM / FWTM** 12.0° / 22.0°  
**Efficiency** 88 %  
**Peak intensity** 15.3 cd/lm  
**LEDs/each optic** 1  
**Light colour** White  
**Required components:**  
 F17435\_HEKLA-G2-C

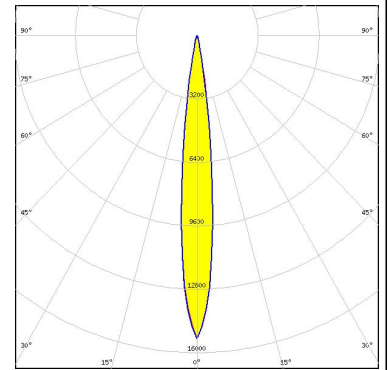

**LED** CMA1306  
**Ordering code** CP18751\_YASMEEN-70-S-C2  
**FWHM / FWTM** 12.0° / 22.0°  
**Efficiency** 88 %  
**Peak intensity** 16.1 cd/lm  
**LEDs/each optic** 1  
**Light colour** White  
**Required components:**  
 F17435\_HEKLA-G2-C

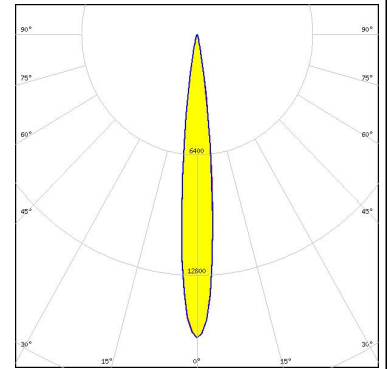

### OPTICAL RESULTS (SIMULATED):

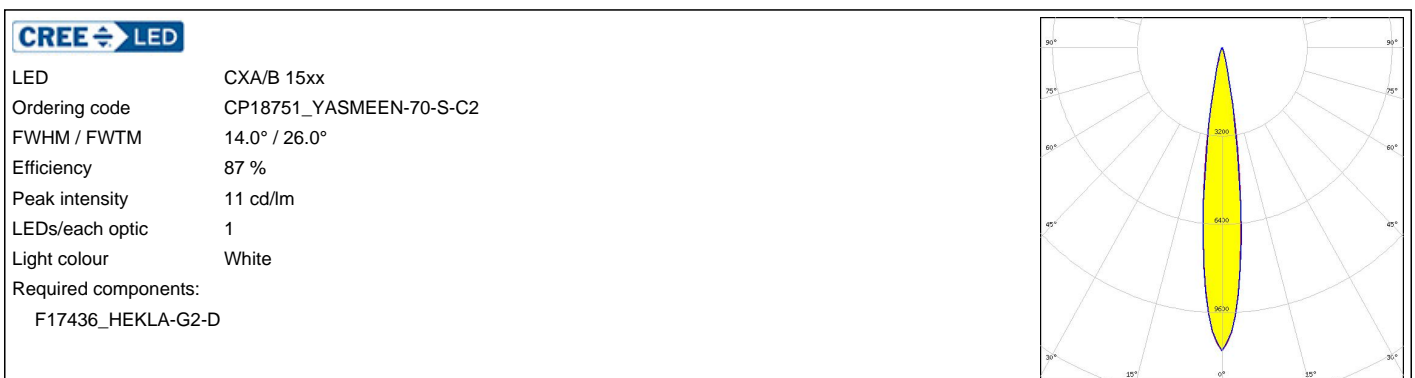

### OPTICAL RESULTS (SIMULATED):



LED CXA/B 1830  
Ordering code CP18751\_YASMEEN-70-S-C2  
FWHM / FWTM 22.0° / 36.0°  
Efficiency 87 %  
Peak intensity 5.5 cd/lm  
LEDs/each optic 1  
Light colour White  
Required components:  
Bender Wirth: 637b Hekla

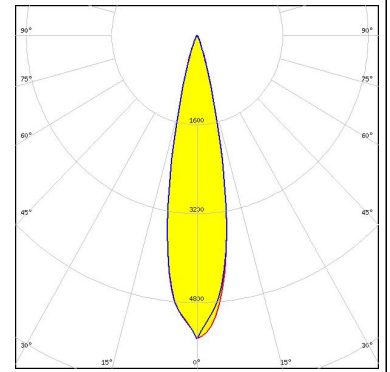

LED Fortimo SLM L09 CoB  
Ordering code CP18751\_YASMEEN-70-S-C2  
FWHM / FWTM 16.0° / 28.0°  
Efficiency 88 %  
Peak intensity 10 cd/lm  
LEDs/each optic 1  
Light colour White  
Required components:  
F17435\_HEKLA-G2-C

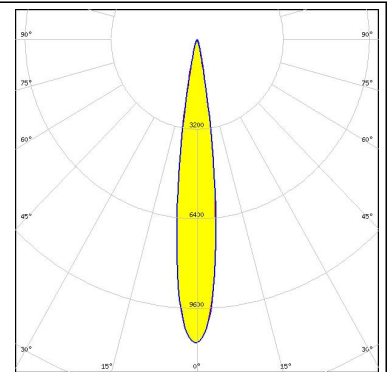

LED Fortimo SLM L13 CoB  
Ordering code CP18751\_YASMEEN-70-S-C2  
FWHM / FWTM 16.0° / 28.0°  
Efficiency 87 %  
Peak intensity 10.1 cd/lm  
LEDs/each optic 1  
Light colour White  
Required components:  
Bender Wirth: 632a Hekla XL

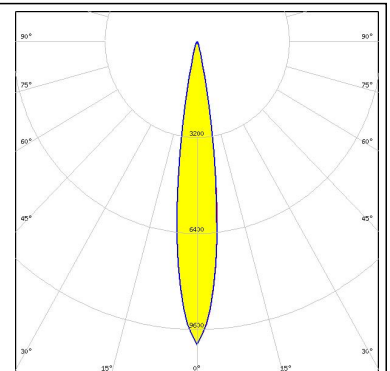

LED LC003D / LC006D / LC009D / LC013D  
Ordering code CP18751\_YASMEEN-70-S-C2  
FWHM / FWTM 16.0° / 28.0°  
Efficiency 87 %  
Peak intensity 8.8 cd/lm  
LEDs/each optic 1  
Light colour White  
Required components:  
F17435\_HEKLA-G2-C

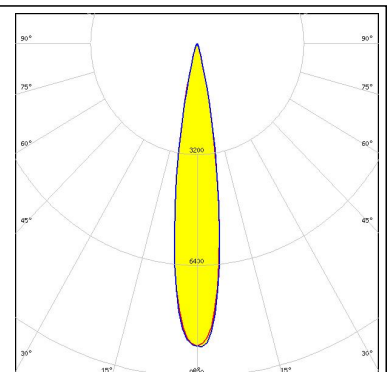

### OPTICAL RESULTS (SIMULATED):

#### SAMSUNG

LED LC003D / LC006D / LC009D / LC013D  
Ordering code CP18768\_YASMEEN-70-S-B2  
FWHM / FWTM 16.0° / 29.0°  
Efficiency 85 %  
Peak intensity 9 cd/lm  
LEDs/each optic 1  
Light colour White  
Required components:  
BJB: 47.360.1020

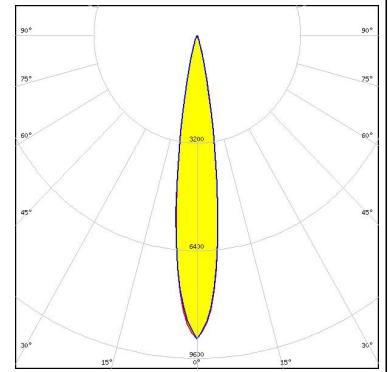

#### SAMSUNG

LED LC010C G2  
Ordering code CP18768\_YASMEEN-70-S-B2  
FWHM / FWTM 12.0° / 22.0°  
Efficiency 89 %  
Peak intensity 15.7 cd/lm  
LEDs/each optic 1  
Light colour White  
Required components:  
BJB: 47.360.1020

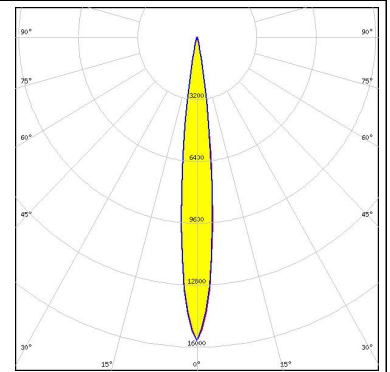

#### SAMSUNG

LED LC016D / LC019D / LC026D / LC033D  
Ordering code CP18768\_YASMEEN-70-S-B2  
FWHM / FWTM 24.0° / 42.0°  
Efficiency 85 %  
Peak intensity 4.4 cd/lm  
LEDs/each optic 1  
Light colour White  
Required components:  
BJB: 47.360.1010

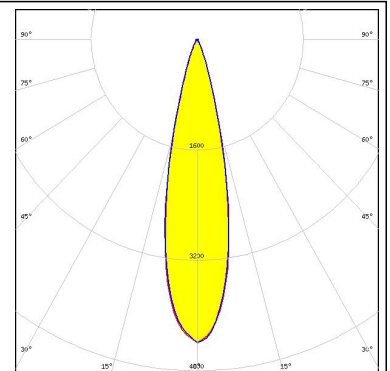

#### SAMSUNG

LED LC020C G2  
Ordering code CP18768\_YASMEEN-70-S-B2  
FWHM / FWTM 14.0° / 26.0°  
Efficiency 88 %  
Peak intensity 10.9 cd/lm  
LEDs/each optic 1  
Light colour White  
Required components:  
BJB: 47.360.1010

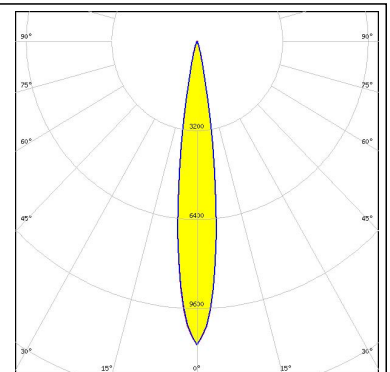

### OPTICAL RESULTS (SIMULATED):

#### SAMSUNG

LED LC030C/040C G2  
Ordering code CP18768\_YASMEEN-70-S-B2  
FWHM / FWTM 18.0° / 32.0°  
Efficiency 88 %  
Peak intensity 7.2 cd/lm  
LEDs/each optic 1  
Light colour White  
Required components:  
BJB: 47.360.1010

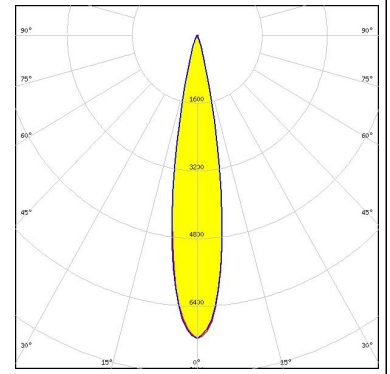

#### TRIDONIC

LED SLE G7 LES13  
Ordering code CP18751\_YASMEEN-70-S-C2  
FWHM / FWTM 20.0° / 34.0°  
Efficiency 87 %  
Peak intensity 6.1 cd/lm  
LEDs/each optic 1  
Light colour White  
Required components:  
F17438\_HEKLA-G2-I

