

CPDV6-5V0U-HF

RoHS Device
Halogen Free

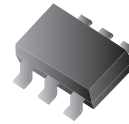

Features

- EC61000-4-2 Level 4 ESD protection.
- Surface mount package.
- High component density.

Mechanical data

- Case: SOT-363 Standard package, molded plastic.
- Terminals: Solderable per MIL-STD-750, method 2026.
- Marking code: E5U
- Mounting position: Any.
- Weight: 0.0091 gram (approx.)

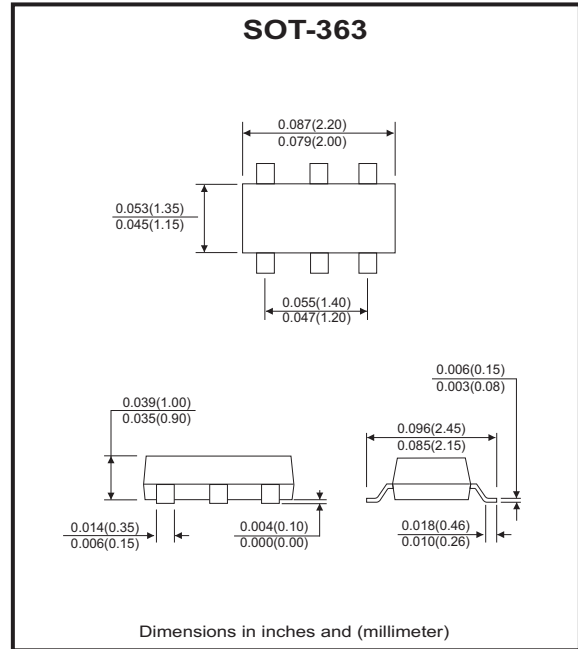

Circuit diagram

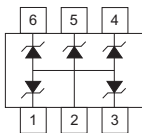

Maximum Rating and Electrical Characteristics

(at TA=25°C unless otherwise noted)

Parameter	Symbol	Conditions	Min	Typ	Max	Unit
Diode breakdown voltage	V _{BD}	I _R = 1mA	6.1			V
Leakage current	I _L	V _R = 3V		0.1	1.0	uA
Forward voltage	V _F	I _F = 10mA			1.2	V
Junction capacitance	C _T	V _R = 0V, f = 1MHz		60	80	pF
ESD capability	ESD	IEC 61000-4-2(air) IEC 61000-4-2(contact)			15 8	kV
Clamping voltage	V _C	I _{PP} = 1A, T _P =8/20us I _{PP} = 8A, T _P =8/20us			8 10	V
Peak pulse power	P _{PP}				80	W
Operation temperature	T _J				125	°C
Storage temperature	T _{STG}		-55		150	°C

RATING AND CHARACTERISTIC CURVES (CPDV6-5V0U-HF)

Fig. 1 - 8/20us Peak pulse current waveform acc. IEC 61000-4-5

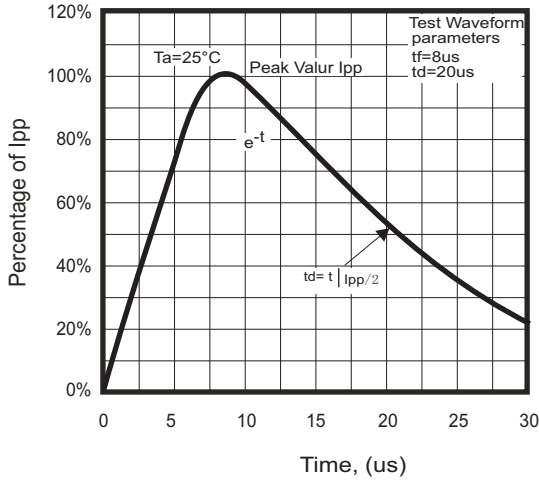

Fig.2 - Power rating derating curve

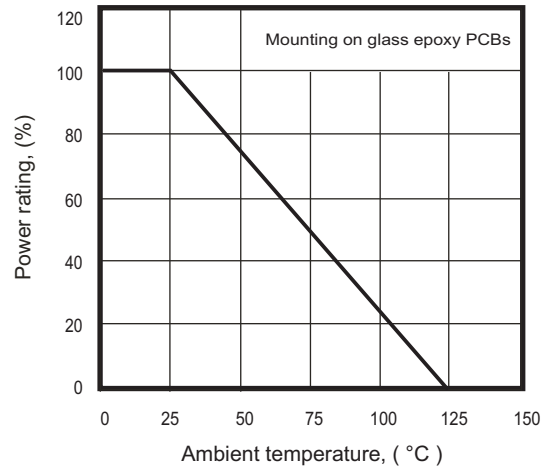

Fig.3 - Clamping voltage vs. peak pulse current

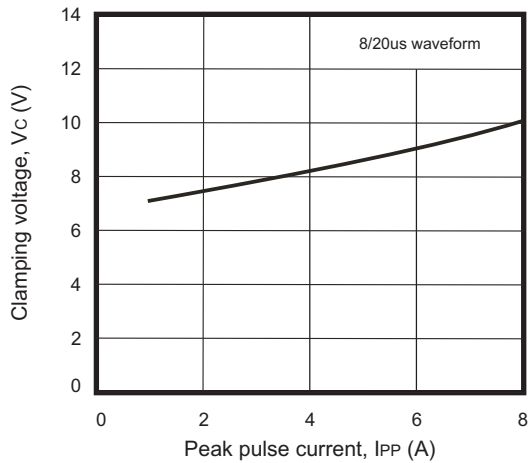
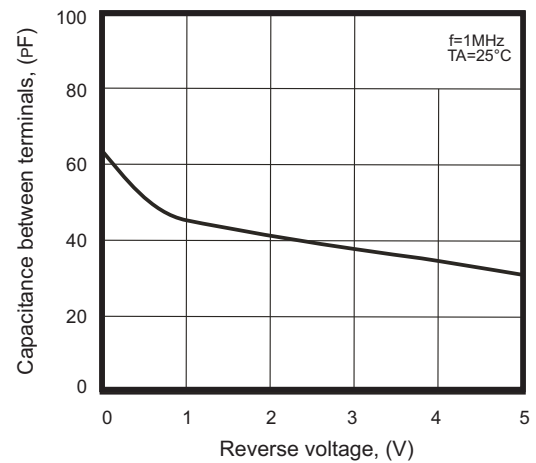
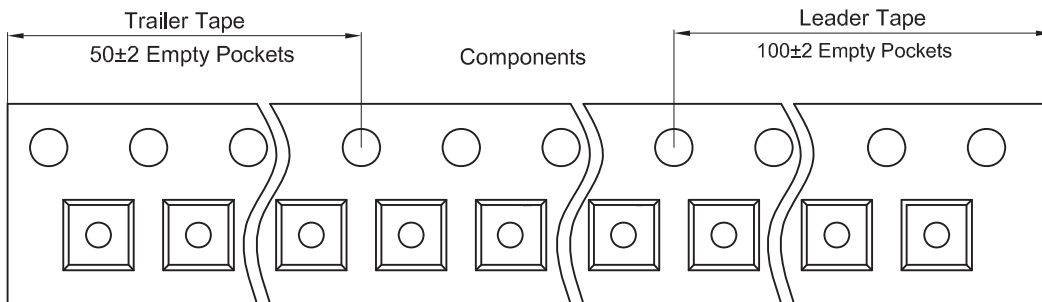
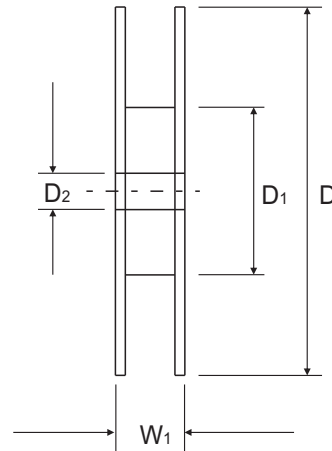
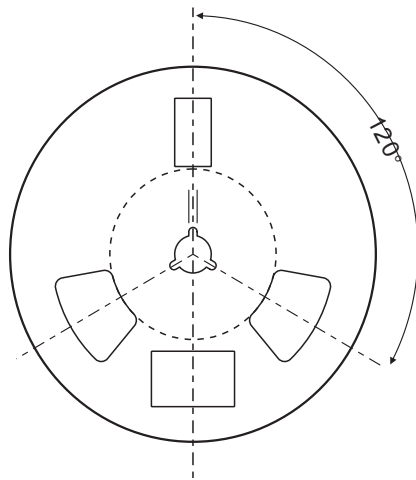
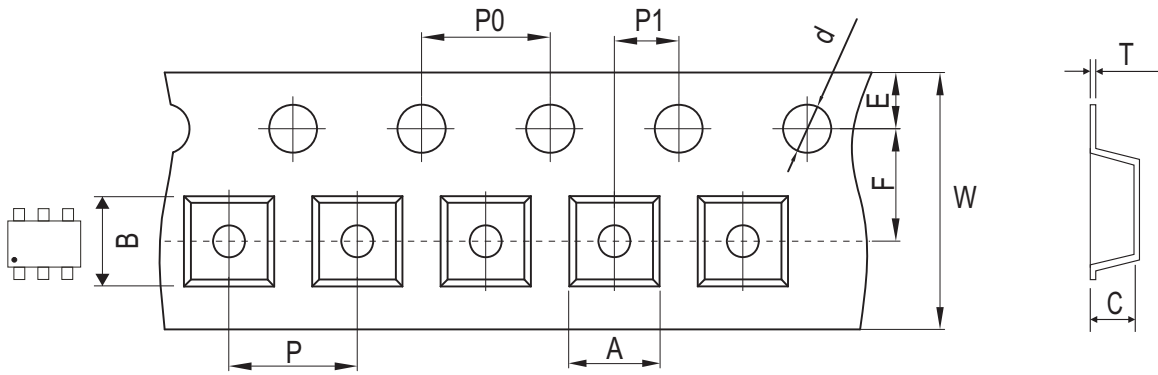

Fig.4 - Capacitance between terminals characteristics



Reel Taping Specification



SOT-363	SYMBOL	A	B	C	d	D	D1	D2
	(mm)	2.25 ± 0.05	2.55 ± 0.05	1.20 ± 0.05	1.50 ± 0.10	178 ± 2.00	54.40 ± 1.00	13.00 ± 1.00
	(inch)	0.089 ± 0.002	0.100 ± 0.002	0.047 ± 0.002	0.059 ± 0.004	7.008 ± 0.079	2.142 ± 0.039	0.512 ± 0.039

SOT-363	SYMBOL	E	F	P	P0	P1	W	W1
	(mm)	1.75 ± 0.10	3.50 ± 0.10	4.00 ± 0.10	4.00 ± 0.10	2.00 ± 0.10	8.00 + 0.30 / - 0.10	12.30 ± 1.00
	(inch)	0.069 ± 0.004	0.138 ± 0.004	0.157 ± 0.004	0.157 ± 0.004	0.079 ± 0.004	0.315 + 0.012 / - 0.004	0.484 ± 0.039