



Features

4.240 GHz

Standard 3 Wire Interface

Small layout 0.582" × 0.8"



Applications

Digital Radio Equipment

Fixed Wireless Access

Satellite Communications Systems

Base Stations

Personal Communications Systems

Portable Radios

Test Instruments

Wireless Infrastructure



The CPLL58 is a complete PLL/Synthesizer needing only an external frequency reference and supply voltages for the internal PLL (phase lock loop) and VCO (voltage controlled oscillator). The Crystek CPLL58 is programmed using a standard three line interface (Data, Clock and Load Enable).

The CPLL58 family has been initially released to cover 1 GHz to 5 GHz in bands. It is housed in a compact 0.582-in. × 0.8-in. × 0.15-in. SMD package which saves board space. Typical phase noise at 4 GHz is -90 dBc/Hz at 10 kHz offset with 0 dBm minimum output power.



PERFORMANCE SPECIFICATION	MIN	TYP	MAX	UNITS
Frequency Range:		4.240		GHz
Step Size:		2500		kHz
Settling Time, to within ± 1kHz (Freq. step < 25MHz):		1		msec
Output Power:	0	+3.0	+6.0	dBm
Output Phase Noise: (See Plot Below)				
@1kHz offset		-75	-70	dBc/Hz
@10kHz offset		-90	-85	dBc/Hz
@100kHz offset		-105	-100	dBc/Hz
@1MHz offset		-135	-130	dBc/Hz
Power Supply:				
V1=VCO Supply	4.75	5.0	5.25	Volts
V2=PLL Supply	2.7	3.0	3.3	Volts
Supply Current:				
I1=VCO Input Current		50		mA
I2=PLL Input Current		25		mA
Spurious Suppression				dBc
PFDSpur		-70	-60	dBc
Reference Feedthru		-80	-70	dBc
Harmonic Suppression:				
2 nd		-15	-10	dBc
Reference Frequency		10		MHz
RF Output Level	-5	0	+5	dBm
Input Reference Level	0.8		V2	Vp-p
Input Impedance		100k		Ohm
RF Output Impedance		50		Ohm
Operating Temperature Range:	-40		+85	°C
Logic Inputs (Clock, Data, and LE):				
Input "High" Voltage	1.4			
Input "Low" Voltage			0.6	Volts
Locked Detector (LD):				
Locked	1.4			Volts
Un-Locked			0.4	Volts

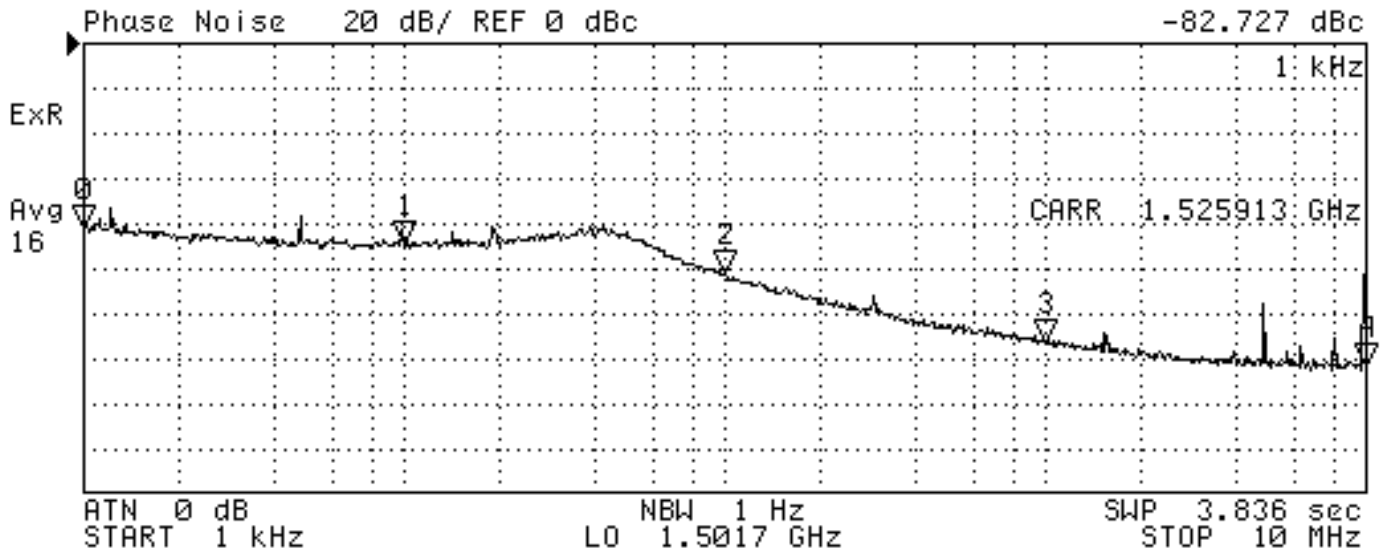

N	SWP PARAM	VAL
0	1 kHz	-82.727 dBc
1	10 kHz	-89.447 dBc
2	100 kHz	-103.5 dBc
3	1 MHz	-133.44 dBc
4	10 MHz	-143.98 dBc



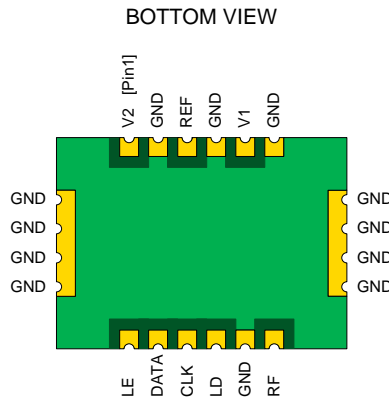
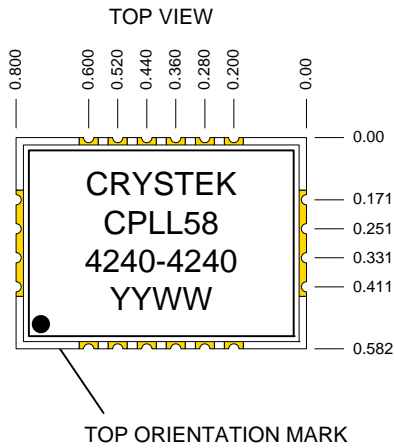

- LE = Load Enable, CMOS Input
- DATA = Serial Data Input
- CLK = Clock
- LD = Lock Detect
- REF = Reference Input
- V1 = Analog Supply Input (VCO)
- V2 = Digital Supply Input (PLL)
- RF = RF Output

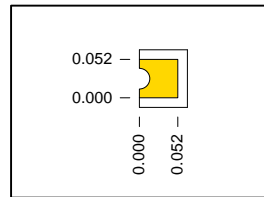

Pad Detail

RECOMMENDED REFLOW SOLDERING PROFILE

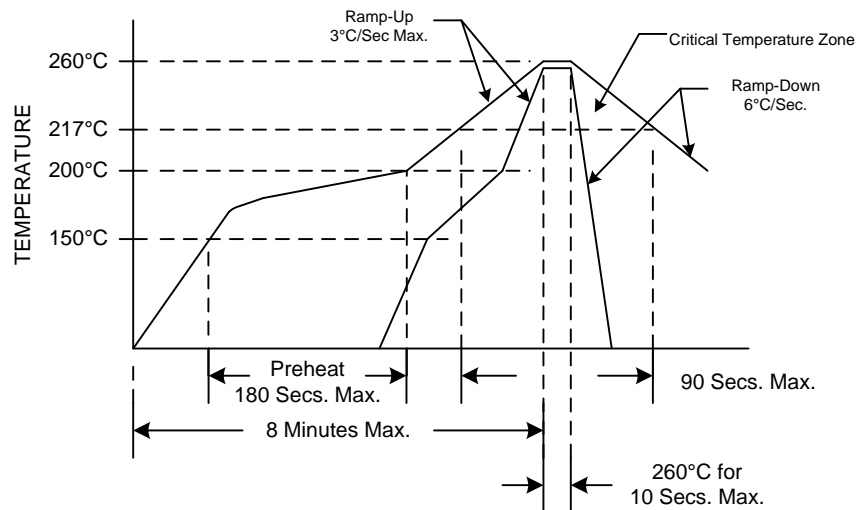



ENVIRONMENTAL COMPLIANCE

Parameter	Conditions
Mechanical Shock	MIL-STD-883, Method 2002
Mechanical Vibration	MIL-STD-883, Method 2007
Solderability	MIL-STD-883, Method 1014
Resistance to Solvents	MIL-STD-883, Method 2016

Programming Guide for CPLL58-XXXX

Introduction

The CPLL58 uses a simple 3 wire interface to program four internal registers. See Figure 1.

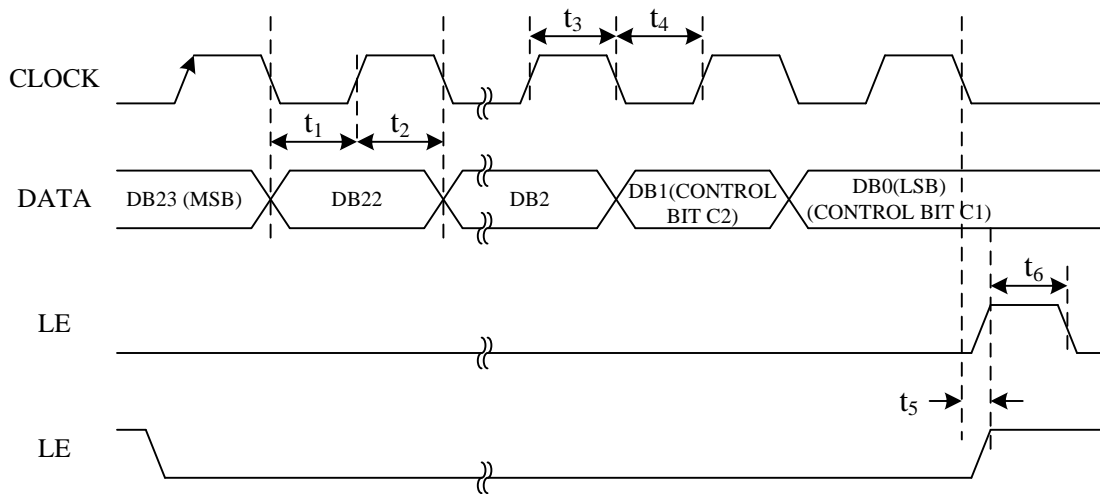

Figure 1. Timing Diagram

There are four 24 bit registers that need to be programmed. Which register is written into is simply controlled by Control Bits C1 and C2. Table I summarizes the Truth Table for Control Bits C1 and C2.

Control Bits		Data Latch
C2	C1	
0	0	R Counter
0	1	N Counter (A and B)
1	0	Function Latch (Including Prescaler)
1	1	Initialization Latch

Table I. C2, C1 Truth Table



Table II shows the details of the four 24 bit registers.

REFERENCE COUNTER LATCH																							
RESERVED			LOCK DETECT PRECISION	TEST MODE BITS			ANTI-BACKLASH WIDTH		14-BIT REFERENCE COUNTER													CONTROL BITS	
DB23	DB22	DB21	DB20	DB19	DB18	DB17	DB16	DB15	DB14	DB13	DB12	DB11	DB10	DB9	DB8	DB7	DB6	DB5	DB4	DB3	DB2	DB1	DB0
X	0	0	LDP	T2	T1	ABP2	ABP1	R14	R13	R12	R11	R10	R9	R8	R7	R6	R5	R4	R3	R2	R1	C2(0)	C1(0)

N COUNTER LATCH																							
RESERVED		CP GAIN	13-BIT COUNTER													6-BIT COUNTER						CONTROL BITS	
DB23	DB22	DB21	DB20	DB19	DB18	DB17	DB16	DB15	DB14	DB13	DB12	DB11	DB10	DB9	DB8	DB7	DB6	DB5	DB4	DB3	DB2	DB1	DB0
		G1	B13	B12	B11	B10	B9	B8	B7	B6	B5	B4	B3	B2	B1	A6	A5	A4	A3	A2	A1	C2(0)	C1(1)

FUNCTION LATCH																							
PRESCALER VALUE		POWER-DOWN ₂	CURRENT SETTING ₂			CURRENT SETTING ₁			TIMER COUNTER CONTROL				FASTLOCK MODE	FASTLOCK ENABLE	CP THREE-STATE	PD POLARITY	MUXOUT CONTROL			POWER-DOWN ₁	COUNTER RESET	CONTROL BITS	
DB23	DB22	DB21	DB20	DB19	DB18	DB17	DB16	DB15	DB14	DB13	DB12	DB11	DB10	DB9	DB8	DB7	DB6	DB5	DB4	DB3	DB2	DB1	DB0
P2	P1	PD2	CP16	CP15	CP14	CP13	CP12	CP11	TC4	TC3	TC2	TC1	F5	F4	F3	F2	M3	M2	M1	PD1	F1	C2(1)	C1(0)

INITIALIZATION LATCH																							
PRESCALER VALUE		POWER-DOWN ₂	CURRENT SETTING ₂			CURRENT SETTING ₁			TIMER COUNTER CONTROL				FASTLOCK MODE	FASTLOCK ENABLE	CP THREE-STATE	PD POLARITY	MUXOUT CONTROL			POWER-DOWN ₁	COUNTER RESET	CONTROL BITS	
DB23	DB22	DB21	DB20	DB19	DB18	DB17	DB16	DB15	DB14	DB13	DB12	DB11	DB10	DB9	DB8	DB7	DB6	DB5	DB4	DB3	DB2	DB1	DB0
P2	P1	PD2	CP16	CP15	CP14	CP13	CP12	CP11	TC4	TC3	TC2	TC1	F5	F4	F3	F2	M3	M2	M1	PD1	F1	C2(1)	C1(1)

Table II. Latch Summary

When using the CPLL58 family in a synthesizer application, all four 24 bit registers need to be written into after power-up. After writing all four latches the first time, subsequent frequency step changes can be accomplished by changing the N Counter Latch only.

Specifications subject to change without notice.