

PART NUMBER	DESCRIPTION
CCT-49K	Commercial Latching Multi-throw, DC-40 GHz
CT-49K	Elite Latching Multi-throw, DC-40GHz

The CCT-49K/CT-49K is an Internally Terminated broadband, multi-throw, electromechanical coaxial switch designed to switch a microwave signal from a common input to any of 3, 4, 5, or 6 outputs. The characteristic impedance is 50 Ohms. Internal terminations provide an impedance match for the unselected ports. The switches are small using the popular connector spacing on a 1.062" dia. circle. Each position has an individual actuator mechanism allowing random position selection. This also minimizes switching time.

The CCT-49K/CT-49K comes with a latching actuator. The latching switch remains in the last position selected when the switch is de-energized. STD dual command requires a reset pulse before a new selected position. A separate reset circuit allows all positions to be set to an open position. User must provide both reset (clear) and set (select new position) commands.



ENVIRONMENTAL AND PHYSICAL CHARACTERISTICS	
Operating Temperature	
Commercial Model, CCT-49K	-25°C to 65°C
Elite Model, CT-49K***	-55°C to 85°C
Vibration (MIL-STD-202 Method 214, Condition D, non-operating)	10 g's RMS
Shock (MIL-STD-202 Method 213, Condition D, non-operating)	500 g's
Standard Actuator Life	5,000,000 cycles
Actuator Life w/ Additional Features	1,000,000 cycles
Connector Type	2.92mm (K)
Humidity (Moisture Seal)	Available
Weight	6 oz. (170.1g) (max.)

ELECTRICAL CHARACTERISTICS	
Form Factor	Multi-Throw, break before make
Frequency Range	
CCT-49K	DC-40 GHz
CT-49K	DC-40 GHz
Characteristic Impedance	50 Ohms
Operate Time	20 ms (max.)
Terminations	50Ω
Actuation Voltage Available	12 15 24 28 V
Actuation Current	255 205 130 90 mA
Reset Current (# of Positions)	3 765 615 390 270 mA
	4 1020 820 520 360 mA
	5 1275 1025 650 450 mA
	6 1530 1230 780 540 mA

PERFORMANCE CHARACTERISTICS						
Frequency	DC-6 GHz	6-12 GHz	12-18 GHz	18-26.5 GHz	26.5-32 GHz	32-40 GHz
Insertion Loss, dB, max.	0.20	0.30	0.60	0.80	0.80	1.40
Isolation, dB, min.	80	75	70	70	60	60
VSWR , max.	1.25:1	1.30:1	1.60:1	1.70:1	1.80:1	1.95:1

For maximum limits, please see charts on pages 7-8

PART NUMBERING SYSTEM

CCT-49 K 6 6 C - I**

Series

Connectors

Actuator Voltage

Options

Actuator Type

Number of Positions

CONNECTOR	ACTUATOR VOLTAGE	NUMBER OF POSITIONS	ACTUATOR TYPE	OPTIONS
K: 2.92mm FEMALE	6: 28 VDC LATCHING	3: SP3T	0: NO INDICATOR CONTACTS	T: TTL DRIVERS WITH DIODES
	7: 15 VDC LATCHING	4: SP4T	C: INDICATOR CONTACTS***	D: COIL TRANSIENT SUPPRESSION DIODES
	8: 12 VDC LATCHING	5: SP5T	D: SELF CUTOFF ONLY	R: POSITIVE + COMMON
	9: 24 VDC LATCHING	6: SP6T		TD: DECODERS AND TTL DRIVERS WITH DIODES
				M: MOISTURE SEAL
				S: D-SUB CONNECTOR*

**SEE PARTS LIST ON PAGE 11-13
***Indicator Contacts Operating Temperature -50°C to 85°C (Elite Model Only)

For additional options, please contact factory.

* D-Sub Connector may be 9,15, 25 pin depending on number of throws. (See Connector Pinout page)

Series CCT-49K/CT-49K

Internal 50Ω Termination DC-40 GHz
Latching Multi-Throw Coaxial Switch



SCHEMATICS AND MECHANICAL OUTLINE

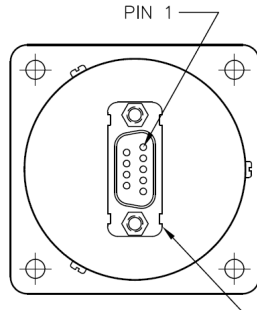
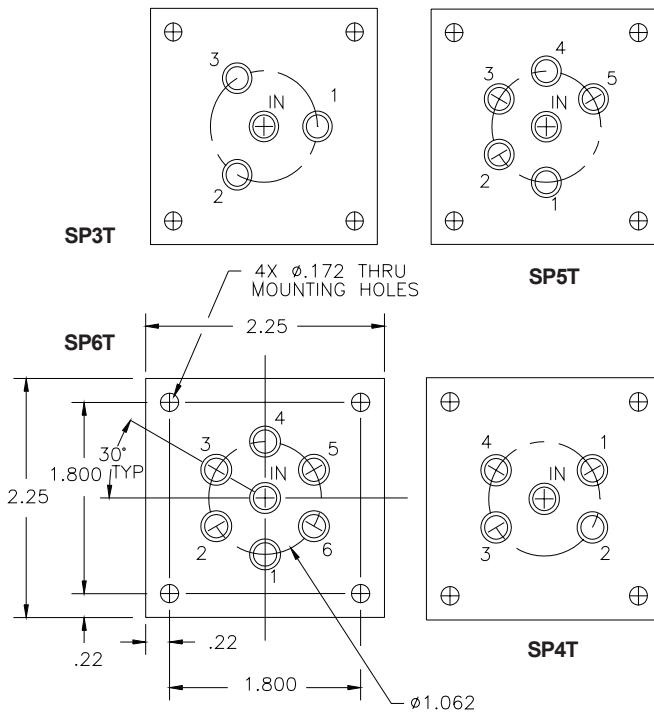
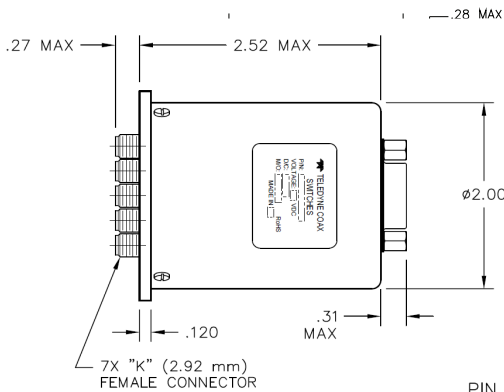
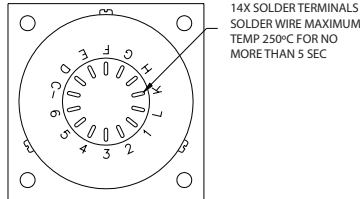
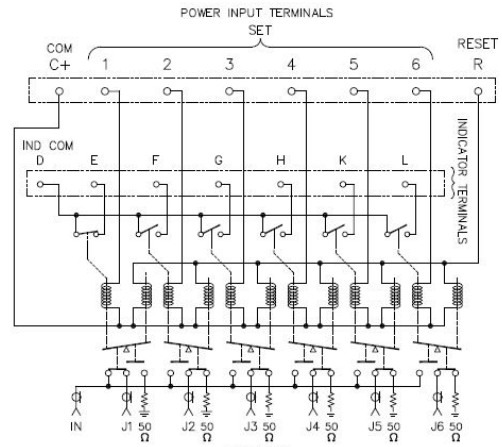
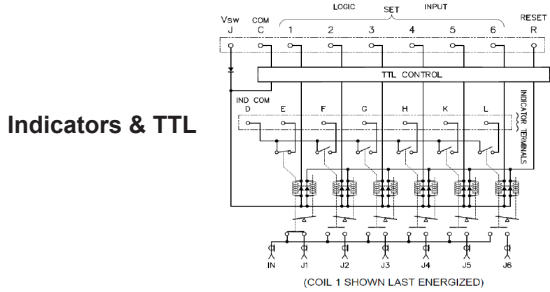
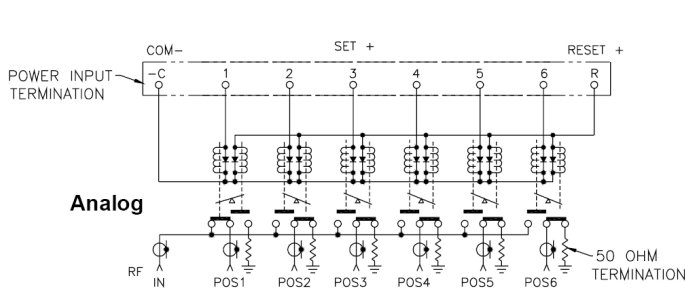

9-PIN D-SUB MINI CONNECTOR

MPL: CCT-49Ks660-S)

CONNECTOR PINOUT FOR LATCHING SP3T MULTI-THROW SWITCHES						
EXAMPLE	CT-49K630-S	CT49K63C-S	CT49K630-TS	CT49K63C-TS	CT49K630-TDS	CT49K63C-TDS
INDICATOR		Yes		Yes		Yes
TTL			Yes	Yes		
DECODERS & TTL					Yes	Yes
PIN NO.	9-PIN	15-PIN	9-PIN	15-PIN	9-PIN	15-PIN
1	PORT 1	PORT 1	TTL 1	TTL 1	LOGIC 1	LOGIC 1
2	PORT 2	PORT 2	TTL 2	TTL 2	LOGIC 2	LOGIC 2
3	PORT 3	PORT 3	TTL 3	TTL 3	LOGIC 3	LOGIC 3
4						
5						
6						
7	COMMON	COMMON	COMMON	COMMON	COMMON	COMMON
8	RESET	RESET	RESET	RESET		
9			VSW	VSW	VSW	VSW
10		D INDICATOR (COM)		D INDICATOR (COM)		D INDICATOR (COM)
11		E INDICATOR		E INDICATOR		E INDICATOR
12		F INDICATOR		F INDICATOR		F INDICATOR
13		G INDICATOR		G INDICATOR		G INDICATOR
14						
15						

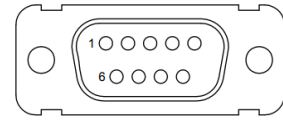

9-PIN D-SUB CONNECTOR

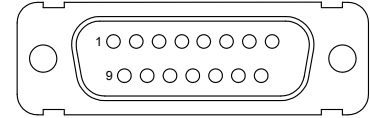

15-PIN D-SUB CONNECTOR

“-S option” 9-pin, 15-pin connector
(example: **CCT-49KS660-S**)

CONNECTOR PINOUT FOR LATCHING SP4T MULTI-THROW SWITCHES						
EXAMPLE	CT-49K640-S	CT49K64C-S	CT49K640-TS	CT49K64C-TS	CT49K640-TDS	CT49K64C-TDS
INDICATOR		Yes		Yes		Yes
TTL			Yes	Yes		
DECODERS & TTL					Yes	Yes
PIN NO.	9-PIN	15-PIN	9-PIN	15-PIN	9-PIN	15-PIN
1	PORT 1	PORT 1	TTL 1	TTL 1	LOGIC 1	LOGIC 1
2	PORT 2	PORT 2	TTL 2	TTL 2	LOGIC 2	LOGIC 2
3	PORT 3	PORT 3	TTL 3	TTL 3	LOGIC 3	LOGIC 3
4	PORT 4	PORT 4	TTL 4	TTL 4		
5						
6						
7	COMMON	COMMON	COMMON	COMMON	COMMON	COMMON
8	RESET	RESET	RESET	RESET		
9			VSW	VSW	VSW	VSW
10		D INDICATOR (COM)		D INDICATOR (COM)		D INDICATOR (COM)
11		E INDICATOR		E INDICATOR		E INDICATOR
12		F INDICATOR		F INDICATOR		F INDICATOR
13		G INDICATOR		G INDICATOR		G INDICATOR
14		H INDICATOR		H INDICATOR		H INDICATOR
15						

CONNECTOR PINOUT FOR LATCHING SP5T MULTI-THROW SWITCHES						
EXAMPLE	CT-49K650-S	CT49K65C-S	CT49K650-TS	CT49K65C-TS	CT49K650-TDS	CT49K65C-TDS
INDICATOR		Yes		Yes		Yes
TTL			Yes	Yes		
DECODERS & TTL					Yes	Yes
PIN NO.	9-PIN	15-PIN	9-PIN	15-PIN	9-PIN	15-PIN
1	PORT 1	PORT 1	TTL 1	TTL 1	LOGIC 1	LOGIC 1
2	PORT 2	PORT 2	TTL 2	TTL 2	LOGIC 2	LOGIC 2
3	PORT 3	PORT 3	TTL 3	TTL 3	LOGIC 3	LOGIC 3
4	PORT 4	PORT 4	TTL 4	TTL 4		
5	PORT 5	PORT 5	TTL 5	TTL 5		
6						
7	COMMON	COMMON	COMMON	COMMON	COMMON	COMMON
8	RESET	RESET	RESET	RESET		
9			VSW	VSW	VSW	VSW
10		D INDICATOR (COM)		D INDICATOR (COM)		D INDICATOR (COM)
11		E INDICATOR		E INDICATOR		E INDICATOR
12		F INDICATOR		F INDICATOR		F INDICATOR
13		G INDICATOR		G INDICATOR		G INDICATOR
14		H INDICATOR		H INDICATOR		H INDICATOR
15		K INDICATOR		K INDICATOR		K INDICATOR

Series CCT-49K/CT-49K

Internal 50Ω Termination DC-40 GHz
Latching Multi-Throw Coaxial Switch



CONNECTOR PINOUT FOR LATCHING SP6T MULTI-THROW SWITCHES						
EXAMPLE	CT-49K660-S	CT49K66C-S	CT49K660-TS	CT49K66C-TS	CT49K660-TDS	CT49K66C-TDS
INDICATOR		YES		YES		YES
TTL			YES	YES		
DECODERS & TTL					YES	YES
PIN NO.	9-PIN	15-PIN	9-PIN	15-PIN	9-PIN	15-PIN
1	PORT 1	PORT 1	TTL 1	TTL 1	LOGIC 1	LOGIC 1
2	PORT 2	PORT 2	TTL 2	TTL 2	LOGIC 2	LOGIC 2
3	PORT 3	PORT 3	TTL 3	TTL 3	LOGIC 3	LOGIC 3
4	PORT 4	PORT 4	TTL 4	TTL 4		
5	PORT 5	PORT 5	TTL 5	TTL 5		VSW
6	PORT 6	PORT 6	TTL 6	TTL 6		
7	COMMON	COMMON	COMMON	COMMON	COMMON	COMMON
8	RESET	RESET	RESET	RESET		
9		D INDICATOR (COM)	VSW	VSW	VSW	D INDICATOR (COM)
10		E INDICATOR				E INDICATOR
11		F INDICATOR				F INDICATOR
12		G INDICATOR				G INDICATOR
13		H INDICATOR				H INDICATOR
14		K INDICATOR				K INDICATOR
15		L INDICATOR				L INDICATOR
16				D INDICATOR (COM)		
17				E INDICATOR		
18				F INDICATOR		
19				G INDICATOR		
20				H INDICATOR		
21				K INDICATOR		
22				L INDICATOR		
23						
24						
25						

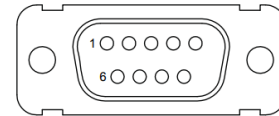

9-PIN D-SUB CONNECTOR

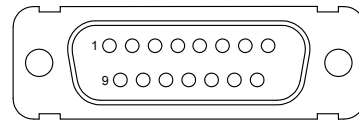

15-PIN D-SUB CONNECTOR

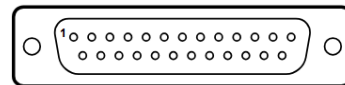

25-PIN D-SUB CONNECTOR

“-S option” 9-pin, 15-pin, 25-pin connector
(example: [CCT-49KS660-S](#))

TRUTH TABLE Latching
CCT-49KX3C-T

Logic Input				RF Path				Indicator Switches		
1	2	3	R	J1	J2	J3	Reset	E	F	G
1	0	0	0	On	Off	Off	Off	C	0	0
0	1	0	0	Off	On	Off	Off	0	C	0
0	0	1	0	Off	Off	On	Off	0	0	C

TRUTH TABLE Latching
CCT-49KX3C-TD

Logic Input			RF Path				Indicator Switches		
1	2	3	J1	J2	J3	Reset	E	F	G
0	0	0	On	Off	Off	Off	C	0	0
1	0	0	Off	On	Off	Off	0	C	0
0	1	0	Off	Off	On	Off	0	0	C
0	1	1	Off	Off	Off	Reset	0	0	0
1	1	1	COIL OFF				0	0	0

TRUTH TABLE Latching
CCT-49KX4C-T

Logic Input					RF Path					Indicator Switches			
1	2	3	4	R	J1	J2	J3	J4	Reset	E	F	G	H
1	0	0	0	0	On	Off	Off	Off	Off	C	0	0	0
0	1	0	0	0	Off	On	Off	Off	Off	0	C	0	0
0	0	1	0	0	Off	Off	On	Off	Off	0	0	C	0
0	0	0	1	0	Off	Off	Off	On	Off	0	0	0	C

TRUTH TABLE Latching
CCT-49KX4C-TD

Logic Input			RF Path					Indicator Switches			
1	2	3	J1	J2	J3	J4	Reset	E	F	G	H
0	0	0	On	Off	Off	Off	Off	C	0	0	0
1	0	0	Off	On	Off	Off	Off	0	C	0	0
0	1	0	Off	Off	On	Off	Off	0	0	C	0
1	1	0	Off	Off	Off	On	Off	0	0	0	C
0	1	1	Off	Off	Off	Off	Reset	0	0	0	0
1	1	1	COIL OFF					0	0	0	0

Series CCT-49K/CT-49K

Internal 50Ω Termination DC-40 GHz
Latching Multi-Throw Coaxial Switch



TRUTH TABLE Latching CCT-49KX5C-T

Logic Input						RF Path						Indicator Switches				
1	2	3	4	5	R	J1	J2	J3	J4	J5	Reset	E	F	G	H	K
1	0	0	0	0	0	On	Off	Off	Off	Off	Off	C	0	0	0	0
0	1	0	0	0	0	Off	On	Off	Off	Off	Off	0	C	0	0	0
0	0	1	0	0	0	Off	Off	On	Off	Off	Off	0	0	C	0	0
0	0	0	1	0	0	Off	Off	Off	On	Off	Off	0	0	0	C	0
0	0	0	0	1	0	Off	Off	Off	Off	On	Off	0	0	0	0	C

TRUTH TABLE Latching CCT-49KX5C-TD

Logic Input			RF Path					Indicator Switches					
1	2	3	J1	J2	J3	J4	J5	Reset	E	F	G	H	K
0	0	0	On	Off	Off	Off	Off	Off	C	0	0	0	0
1	0	0	Off	On	Off	Off	Off	Off	0	C	0	0	0
0	1	0	Off	Off	On	Off	Off	Off	0	0	C	0	0
1	1	0	Off	Off	Off	On	Off	Off	0	0	0	C	0
0	0	1	Off	Off	Off	Off	On	Off	0	0	0	0	C
0	1	1	Off	Off	Off	Off	Off	Reset	0	0	0	0	0
1	1	1	COIL OFF					0	0	0	0	0	

TRUTH TABLE Latching CCT-49KX6C-T

Logic Input							RF Path						Indicator Switches						
1	2	3	4	5	6	R	J1	J2	J3	J4	J5	J6	Reset	E	F	G	H	K	L
1	0	0	0	0	0	0	On	Off	Off	Off	Off	Off	Off	C	0	0	0	0	0
0	1	0	0	0	0	0	Off	On	Off	Off	Off	Off	Off	0	C	0	0	0	0
0	0	1	0	0	0	0	Off	Off	On	Off	Off	Off	Off	0	0	C	0	0	0
0	0	0	1	0	0	0	Off	Off	Off	On	Off	Off	Off	0	0	0	C	0	0
0	0	0	0	1	0	0	Off	Off	Off	Off	On	Off	Off	0	0	0	0	C	0
0	0	0	0	0	1	0	Off	Off	Off	Off	Off	On	Off	0	0	0	0	0	C

TRUTH TABLE Latching CCT-49KX6C-TD

Logic Input			RF Path						Indicator Switches						
1	2	3	J1	J2	J3	J4	J5	J6	Reset	E	F	G	H	K	L
0	0	0	On	Off	Off	Off	Off	Off	Off	C	0	0	0	0	0
1	0	0	Off	On	Off	Off	Off	Off	Off	0	C	0	0	0	0
0	1	0	Off	Off	On	Off	Off	Off	Off	0	0	C	0	0	0
1	1	0	Off	Off	Off	On	Off	Off	Off	0	0	0	C	0	0
0	0	1	Off	Off	Off	Off	On	Off	Off	0	0	0	0	C	0
1	0	1	Off	Off	Off	Off	Off	On	Off	0	0	0	0	0	C
0	1	1	Off	Off	Off	Off	Off	Off	Reset	0	0	0	0	0	0
1	1	1	COIL OFF						0	0	0	0	0	0	

TYPICAL RF PERFORMANCE CURVES

INSERTION LOSS

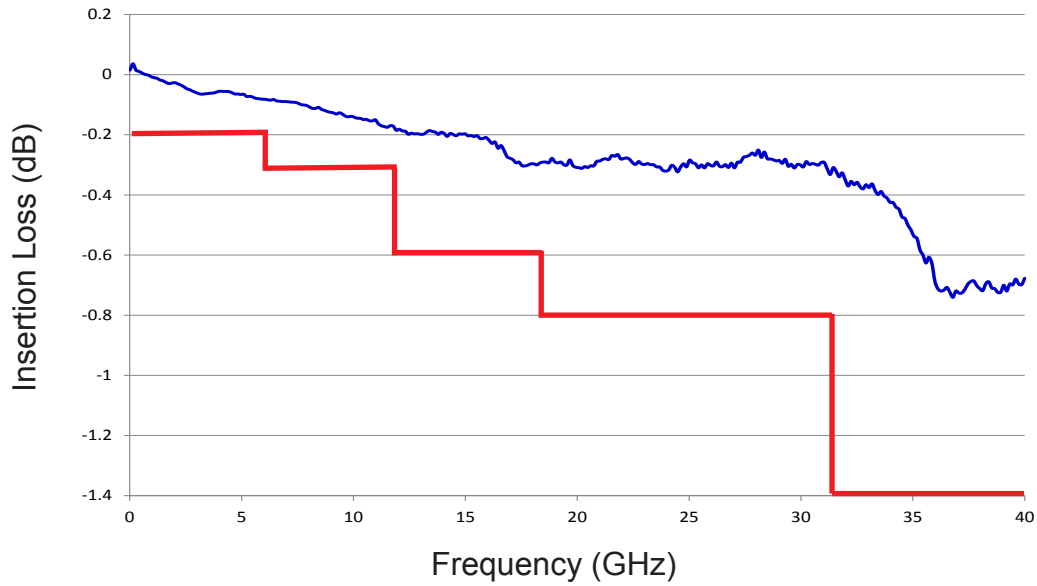

VSWR

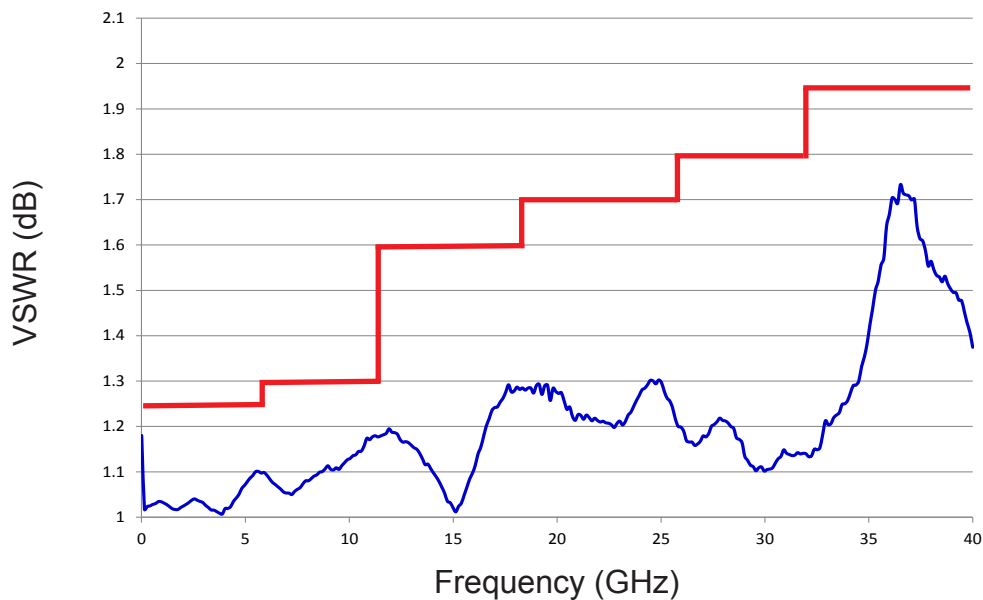

TYPICAL RF PERFORMANCE CURVES

ISOLATION

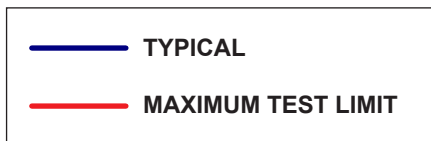
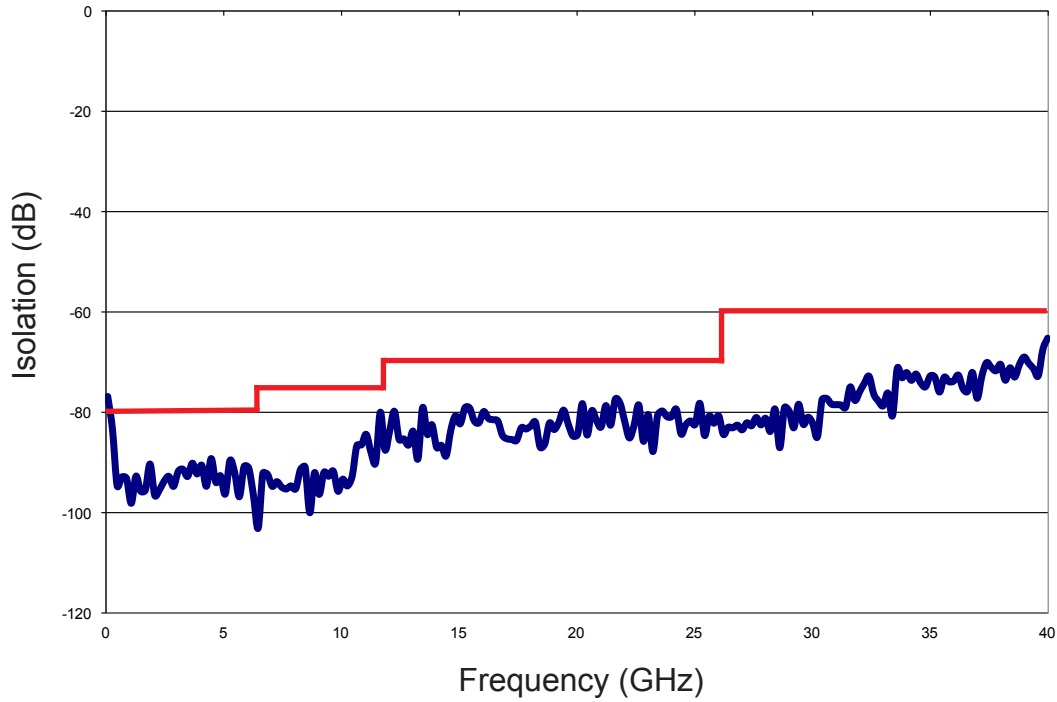

TYPICAL POWER PERFORMANCE CURVE

Power Handling vs. Frequency

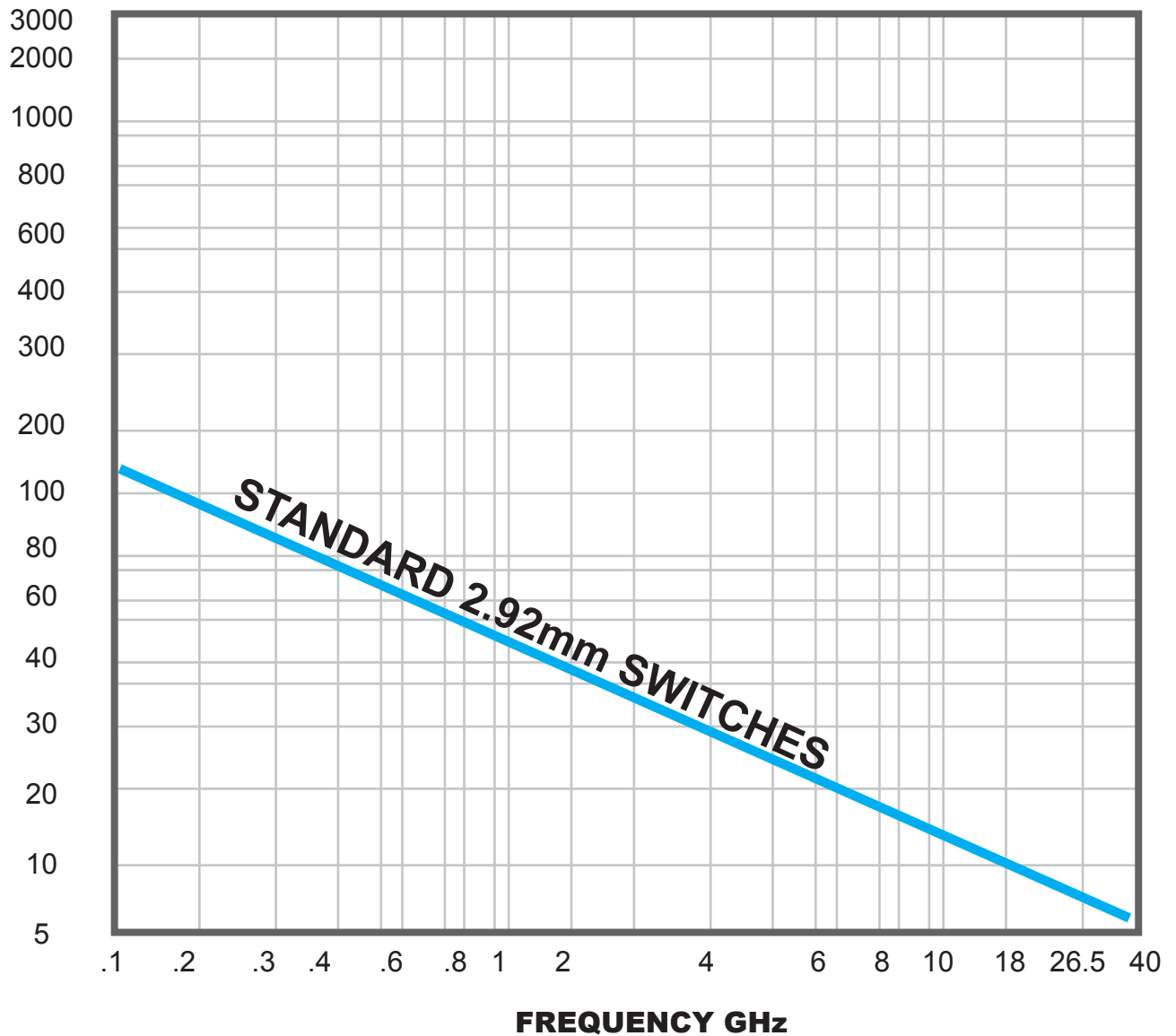

Estimates based on the following reference conditions:

- Ambient temperature of 40°C or less
- Sea level operation
- Load VSWR of 1.20:1 maximum
- No high-power (hot) switching

Please contact Teledyne Coax Switches for derating factors when applications do not meet the foregoing reference conditions.