



CT450

XtremeSense® TMR Contactless Current Sensor with 1 MHz Bandwidth and Programmable Gain

FEATURES

- User Programmable Field Range:
 - 6 mT to 24mT
- Pre-set Magnetic Field Ranges:
 - 0 mT to +6 mT
 - -6 mT to +6 mT
 - 0 mT to +12 mT
 - -12 mT to +12 mT
 - 0 mT to +24 mT
 - -24 mT to +24 mT
- Linear Analog Output Voltage
- 1 MHz Bandwidth
- Response Time < 300 ns
- Reference Voltage Output for Unipolar/Bipolar Field Measurements
- Supply Voltage: 4.75 V to 5.50 V
- Low Noise Performance
- Filter Pin to Reduce Noise on Output
- AEC-Q100 Grade 1
- Package Options:
 - 8-lead SOIC
 - 8-lead TSSOP

APPLICATIONS

- Solar/Power Inverters
- Battery Management Systems
- Industrial Equipment
- Power Utility Meters
- Power Conditioner
- DC/DC Converters

PRODUCT DESCRIPTION

The CT450 is a high bandwidth and low noise integrated contactless current sensor that uses Crocus Technology's patented XtremeSense TMR technology to enable high accuracy current measurements for many consumer, enterprise, and industrial applications. It supports six (6) standard field ranges where the CT450 senses and translates the magnetic field into a linear analog output voltage. It achieves a total error output of less than $\pm 1.0\%$ over voltage and temperature after calibration.

CT450 is also available in a user Programmable variant, which enables end-of-line calibration of gain. While the sensor is pre-programmed to adjust offset and compensate temperature drift. The ability to adjust gain relaxes mechanical tolerances during sensor mounting.

It has less than 300 ns output response time while the current consumption is about 6.0 mA. The CT450 is equipped with a filter function to reduce the noise on the output pin.

The CT450 is housed in an 8-lead SOIC package and a very low profile, industry standard 8-lead TSSOP package that are both "green" and RoHS compliant.

PACKAGE: 8-lead SOIC and 8-lead TSSOP



(Not to Scale)

Part Ordering Information

Part Number	Auto Grade	Range	Operating Temperature Range	Package	Packing Method
Bipolar Sensitivity					
CT450-H06MRSN08	-	±6 mT	-40°C to +125°C	8-lead SOIC 4.89 x 6.00 x 1.62 mm	Tape & Reel
CT450-H12MRSN08	-	±12 mT			
CT450-H24MRSN08	-	±24 mT			
Unipolar Sensitivity					
CT450-H06DRSN08	-	6 mT	-40°C to +125°C	8-lead SOIC 4.89 x 6.00 x 1.62 mm	Tape & Reel
CT450-H12DRSN08	-	12 mT			
CT450-H24DRSN08	-	24 mT			
Programmable Sensitivity					
CT450-H00MRSN08	-	±6mT to ±24mT	-40°C to +125°C	8-lead SOIC 4.89 x 6.00 x 1.62 mm	Tape & Reel
CT450-H00DRSN08		6mT to 24mT			
CT450-H00MRTS08		±6mT to ±24mT		8-lead TSSOP 3.00 x 6.40 x 1.10 mm	
CT450-H00DRTS08		6mT to 24mT			
Programmable Sensitivity – AEC-Q100					
CT450-A00MRSN08	Grade 1	±6mT to ±24mT	-40°C to +125°C	8-lead SOIC 4.89 x 6.00 x 1.62 mm	Tape & Reel
CT450-A00DRSN08		6mT to 24mT			
CT450-A00MRTS08		±6mT to ±24mT		8-lead TSSOP 3.00 x 6.40 x 1.10 mm	
CT450-A00DRTS08		6mT to 24mT			

Evaluation Board Ordering Information

Part Number	Magnetic Field Range	Operating Temperature Range	Package
CTD450-06U	0 mT to +6 mT	-40°C to +125°C	8-lead SOIC 4.89 x 6.00 x 1.62 mm
CTD450-06B	-6 mT to +6 mT		
CTD450-12U	0 mT to +12 mT		
CTD450-12B	-12 mT to +12 mT		
CTD450-24U	0 mT to +24 mT		
CTD450-24B	-24 mT to +24 mT		

Block Diagram

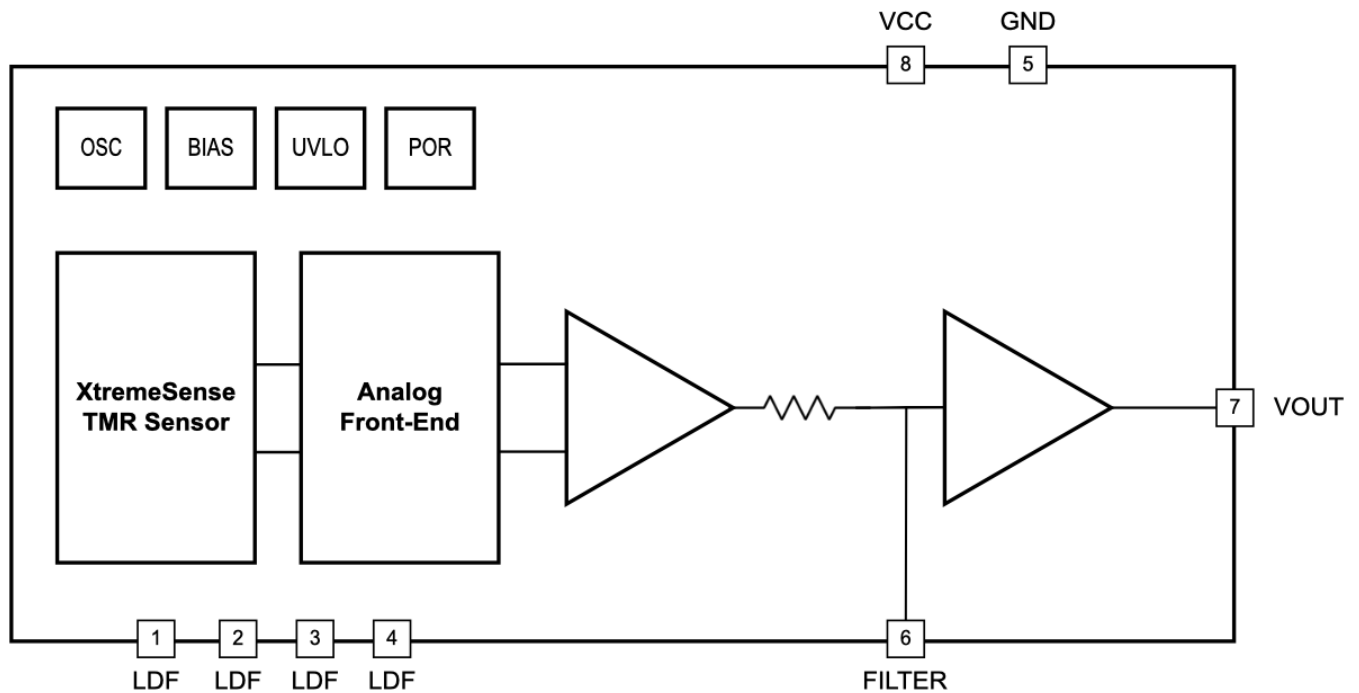

Figure 1. CT450 Functional Block Diagram for SOIC-8

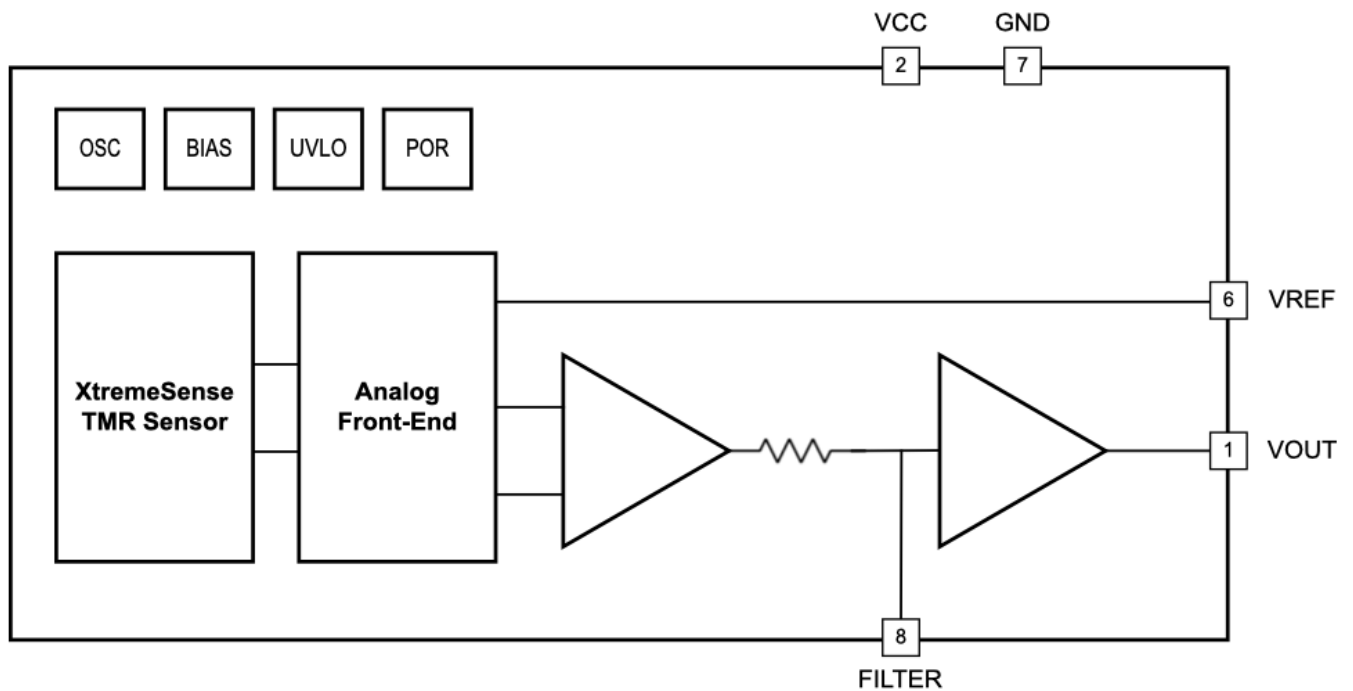

Figure 2. CT450 Functional Block Diagram for TSSOP-8

CT450 Application Diagram

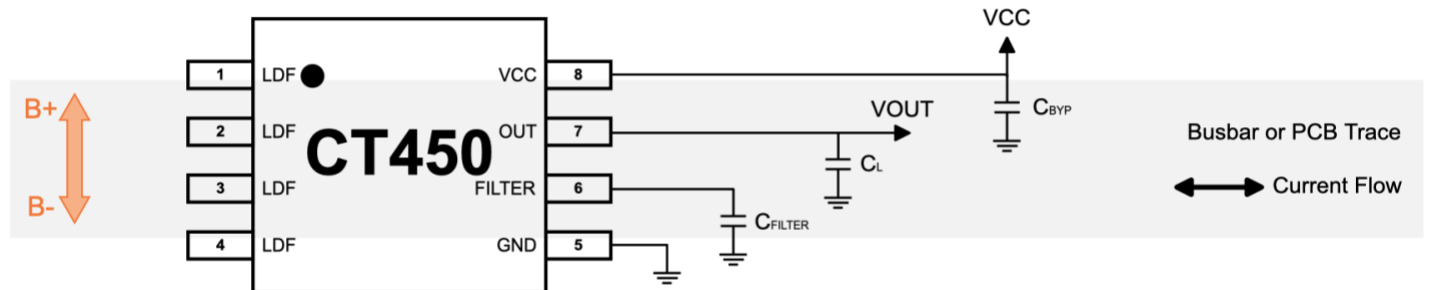

Figure 3. CT450 Application Diagram for SOIC-8

Table 1. Recommended External Components

Component	Description	Vendor & Part Number	Min.	Typ.	Max.	Unit
C_{BYP}	1.0 μF , X5R or Better	Murata GRM155C81A105KA12		1.0		μF
C_{FILTER}	Various, X5R or Better	Murata		Figure 27		pF

CT450 Application Diagram

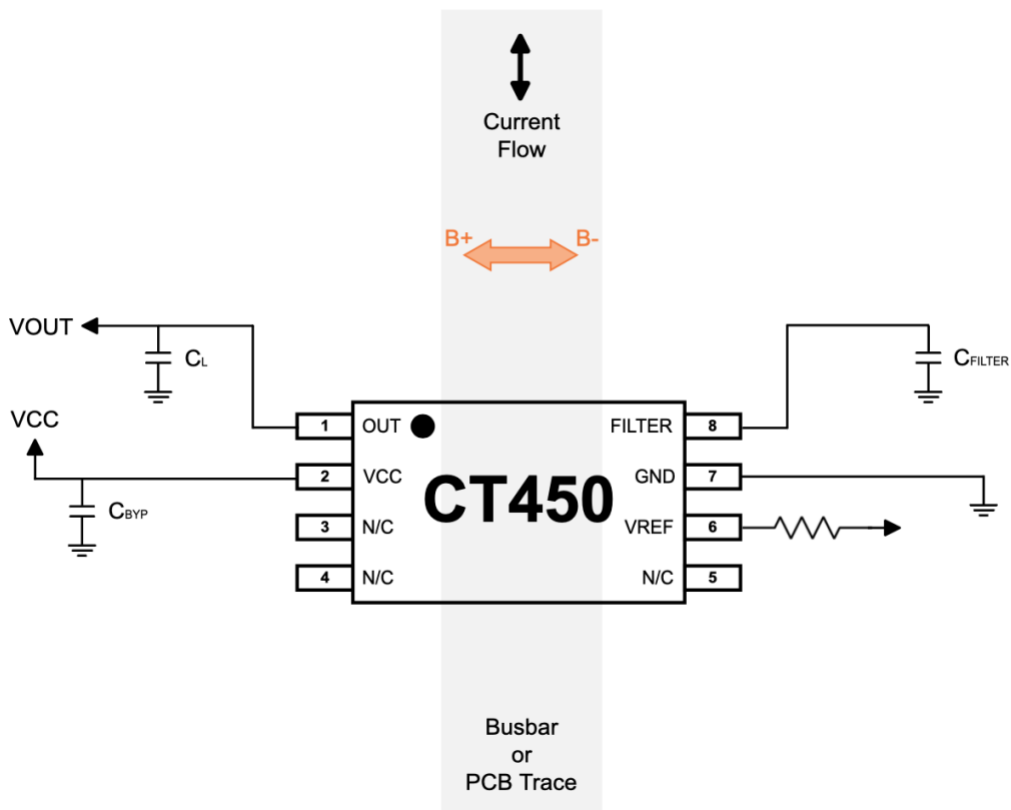

Figure 4. CT450 Application Diagram for TSSOP-8

Table 2. Recommended External Components

Component	Description	Vendor & Part Number	Min.	Typ.	Max.	Unit
C _{BYP}	1.0 μ F, X5R or Better	Murata GRM155C81A105KA12		1.0		μ F
C _{FILTER}	Various, X5R or Better	Murata		Figure 27		pF
R _{VREF}	10 k Ω Resistor	Various		10		k Ω

CT450 SOIC-8 Pin Configuration

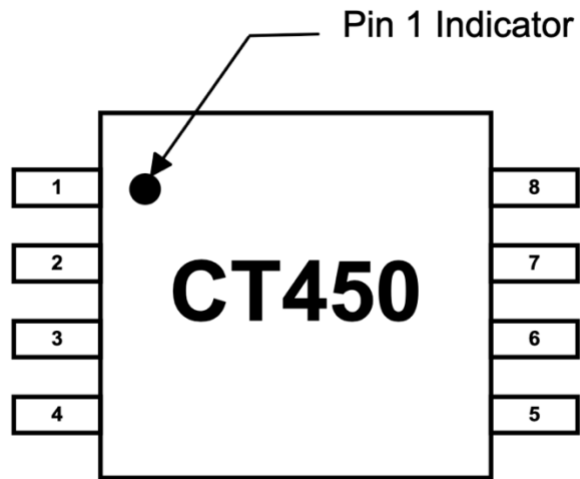

Figure 5. CT450 Pin-out Diagram for 8-lead SOIC Package (Top-Down View)

Pin Definition

Pin #	Pin Name	Pin Description
1	LDF	Lead frame Pin – A single (1) LDF pin should be connected to GND. The other three (3) LDF pins should be left unconnected to avoid ground loops through the lead frame.
2		
3		
4		
5	GND	Ground.
6	FILTER	Filter pin to improve noise performance by connecting an external capacitor to set the cut-off frequency. No connect if the FILTER pin is not used.
7	OUT	Analog output voltage that represents the measured current/field.
8	VCC	Supply voltage.

CT450 TSSOP-8 Pin Configuration

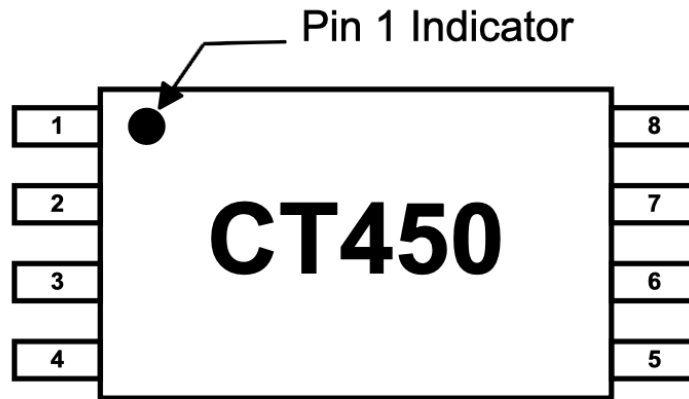

Figure 6. CT450 Pin-out Diagram for 8-lead TSSOP Package (Top-Down View)

Pin Definition

Pin #	Pin Name	Pin Description
1	OUT	Analog output voltage that represents the measured current/field.
2	VCC	Supply voltage.
3	N/C	No connect (Do Not Use).
4		
5		
6	VREF	Reference voltage output. If not used, then do not connect.
7	GND	Ground.
8	FILTER	Filter pin to improve noise performance by connecting an external capacitor to set the cut-off frequency. No connect if the FILTER pin is not used.

Absolute Maximum Ratings

Stresses exceeding the absolute maximum ratings may damage the CT450 and may not function or be operable above the recommended operating conditions and stressing the parts to these levels is not recommended. In addition, extended exposure to stresses above the recommended operating conditions may affect device reliability. The absolute maximum ratings are stress ratings only.

Symbol	Parameter	Min.	Max.	Unit
V_{CC}	Supply Voltage	-0.3	6.0	V
V_{IO}	Analog Input/Output Pins Maximum Voltage	-0.3	$V_{CC} + 0.3^*$	V
ESD	Electrostatic Discharge Protection Level	Human Body Model (HBM) per JESD22-A114	2.0	kV
		Charged Device Model (CDM) per JESD22-C101	0.5	
T_J	Junction Temperature	-40	+150	°C
T_{STG}	Storage Temperature	-65	+155	°C
T_L	Lead Soldering Temperature, 10 Seconds		+260	°C

*The lower of $V_{CC} + 0.3$ V or 6.0 V.

Recommended Operating Conditions

The Recommended Operating Conditions table defines the conditions for actual operation of the CT450. Recommended operating conditions are specified to ensure optimal performance to the specifications. Crocus Technology does not recommend exceeding them or designing to absolute maximum ratings.

Symbol	Parameter	Min.	Typ.	Max.	Unit	
V_{CC}	Supply Voltage Range	4.75	5.00	5.50	V	
V_{OUT}	OUT Voltage Range	0		V_{CC}	V	
I_{OUT}	OUT Current			±1.0	mA	
T_A	Operating Ambient Temperature	Industrial	-40	+25	+85	°C
		Extended Industrial	-40	+25	+125	

Electrical Specifications

General Parameters

Unless otherwise specified: $V_{CC} = 4.75\text{ V to }5.50\text{ V}$, $T_A = -40^\circ\text{C to }+125^\circ\text{C}$, $C_{BYP} = 1.0\ \mu\text{F}$. Typical values are $V_{CC} = 5.00\text{ V}$ and $T_A = +25^\circ\text{C}$.

Symbol	Parameter	Conditions	Min.	Typ.	Max.	Unit
Power Supplies						
I_{CC}	Supply Current	$f_{BW} = 1\text{ MHz}$ No load, $B_{OP} = 0\text{ mT}$		6.0	9.0	mA
I_{OUT}	OUT Maximum Drive Capability	OUT covers 10% to 90% of V_{CC} span.	-1.0		+1.0	mA
C_{L_OUT}	OUT Capacitive Load				100	pF
R_{L_OUT}	OUT Resistive Load			100		k Ω
R_{FILTER}	Internal Filter Resistance ⁽¹⁾			15		k Ω
PSRR	Power Supply Rejection Ratio ⁽¹⁾			35		dB
SPSRR	Sensitivity Power Supply (PS) Rejection Ratio ⁽¹⁾			35		dB
OPSRR	Offset PS Rejection Ratio ⁽¹⁾			40		dB
Analog Output (OUT)						
V_{OUT}	OUT Voltage Linear Range	$V_{SIG_AC} = \pm 2.00\text{ V}$ $V_{SIG_DC} = +4.00\text{ V}$	0.50		4.50	V
V_{OUT_SAT}	Output High Saturation Voltage	$T_A = +25^\circ\text{C}$	$V_{CC} - 0.30$	$V_{CC} - 0.25$		V
Reference Voltage (VREF) for TSSOP-8 Only						
V_{REF}	Reference Voltage	Unipolar Version		0.50		V
		Bipolar Version		2.50		
I_{VREF}	V_{REF} Maximum Drive Capability	TSSOP-8 version only	-50		+50	μA
C_{L_VREF}	V_{REF} Capacitive Load	TSSOP-8 version only			10	pF
R_{L_VREF}	V_{REF} Resistive Load	TSSOP-8 version only		10		k Ω
Timings						
t_{ON}	Power-On Time	$V_{CC} \geq 4.0\text{ V}$		100	200	μs
t_{RISE}	Rise Time ⁽¹⁾	$B_{OP} = B_{OP(MAX)}$, $T_A = +25^\circ\text{C}$, $C_L = 100\text{ pF}$		200		ns
$t_{RESPONSE}$	Response Time ⁽¹⁾			300		ns
t_{DELAY}	Propagation Delay ⁽¹⁾			250		ns
Protection						
V_{UVLO}	Under-Voltage Lockout	Rising V_{CC}		2.50		V
		Falling V_{CC}		2.45		V
V_{UV_HYS}	UVLO Hysteresis			50		mV

(1) Guaranteed by design and characterization; not tested in production.

Electrical Characteristics

$V_{CC} = 5.00\text{ V}$ and $T_A = +25^\circ\text{C}$ and $C_{BYP} = 1.0\ \mu\text{F}$ (unless otherwise specified)

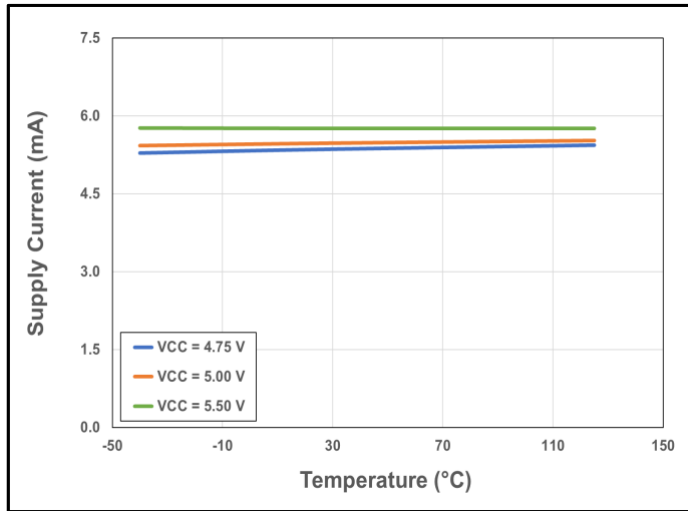

Figure 7. CT450 Supply Current vs. Temperature vs. Supply Voltage

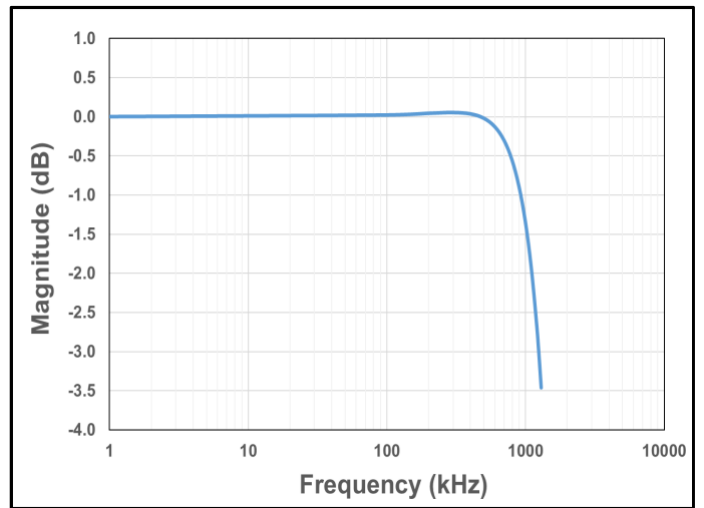

Figure 8. CT450 Bandwidth with $C_{FILTER} = 1.0\ \text{pF}$

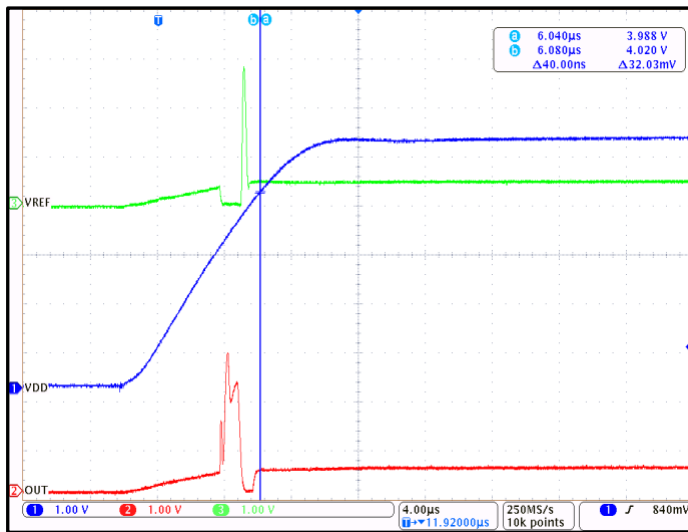

Figure 9. CT450 Startup Waveforms for $V_{OQ} = 0.50\text{ V}$ (Unipolar Sensor Version)

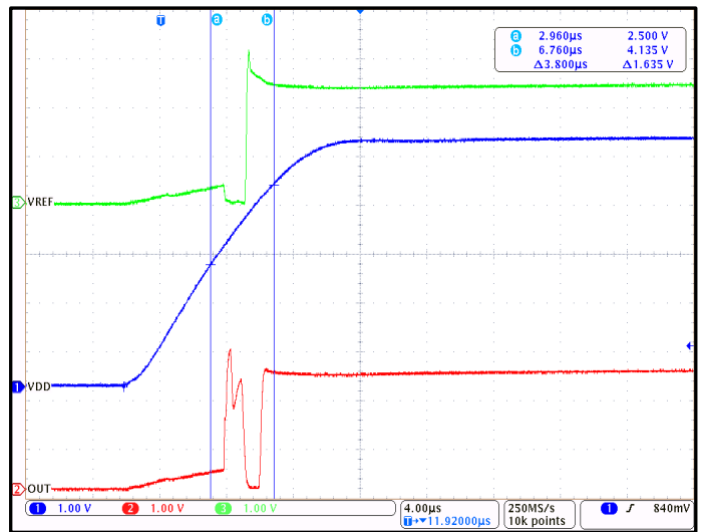

Figure 10. CT450 Startup Waveforms for $V_{OQ} = 2.50\text{ V}$ (Bipolar Sensor Version)

Electrical Characteristics (continued)

$V_{CC} = 5.00\text{ V}$ and $T_A = +25^\circ\text{C}$ and $C_{BYP} = 1.0\ \mu\text{F}$ (unless otherwise specified)

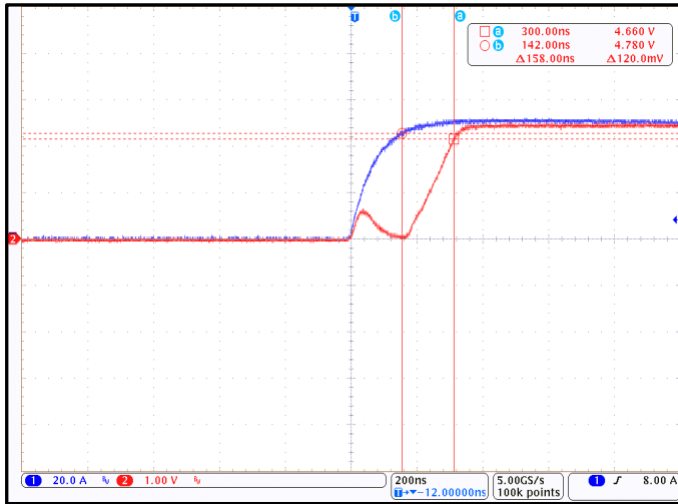

Figure 11. CT450 Response Time; $B_{OP} = 12\text{ mT}$ and $C_L = 100\text{ pF}$ (Blue = B Field, Red = V_{OUT})

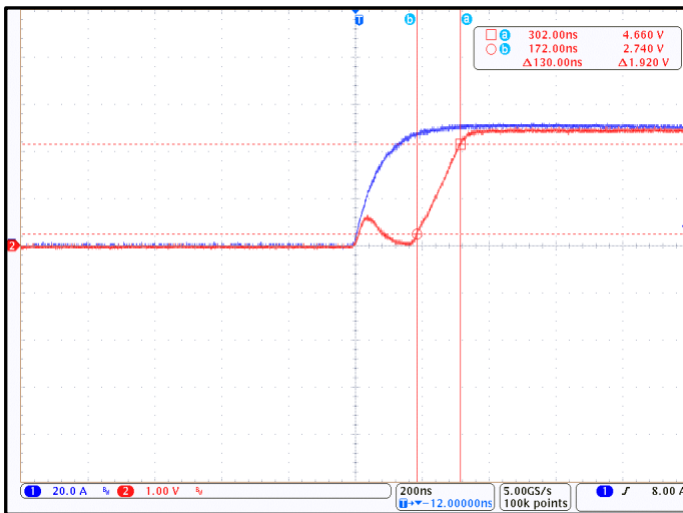

Figure 12. CT450 Rise Time; $B_{OP} = 12\text{ mT}$ and $C_L = 100\text{ pF}$ (Blue = B Field, Red = V_{OUT})

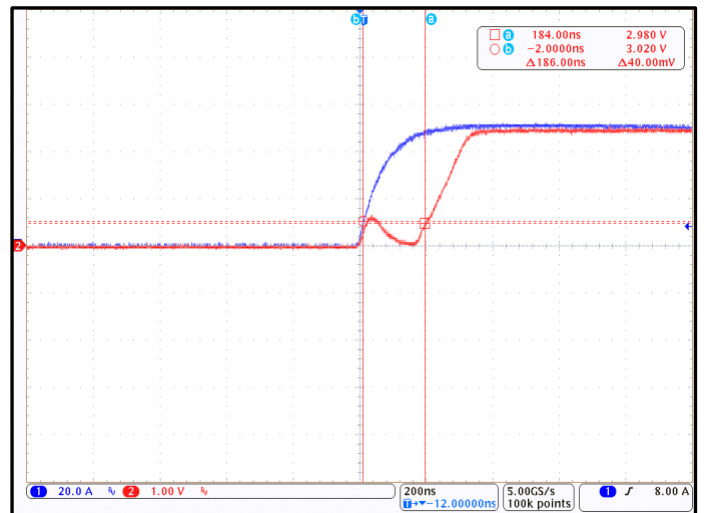

Figure 13. CT450 Propagation Delay; $B_{OP} = 12\text{ mT}$ and $C_L = 100\text{ pF}$ (Blue = B Field, Red = V_{OUT})

CT450-x06DR: 0 mT to +6 mT

Unless otherwise specified: $V_{CC} = 4.75\text{ V to }5.50\text{ V}$, $T_A = -40^\circ\text{C to }+125^\circ\text{C}$, $C_{BYP} = 1.0\ \mu\text{F}$. Typical values are $V_{CC} = 5.00\text{ V}$ and $T_A = +25^\circ\text{C}$.

Symbol	Parameter	Conditions	Min.	Typ.	Max.	Unit
B_{RNG}	Magnetic Field Range		0		+6	mT
V_{OQ}	Voltage Output Quiescent	$T_A = +25^\circ\text{C}$, $B_{OP} = 0\text{ mT}$	0.495	0.500	0.505	V
S	Sensitivity	$B_{RNG(MIN)} < B_{OP} < B_{RNG(MAX)}$		666.7		mV/mT
f_{BW}	Bandwidth ⁽¹⁾	Small Signal = -3 dB		1.0		MHz
e_N	Noise ⁽¹⁾	$T_A = +25^\circ\text{C}$, $f_{BW} = 100\text{ kHz}$		1.63		mV _{RMS}
				2.45		μT_{RMS}
OUT Accuracy Performance						
E_{LIN}	Non-Linearity Error ⁽¹⁾			± 0.2		% FS
E_{SENS}	Sensitivity Error ⁽¹⁾			± 0.3		% FS
V_{OFFSET}	Offset Voltage ⁽¹⁾	$B_{OP} = 0\text{ mT}$		± 10.0		mV
				± 0.3		% FS
Lifetime Drift						
E_{TOT_DRIFT}	Total Output Error Lifetime Drift ⁽¹⁾			± 1.0		% FS

(1) Guaranteed by design and characterization; not tested in production.

Electrical Characteristics for CT450-x06DR

$V_{CC} = 5.0\text{ V}$ and $T_A = +25^\circ\text{C}$ and $C_{BYP} = 1.0\ \mu\text{F}$ (unless otherwise specified)

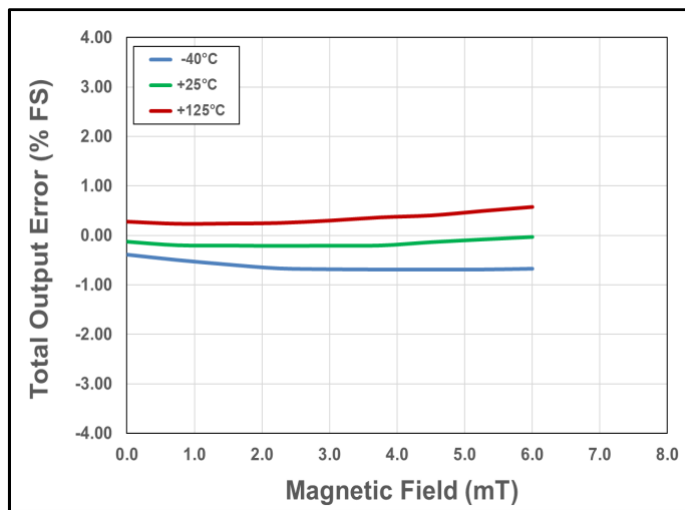

Figure 14. Total Output Error vs. B Field vs. Temperature

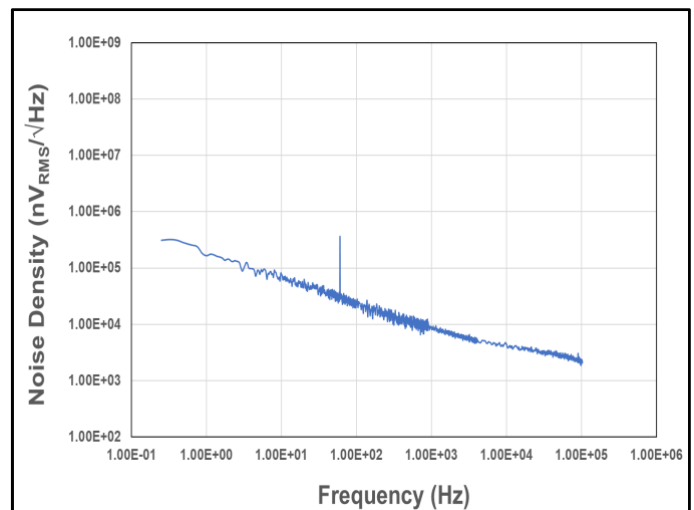

Figure 15. Noise Density vs. Frequency

CT450-x06MR: -6 mT to +6 mT

Unless otherwise specified: $V_{CC} = 4.75\text{ V to }5.50\text{ V}$, $T_A = -40^\circ\text{C to }+125^\circ\text{C}$, $C_{BYP} = 1.0\ \mu\text{F}$. Typical values are $V_{CC} = 5.00\text{ V}$ and $T_A = +25^\circ\text{C}$.

Symbol	Parameter	Conditions	Min.	Typ.	Max.	Unit
B _{RNG}	Magnetic Field Range		-6		+6	mT
V _{OQ}	Voltage Output Quiescent	T _A = +25°C, B _{OP} = 0 mT	2.490	2.500	2.510	V
S	Sensitivity	B _{RNG(MIN)} < B _{OP} < B _{RNG(MAX)}		333.3		mV/mT
f _{BW}	Bandwidth ⁽¹⁾	Small Signal = -3 dB		1.0		MHz
e _N	Noise ⁽¹⁾	T _A = +25°C, f _{BW} = 100 kHz		0.92		mV _{RMS}
				2.77		μT _{RMS}
OUT Accuracy Performance						
E _{LIN}	Non-Linearity Error ⁽¹⁾			±0.1		% FS
E _{SENS}	Sensitivity Error ⁽¹⁾			±0.3		% FS
V _{OFFSET}	Offset Voltage ⁽¹⁾	B _{OP} = 0 mT		±8.0		mV
				±0.2		% FS
Lifetime Drift						
E _{TOT_DRIFT}	Total Output Error Lifetime Drift ⁽¹⁾			±1.0		% FS

(1) Guaranteed by design and characterization; not tested in production.

Electrical Characteristics for CT450-x06MR

$V_{CC} = 5.0\text{ V}$ and $T_A = +25^\circ\text{C}$ and $C_{BYP} = 1.0\ \mu\text{F}$ (unless otherwise specified)

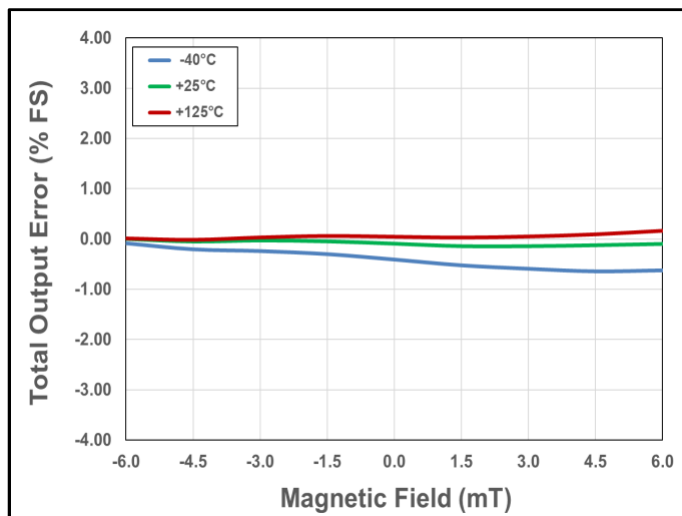

Figure 16. Total Output Error vs. B Field vs. Temperature

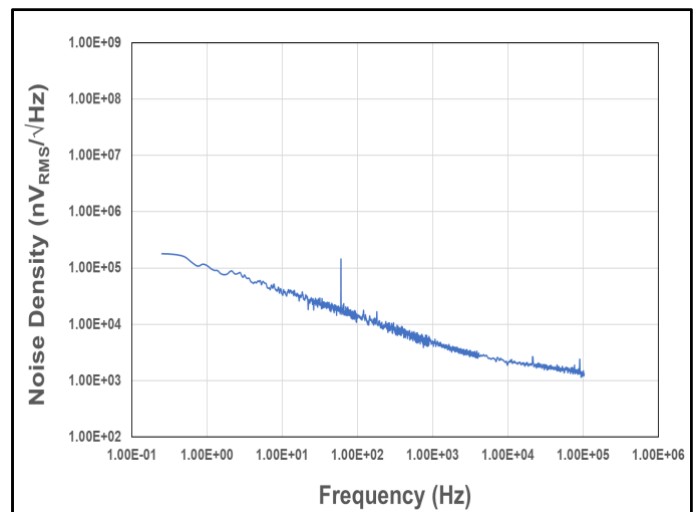

Figure 17. Noise Density vs. Frequency

CT450-x12DR: 0 mT to +12 mT

Unless otherwise specified: $V_{CC} = 4.75\text{ V to }5.50\text{ V}$, $T_A = -40^\circ\text{C to }+125^\circ\text{C}$, $C_{BYP} = 1.0\ \mu\text{F}$. Typical values are $V_{CC} = 5.00\text{ V}$ and $T_A = +25^\circ\text{C}$.

Symbol	Parameter	Conditions	Min.	Typ.	Max.	Unit
B_{RNG}	Magnetic Field Range		0		+12	mT
V_{OQ}	Voltage Output Quiescent	$T_A = +25^\circ\text{C}$, $B_{OP} = 0\text{ mT}$	0.495	0.500	0.505	V
S	Sensitivity	$B_{RNG(MIN)} < B_{OP} < B_{RNG(MAX)}$		333.3		mV/mT
f_{BW}	Bandwidth ⁽¹⁾	Small Signal = -3 dB		1.0		MHz
e_N	Noise ⁽¹⁾	$T_A = +25^\circ\text{C}$, $f_{BW} = 100\text{ kHz}$		1.30		mV _{RMS}
				3.90		μT_{RMS}
OUT Accuracy Performance						
E_{LIN}	Non-Linearity Error ⁽¹⁾			± 0.2		% FS
E_{SENS}	Sensitivity Error ⁽¹⁾			± 0.3		% FS
V_{OFFSET}	Offset Voltage ⁽¹⁾	$B_{OP} = 0\text{ mT}$		± 9.0		mV
				± 0.2		% FS
Lifetime Drift						
E_{TOT_DRIFT}	Total Output Error Lifetime Drift ⁽¹⁾			± 1.0		% FS

(1) Guaranteed by design and characterization; not tested in production.

Electrical Characteristics for CT450-x12DR

$V_{CC} = 5.0\text{ V}$ and $T_A = +25^\circ\text{C}$ and $C_{BYP} = 1.0\ \mu\text{F}$ (unless otherwise specified)

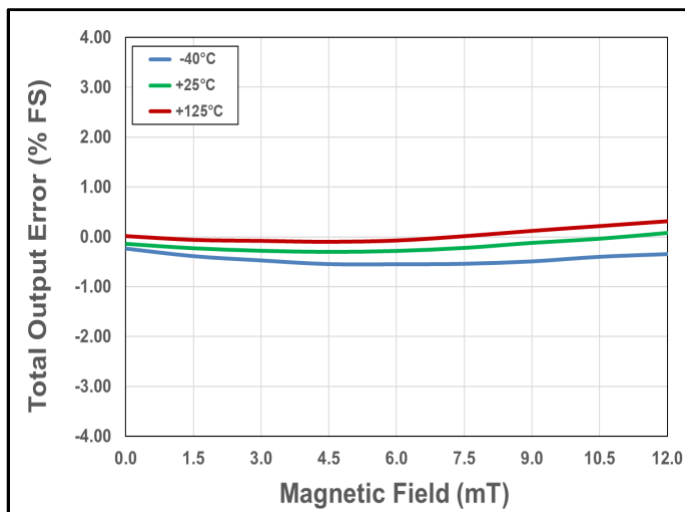

Figure 18. Total Output Error vs. B Field vs. Temperature

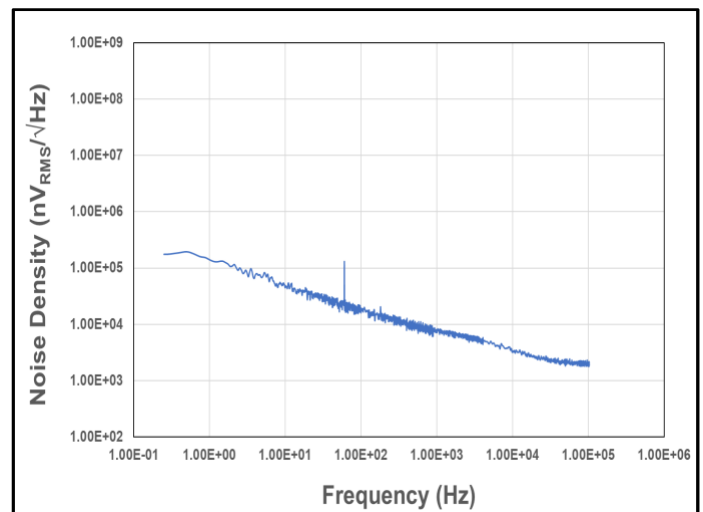

Figure 19. Noise Density vs. Frequency

CT450-x12MR: -12 mT to +12 mT

Unless otherwise specified: $V_{CC} = 4.75\text{ V to }5.50\text{ V}$, $T_A = -40^\circ\text{C to }+125^\circ\text{C}$, $C_{BYP} = 1.0\ \mu\text{F}$. Typical values are $V_{CC} = 5.00\text{ V}$ and $T_A = +25^\circ\text{C}$.

Symbol	Parameter	Conditions	Min.	Typ.	Max.	Unit
B_{RNG}	Magnetic Field Range		-12		+12	mT
V_{OQ}	Voltage Output Quiescent	$T_A = +25^\circ\text{C}$, $B_{OP} = 0\text{ mT}$	2.490	2.500	2.510	V
S	Sensitivity	$B_{RNG(MIN)} < B_{OP} < B_{RNG(MAX)}$		166.7		mV/mT
f_{BW}	Bandwidth ⁽¹⁾	Small Signal = -3 dB		1.0		MHz
e_N	Noise ⁽¹⁾	$T_A = +25^\circ\text{C}$, $f_{BW} = 100\text{ kHz}$		0.75		mV _{RMS}
				4.50		μT_{RMS}
OUT Accuracy Performance						
E_{LIN}	Non-Linearity Error ⁽¹⁾			± 0.1		% FS
E_{SENS}	Sensitivity Error ⁽¹⁾			± 0.3		% FS
V_{OFFSET}	Offset Voltage ⁽¹⁾	$B_{OP} = 0\text{ mT}$		± 7.0		mV
				± 0.2		% FS
Lifetime Drift						
E_{TOT_DRIFT}	Total Output Error Lifetime Drift ⁽¹⁾			± 1.0		% FS

(1) Guaranteed by design and characterization; not tested in production.

Electrical Characteristics for CT450-x12MR

$V_{CC} = 5.0\text{ V}$ and $T_A = +25^\circ\text{C}$ and $C_{BYP} = 1.0\ \mu\text{F}$ (unless otherwise specified)

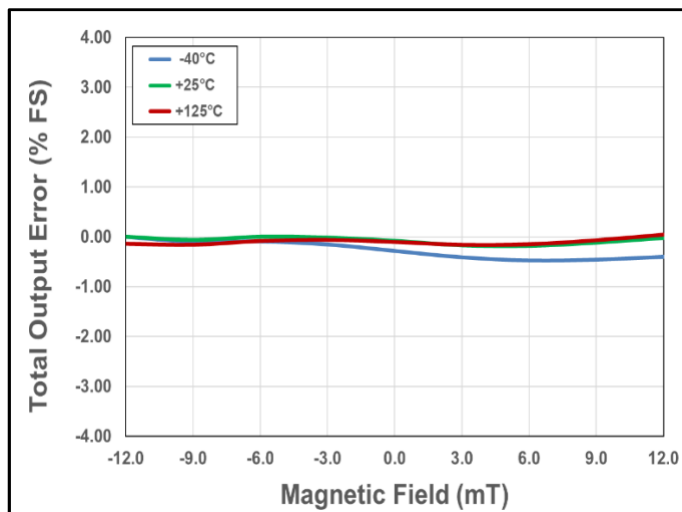

Figure 20. Total Output Error vs. B Field vs. Temperature

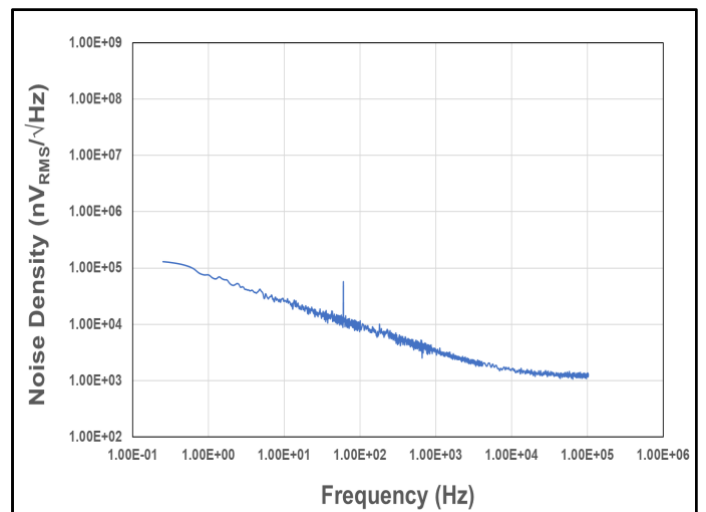

Figure 21. Noise Density vs. Frequency

CT450-x24DR: 0 mT to +24 mT

Unless otherwise specified: $V_{CC} = 4.75\text{ V to }5.50\text{ V}$, $T_A = -40^\circ\text{C to }+125^\circ\text{C}$, $C_{BYP} = 1.0\ \mu\text{F}$. Typical values are $V_{CC} = 5.00\text{ V}$ and $T_A = +25^\circ\text{C}$.

Symbol	Parameter	Conditions	Min.	Typ.	Max.	Unit
B_{RNG}	Magnetic Field Range		0		+24	mT
V_{OQ}	Voltage Output Quiescent	$T_A = +25^\circ\text{C}$, $B_{OP} = 0\text{ mT}$	0.495	0.500	0.505	V
S	Sensitivity	$B_{RNG(MIN)} < B_{OP} < B_{RNG(MAX)}$		166.7		mV/mT
f_{BW}	Bandwidth ⁽¹⁾	Small Signal = -3 dB		1.0		MHz
e_N	Noise ⁽¹⁾	$T_A = +25^\circ\text{C}$, $f_{BW} = 100\text{ kHz}$		0.46		mV _{RMS}
				2.77		μT_{RMS}
OUT Accuracy Performance						
E_{LIN}	Non-Linearity Error ⁽¹⁾			± 0.3		% FS
E_{SENS}	Sensitivity Error ⁽¹⁾			± 0.3		% FS
V_{OFFSET}	Offset Voltage ⁽¹⁾	$B_{OP} = 0\text{ mT}$		± 8.0		mV
				± 0.2		% FS
Lifetime Drift						
E_{TOT_DRIFT}	Total Output Error Lifetime Drift ⁽¹⁾			± 1.0		% FS

(1) Guaranteed by design and characterization; not tested in production.

Electrical Characteristics for CT450-x24DR

$V_{CC} = 5.0\text{ V}$ and $T_A = +25^\circ\text{C}$ and $C_{BYP} = 1.0\ \mu\text{F}$ (unless otherwise specified)

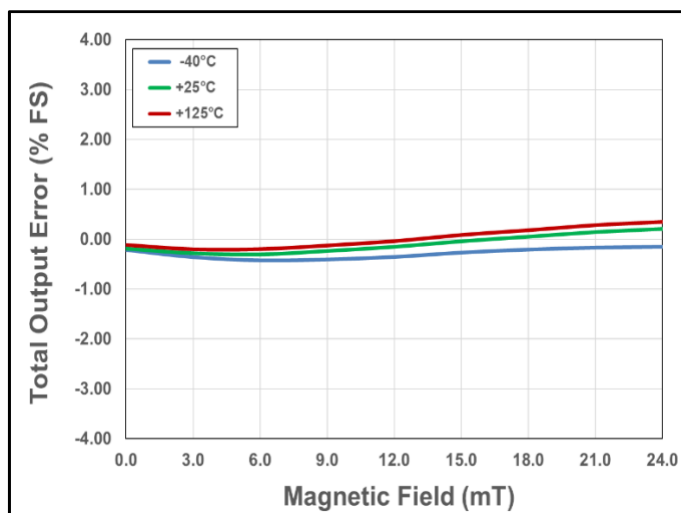

Figure 22. Total Output Error vs. B Field vs. Temperature

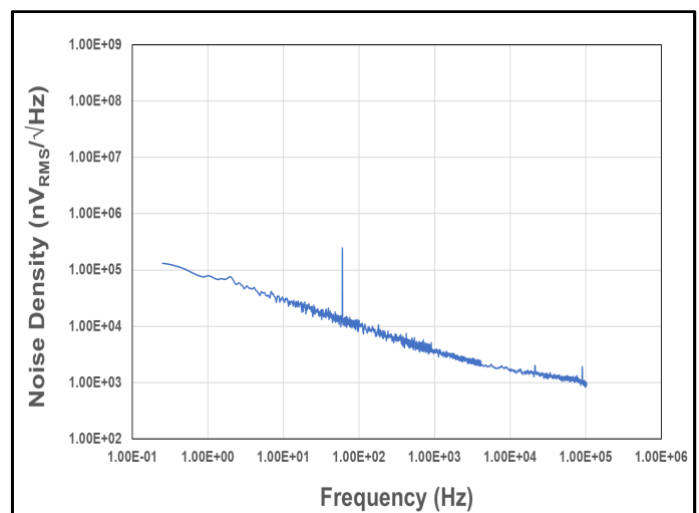

Figure 23. Noise Density vs. Frequency

CT450-x24MR: -24 mT to +24 mT

Unless otherwise specified: $V_{CC} = 4.75\text{ V to }5.50\text{ V}$, $T_A = -40^\circ\text{C to }+125^\circ\text{C}$, $C_{BYP} = 1.0\ \mu\text{F}$. Typical values are $V_{CC} = 5.00\text{ V}$ and $T_A = +25^\circ\text{C}$.

Symbol	Parameter	Conditions	Min.	Typ.	Max.	Unit
B _{RNG}	Magnetic Field Range		-24		+24	mT
V _{OQ}	Voltage Output Quiescent	T _A = +25°C, B _{OP} = 0 mT	2.490	2.500	2.510	V
S	Sensitivity	B _{RNG(MIN)} < B _{OP} < B _{RNG(MAX)}		83.3		mV/mT
f _{BW}	Bandwidth ⁽¹⁾	Small Signal = -3 dB		1.0		MHz
e _N	Noise ⁽¹⁾	T _A = +25°C, f _{BW} = 100 kHz		0.38		mV _{RMS}
				4.56		μT _{RMS}
OUT Accuracy Performance						
E _{LIN}	Non-Linearity Error ⁽¹⁾			±0.2		% FS
E _{SENS}	Sensitivity Error ⁽¹⁾			±0.3		% FS
V _{OFFSET}	Offset Voltage ⁽¹⁾	B _{OP} = 0 mT		±7.0		mV
				±0.2		% FS
Lifetime Drift						
E _{TOT_DRIFT}	Total Output Error Lifetime Drift ⁽¹⁾			±1.0		% FS

(1) Guaranteed by design and characterization; not tested in production.

Electrical Characteristics for CT450-x24MR

$V_{CC} = 5.0\text{ V}$ and $T_A = +25^\circ\text{C}$ and $C_{BYP} = 1.0\ \mu\text{F}$ (unless otherwise specified)

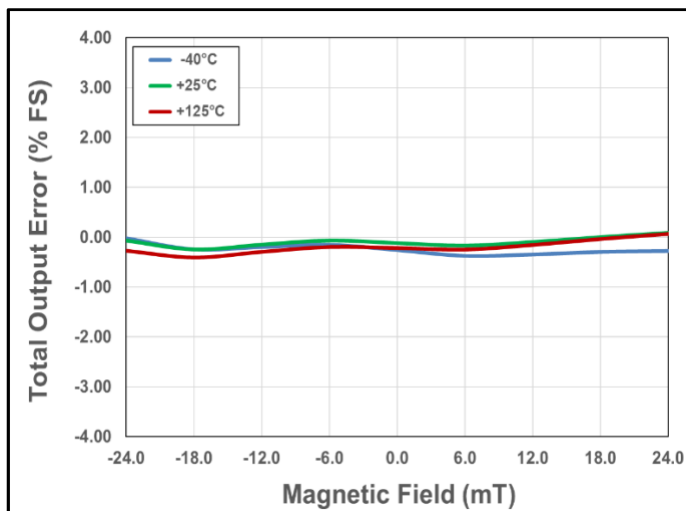

Figure 24. Total Output Error vs. B Field vs. Temperature

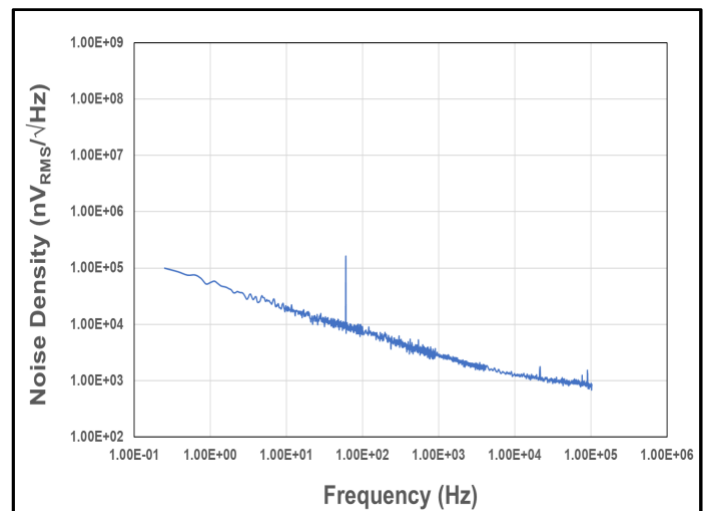

Figure 25. Noise Density vs. Frequency

CT450-x00MR: Programmable Gain

Unless otherwise specified: $V_{CC} = 4.75\text{ V to }5.50\text{ V}$, $T_A = -40^\circ\text{C to }+125^\circ\text{C}$, $C_{BYP} = 1.0\ \mu\text{F}$. Typical values are $V_{CC} = 5.00\text{ V}$ and $T_A = +25^\circ\text{C}$.

Symbol	Parameter	Conditions	Min.	Typ.	Max.	Unit
B_{PRNG}	Programmable Magnetic Field Range		± 6		± 24	mT
V_{OQ}	Voltage Output Quiescent	$T_A = +25^\circ\text{C}$, $B_{OP} = 0\text{ mT}$	2.490	2.500	2.510	V
S	Sensitivity	$B_{RNG(MIN)} < B_{OP} < B_{RNG(MAX)}$	83.4		333.3	mV/mT
f_{BW}	Bandwidth ⁽¹⁾	Small Signal = -3 dB		1.0		MHz
e_N	Noise ⁽¹⁾	$T_A = +25^\circ\text{C}$, $f_{BW} = 100\text{ kHz}$	0.38	-	0.92	mV _{RMS}
			2.77	-	4.56	μT_{RMS}
OUT Accuracy Performance						
E_{LIN}	Non-Linearity Error ⁽¹⁾			± 0.2		% FS
E_{SENS}	Sensitivity Error ⁽¹⁾			± 0.3		% FS
V_{OFFSET}	Offset Voltage ⁽¹⁾	$B_{OP} = 0\text{ mT}$	± 7.0	-	± 8.0	mV
			± 0.2	-	± 0.2	% FS
Lifetime Drift						
E_{TOT_DRIFT}	Total Output Error Lifetime Drift ⁽¹⁾			± 1.0		% FS

(2) Guaranteed by design and characterization; not tested in production.

Calibration Description

CT450-x00MR is factory trimmed for sensitivity and offset temperature drift. The sensor provides the ability to adjust gain to allow for all the mechanical tolerances during manufacturing. Gain calibration is recommended to be performed at room-temperature (25°C) using Crocus Technology's CTC4000 Calibration Box.

CT450-x00DR: Programmable Gain

Unless otherwise specified: $V_{CC} = 4.75\text{ V to }5.50\text{ V}$, $T_A = -40^\circ\text{C to }+125^\circ\text{C}$, $C_{BYP} = 1.0\ \mu\text{F}$. Typical values are $V_{CC} = 5.00\text{ V}$ and $T_A = +25^\circ\text{C}$.

Symbol	Parameter	Conditions	Min.	Typ.	Max.	Unit
B_{PRNG}	Programmable Magnetic Field Range		6		24	mT
V_{OQ}	Voltage Output Quiescent	$T_A = +25^\circ\text{C}$, $B_{OP} = 0\text{ mT}$	0.495	0.500	0.505	V
S	Sensitivity	$B_{RNG(MIN)} < B_{OP} < B_{RNG(MAX)}$	166.7		666.7	mV/mT
f_{BW}	Bandwidth ⁽¹⁾	Small Signal = -3 dB		1.0		MHz
e_N	Noise ⁽¹⁾	$T_A = +25^\circ\text{C}$, $f_{BW} = 100\text{ kHz}$	0.46	-	1.63	mV _{RMS}
			2.45	-	2.77	μT_{RMS}
OUT Accuracy Performance						
E_{LIN}	Non-Linearity Error ⁽¹⁾			± 0.3		% FS
E_{SENS}	Sensitivity Error ⁽¹⁾			± 0.3		% FS
V_{OFFSET}	Offset Voltage ⁽¹⁾	$B_{OP} = 0\text{ mT}$	± 8.0	-	± 10.0	mV
			± 0.2	-	± 0.3	% FS
Lifetime Drift						
E_{TOT_DRIFT}	Total Output Error Lifetime Drift ⁽¹⁾			± 1.0		% FS

(3) Guaranteed by design and characterization; not tested in production.

Calibration Description

CT450-x00DR is factory trimmed for sensitivity and offset temperature drift. The sensor provides the ability to adjust gain to allow for all the mechanical tolerances during manufacturing. Gain calibration is recommended to be performed at room-temperature (25°C) using Crocus Technology's CTC4000 Calibration Box.

Circuit Description

The CT450 is a very high accuracy contactless current sensor that can sense magnetic fields from 6 mT to 24 mT. It has very high sensitivity and a wide dynamic range with excellent accuracy (very low total output error) across temperature. This current sensor supports six (6) field ranges as standard and can also be user-programmable:

- 0 mT to +6 mT
- -6 mT to +6 mT
- 0 mT to +12 mT
- -12 mT to +12 mT
- 0 mT to 24 mT
- -24 mT to +24 mT

CT450 is also available in a user-programmable variant which enables end-of-line calibration of gain. While the sensor is pre-programmed to adjust sensitivity and offset temperature drift. The ability to adjust gain relaxes mechanical tolerances during sensor mounting.

When current is flowing through a busbar above or below the CT450, the XtremeSense TMR sensor inside the chip senses the field which in turn generates a differential voltage signals that then goes through the Analog Front-End (AFE) to output a current measurement as low as $\pm 1.0\%$ full-scale (FS) total output error (E_{OUT}).

The chip is designed to enable a very fast response time of 300 ns for the current measurement from the OUT pin as the bandwidth for the CT450 is 1.0 MHz. Even with a high bandwidth, the chip consumes a minimal amount of power.

Linear Output Magnetic Field Measurement

The CT450 provides a continuous linear analog output voltage which represents the magnetic field generated by the current flowing through the busbar. The output voltage range of OUT is from 0.50 V to 4.50 V with a V_{OQ} of 0.50 V and 2.50 V for unidirectional and bidirectional fields, respectively. Figure 26 illustrates the output voltage range of the OUT pin as a function of the measured field.

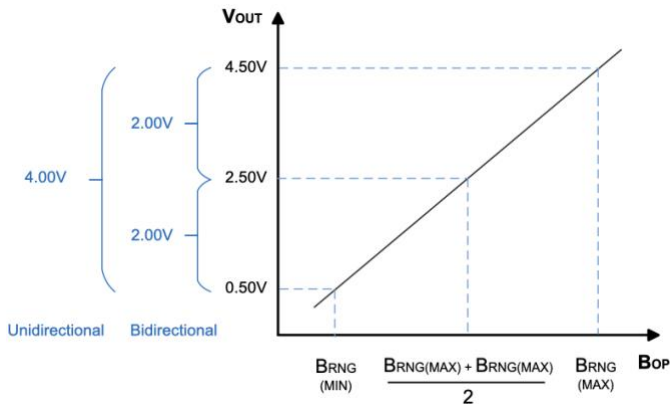

Figure 26. Linear Output Voltage Range (OUT) vs. Measured Magnetic Field (B_{OP})

Voltage Reference Function (VREF)

The CT450 in TSSOP-8 package has a reference voltage (V_{REF}) pin that may be used as an output voltage reference for AC or DC field/current measurements. The V_{REF} pin should be connected to a buffer circuit.

If the V_{REF} is not used, then it should be left unconnected.

Filter Function (FILTER)

The CT450 in both packages has a pin for the FILTER function which will enable it to improve the noise performance by changing the cut-off frequency. The bandwidth of the CT450 is 1.0 MHz, however by adding a capacitor to the FILTER pin which, will be in series with an internal resistance of approximately 15 k Ω , will set the cut-off frequency to reduce the noise. Figure 27 shows the capacitor values required to achieve different cut-off frequencies.

Experimentally measured bandwidth does not necessarily match the calculated bandwidth value by using the equation $f_{BW} = 1/2\pi RC$ because of the parasitic capacitances due to PCB manufacturing and layout. This is further impacted by the small, pico-Farad level C_{FILTER} recommendations.

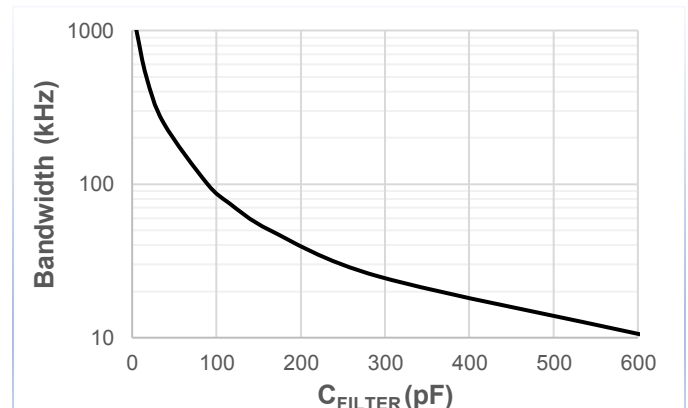

Figure 27 Bandwidth vs. C_{FILTER}

Total Output Error

The Total Output Error is the difference between the magnetic field measured by CT450 and the actual field, relative to the actual field. It is equivalent to the ratio between the difference of the ideal and measured voltage to the ideal sensitivity multiplied by the magnetic field due to current flowing through the busbar. The equation below defines the Total Output Error (E_{OUT}) for the CT450:

$$E_{OUT} = 100 * \frac{V_{OUT_IDEAL}(B_{OP}) - V_{OUT}(B_{OP})}{S_{IDEAL} \times B_{OP}(FS)}$$

The E_{OUT} incorporates all sources of error and is a function of the sensed magnetic field (B_{OP}) from CT450. At high field levels, the E_{OUT} will be dominated by the sensitivity error whereas at low fields, the dominant characteristic is the offset voltage. Figure 28 shows the behavior of E_{OUT} versus B_{OP} . When B_{OP} goes 0 from both directions, the curves exhibit asymptotic behavior (i.e. E_{OUT} approaches infinity).

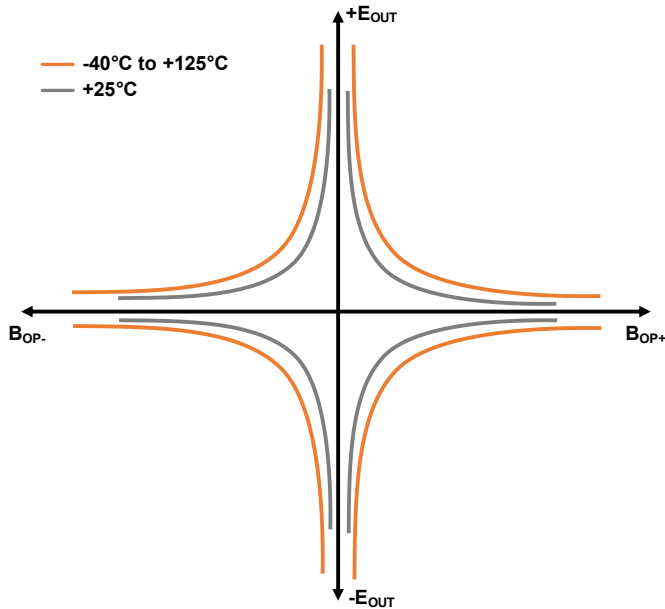

Figure 28. Total Output Error (E_{OUT}) vs. Field (B_{OP})

The CT450 achieves, after gain calibration, a total output error (E_{OUT}) that is less than $\pm 1.0\%$ of Full-Scale (FS) over supply voltage and temperature. It is designed with innovative and proprietary TMR sensors and circuit blocks to provide very accurate magnetic field measurements regardless of the operating conditions.

Power-On Time (t_{ON})

The Power-On Time (t_{ON}) of 100 μs is the amount of time required by CT450 to start up, fully power the chip and becoming fully operational from the moment the supply voltage is greater than the UVLO voltage. This time includes the ramp up time and the settling time (within 10% of steady-state voltage under an applied magnetic field) after the power supply have reached the minimum V_{CC} .

Response Time ($t_{RESPONSE}$)

The Response Time ($t_{RESPONSE}$) of 300 ns for the CT450 is the time interval between the following terms:

1. When the primary field/current signal reaches 90% of its final value,
2. When the chip reaches 90% of its output corresponding to the applied field/current.

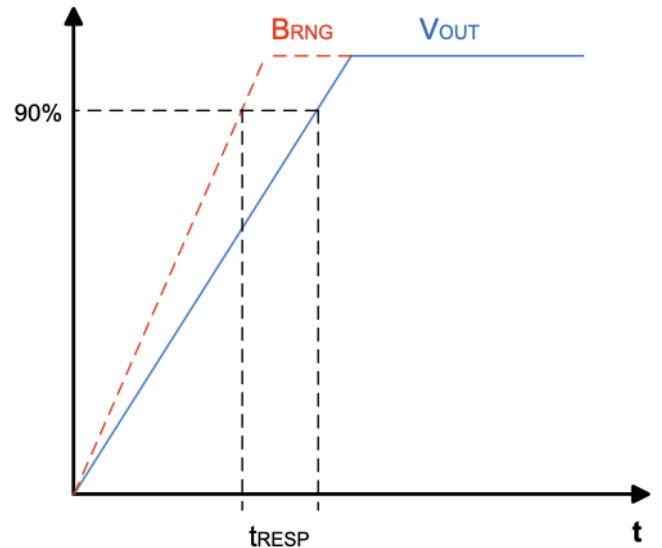

Figure 29. CT450 Response Time Curve

Rise Time (t_{RISE})

The CT450's rise time, t_{RISE} , is the time interval of when it reaches 10% and 90% of the full-scale output voltage. The t_{RISE} of the CT450 is 200 ns.

Propagation Delay (t_{DELAY})

The Propagation Delay (t_{DELAY}) is the time difference between these two events:

1. When the primary current reaches 20% of its final value
2. When the chip reaches 20% of its output corresponding to the applied field/current.

The CT450 has a propagation delay of 250 ns.

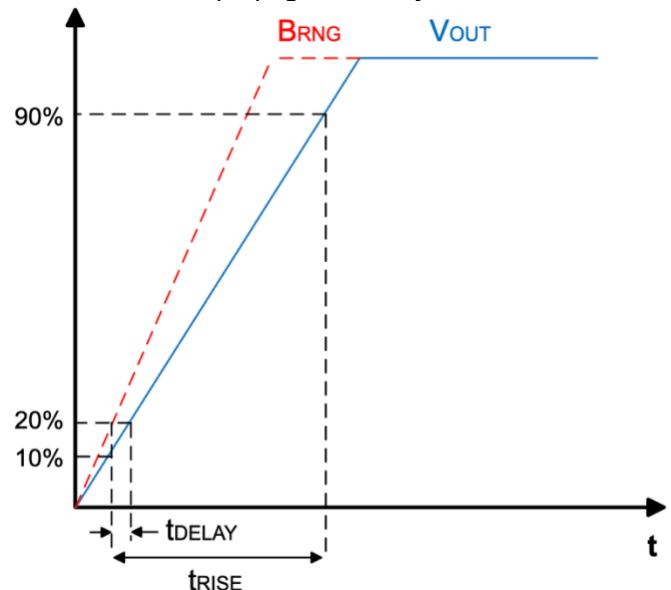

Figure 30. CT450 Propagation Delay and Rise Time Curve

Under-Voltage Lockout (UVLO)

The Under-Voltage Lock-out protection circuitry of the CT450 is activated when the supply voltage (V_{CC}) falls below 2.45 V. The CT450 remains in a low quiescent state until V_{CC} rises above the UVLO threshold (2.50 V). In this condition where the V_{CC} is less than 2.45 V and UVLO is triggered, the output from the CT450 is not valid. Once the V_{CC} rises above 4.0 V then the UVLO is cleared.

Current Sensing

The CT450 can sense and therefore measure the current by either placing a current-carrying busbar above or under the device. The busbar should be placed crosswise or over the pins of the package for the CT450 (in SOIC-8) to measure the current. The chip is also sensitive enough to measure the current from a PCB trace that is routed underneath it.

Bypass Capacitor

A single 1.0 μF capacitor is needed for the VCC pin to reduce the noise from the power supply and other circuits. This capacitor should be placed as close as possible to the CT450 to minimize inductance and resistance between the two devices.

VREF Resistors (TSSOP-8)

In designs where the VREF pin of the CT450 in TSSOP-8 is used, a 10 k Ω resistor must be connected as close to the pin as possible in series with a load. If the VREF pin is not needed in the application, then this pin should not be connected and be left floating.

Recommended PCB Layout

The CT450 is able to sense the field generated by the current flowing through a Printed Circuit Board (PCB) trace or busbar. Figure 31 shows the schematic for the CTD450 which is evaluation board for the CT450.

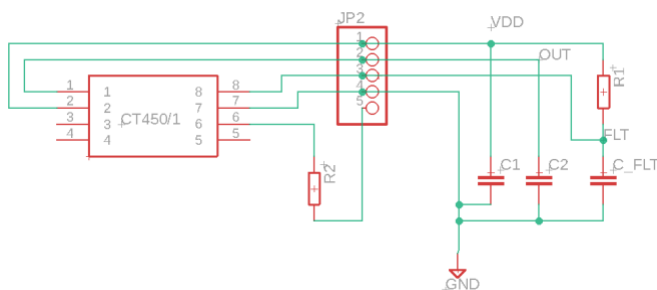

Figure 31. CTD450 Evaluation Board Schematic

The PCB layout of the CTD450 is shown in Figure 32 where the CT450 can sense the current through the PCB trace on the bottom layer of a 4-layer PCB. The width of the PCB trace and the thickness of the copper used will dictate the amount of current that it can carry. Please use Crocus' Contactless Current Sensor Calculator to set the parameters to determine the amount of current the PCB trace (or busbar) can support.

For the implementation of the current trace on the bottom layer, a distance of 1.60 mm between the IC pads on the top side of the PCB to the bottom layer of the trace will yield an isolation voltage that is greater than 5.0 kV.

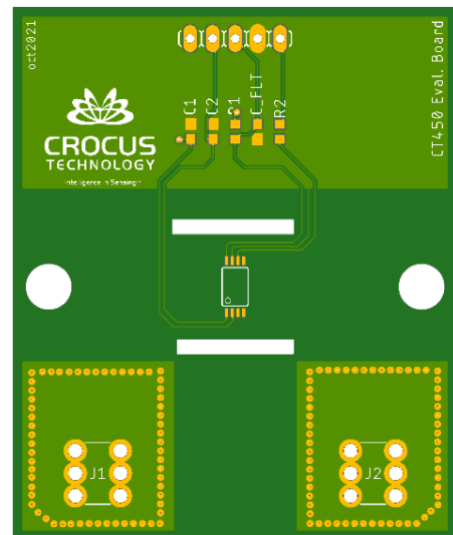

Figure 32. CTD450 Evaluation Board PCB Layout

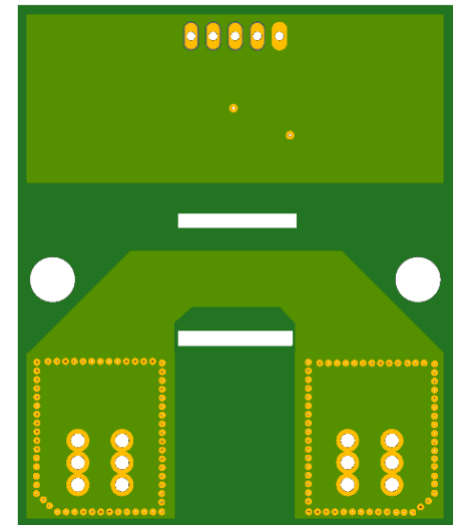

Figure 33. CTD450 Evaluation Board PCB Layout

XtremeSense® TMR Current Sensor Location

The XtremeSense TMR current sensor location of the CT450 is shown below. All dimensions in the figures are nominal.

SOIC-8 Package

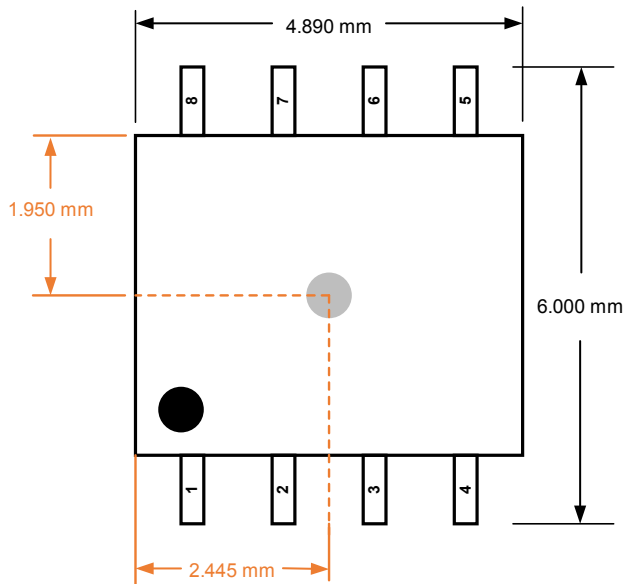

Figure 34. XtremeSense TMR Current Sensor Location in x-y Plane for CT450 in SOIC-8 Package

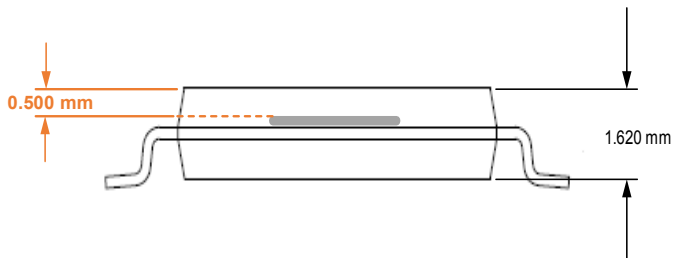

Figure 35. XtremeSense TMR Current Sensor Location in z Dimension for CT450 in SOIC-8 Package

TSSOP-8 Package

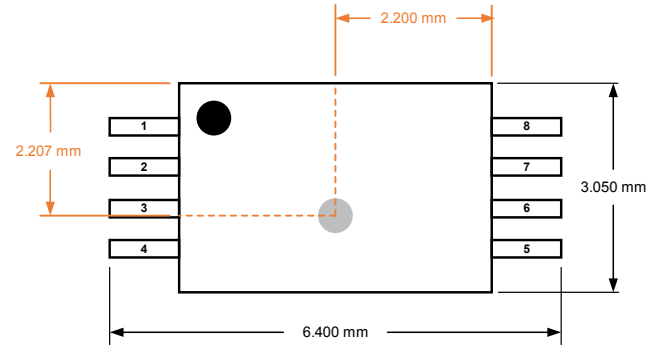

Figure 36. XtremeSense TMR Current Sensor Location in x-y Plane for CT450 in TSSOP-8 Package

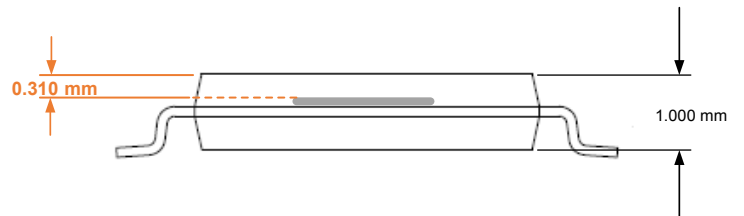

Figure 37. XtremeSense TMR Current Sensor Location in z Dimension for CT450 in TSSOP-8 Package

SOIC-8 Package Drawing and Dimensions

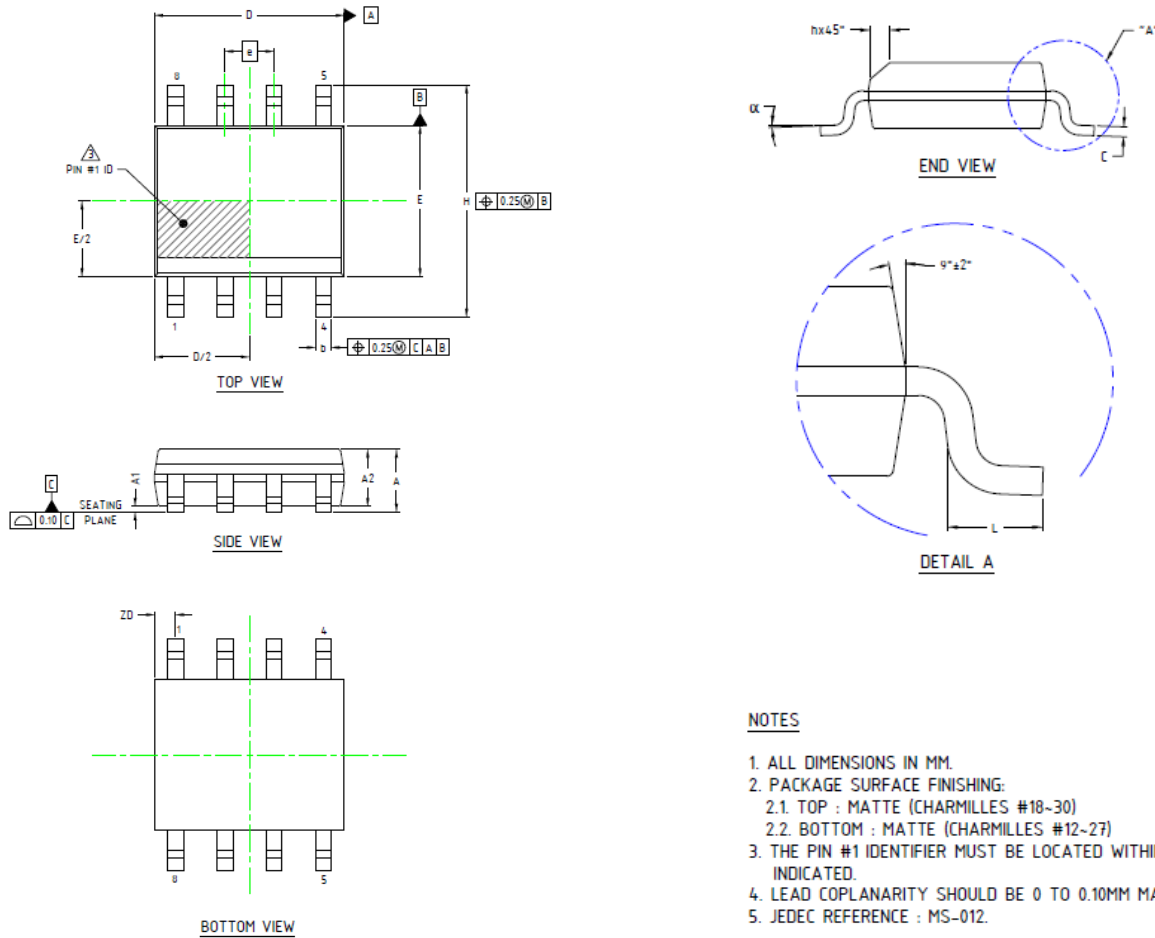

Figure 38. SOIC-8 Package Drawing

Table 3. CT450 SOIC-8 Package Dimensions

Symbol	Dimensions in Millimeters (mm)		
	Min.	Typ.	Max.
A1	0.10	0.18	0.25
b	0.36	0.41	0.46
C	0.19	0.22	0.25
D	4.80	4.89	4.98
E	3.81	3.90	3.99
e	1.27 BSC		
H	5.80	6.00	6.20
h	0.25	0.37	0.50
L	0.41	-	1.27
A	1.52	1.62	1.72
α	0°	-	8°
ZD	0.53 REF		
A2	1.37	1.47	1.57

Crocus Technology provides package drawings as a service to customers considering or planning to use Crocus products in their designs. Drawings may change without notice. Please note the revision and date of the data sheet and contact a Crocus Technology representative to verify or obtain the most recent version. The package specifications do not expand the terms of Crocus Technology's worldwide terms and conditions, specifically the warranty therein, which covers Crocus Technology's products.

SOIC-8 Tape & Pocket Drawing and Dimensions

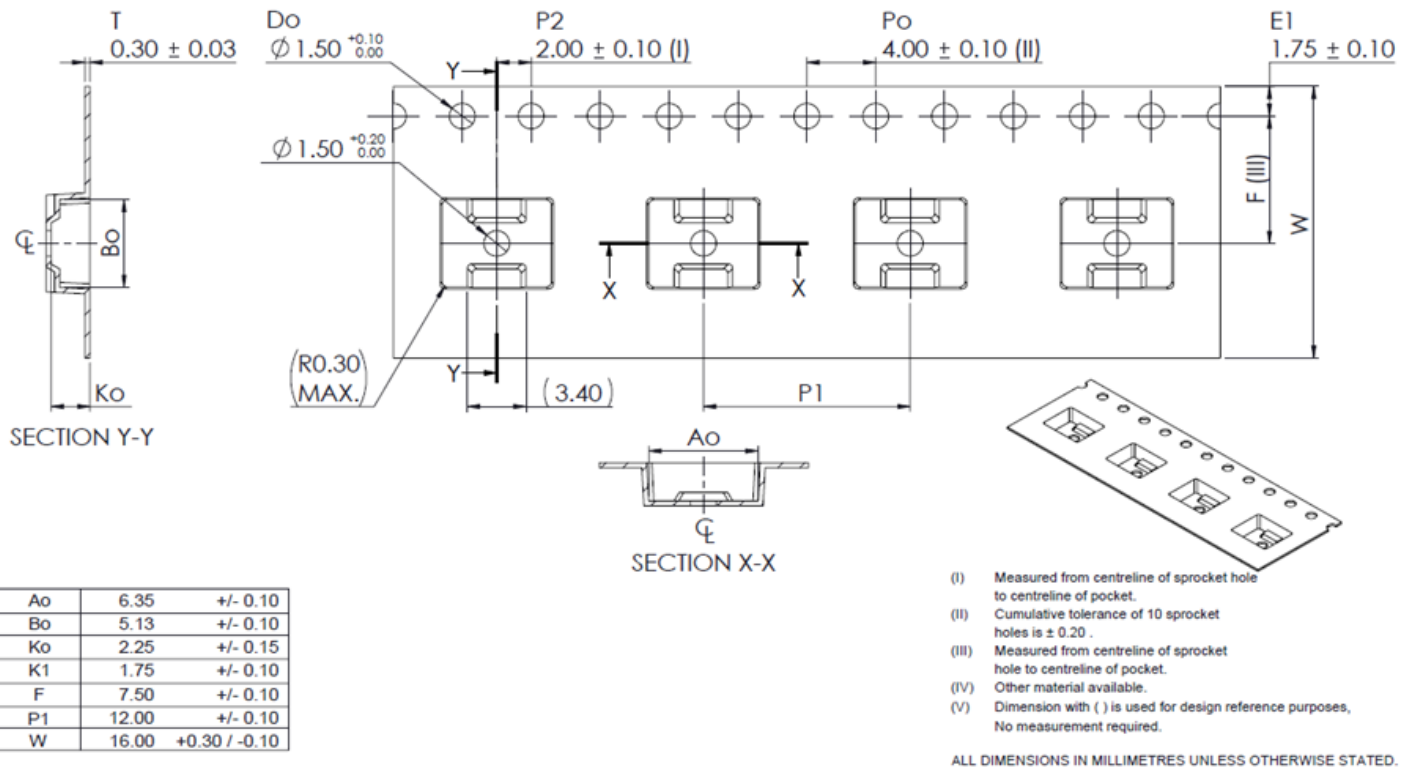

Figure 39. SOIC-8 Package Drawing

TSSOP-8 Package Drawing and Dimensions

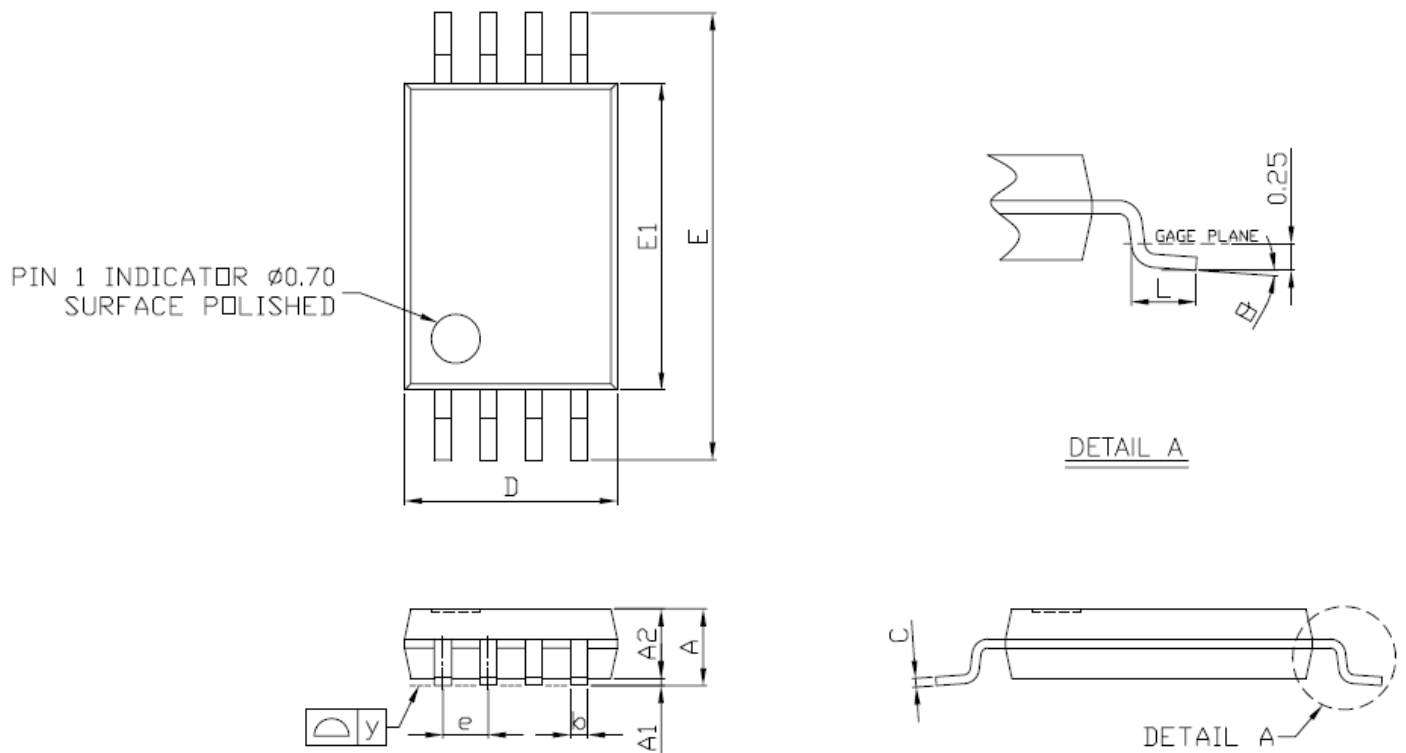

Figure 40. TSSOP-8 Package Drawing

Table 4. CT450 TSSOP-8 Package Dimensions

Symbol	Dimensions in Millimeters (mm)		
	Min.	Typ.	Max.
A	1.05	1.10	1.20
A1	0.05	0.10	0.15
A2	-	1.00	1.05
b	0.25	-	0.30
C	-	0.127	-
D	2.90	3.05	3.10
E	6.20	6.40	6.60
E1	4.30	4.40	4.50
e	-	0.65	-
L	0.50	0.60	0.70
y	-	-	0.076
θ	0°	4°	8°

Crocus Technology provides package drawings as a service to customers considering or planning to use Crocus products in their designs. Drawings may change without notice. Please note the revision and date of the data sheet and contact a Crocus Technology representative to verify or obtain the most recent version. The package specifications do not expand the terms of Crocus Technology's worldwide terms and conditions, specifically the warranty therein, which covers Crocus Technology's products.

TSSOP-8 Tape & Pocket Drawing and Dimensions

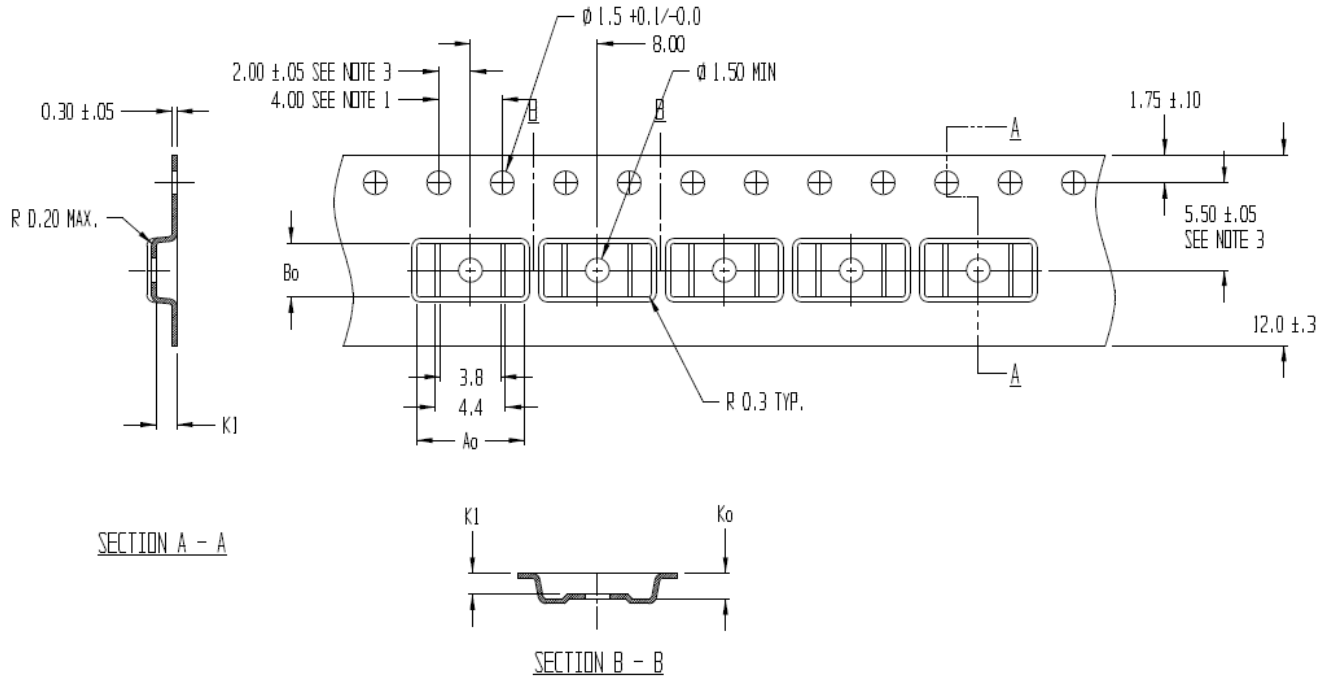

NOTES:

1. 10 SPROCKET HOLE PITCH CUMULATIVE TOLERANCE ± 0.2
2. CAMBER IN COMPLIANCE WITH EIA 481
3. POCKET POSITION RELATIVE TO SPROCKET HOLE MEASURED AS TRUE POSITION OF POCKET, NOT POCKET HOLE

$Ao = 6.80$
 $Bo = 3.40$
 $Ko = 1.60$
 $K1 = 1.30$

Figure 41. TSSOP-8 Tape and Pocket Drawings

Package Information

Table 5. CT450 Package Information

Part Number	Package Type	# of Leads	Quantity per Reel	Lead Finish	MSL Rating ⁽²⁾	Operating Temperature ⁽³⁾	Device Marking ⁽⁴⁾
CT450-H06DRSN08	SOIC	8	3,000	Sn	3	-40°C to +125°C	CT450 06DR YYWWLL
CT450-H06MRSN08	SOIC	8	3,000	Sn	3	-40°C to +125°C	CT450 06MR YYWWLL
CT450-H12DRSN08	SOIC	8	3,000	Sn	3	-40°C to +125°C	CT450 12DR YYWWLL
CT450-H12MRSN08	SOIC	8	3,000	Sn	3	-40°C to +125°C	CT450 12MR YYWWLL
CT450-H24DRSN08	SOIC	8	3,000	Sn	3	-40°C to +125°C	CT450 24DR YYWWLL
CT450-H24MRSN08	SOIC	8	3,000	Sn	3	-40°C to +125°C	CT450 24MR YYWWLL
CT450-H00DRSN08	SOIC	8	3,000	Sn	3	-40°C to +125°C	CT450 00DR YYWWLL
CT450-H00MRSN08	SOIC	8	3,000	Sn	3	-40°C to +125°C	CT450 00MR YYWWLL
CT450-H00DRTS08	TSSOP	8	3,000	Sn	3	-40°C to +125°C	CT450 00DR YYWWLL
CT450-H00MRTS08	TSSOP	8	3,000	Sn	3	-40°C to +125°C	CT450 00MR YYWWLL
CT450-A00DRSN08	SOIC	8	3,000	Sn	3	-40°C to +125°C	CT450 A00DR YYWWLL
CT450-A00MRSN08	SOIC	8	3,000	Sn	3	-40°C to +125°C	CT450 A00MR YYWWLL
CT450-A00DRTS08	TSSOP	8	3,000	Sn	3	-40°C to +125°C	CT450 A00DR YYWWLL
CT450-A00MRTS08	TSSOP	8	3,000	Sn	3	-40°C to +125°C	CT450 A00MR YYWWLL

(1) RoHS is defined as semiconductor products that are compliant to the current EU RoHS requirements. It also will meet the requirement that RoHS substances do not exceed 0.1% by weight in homogeneous materials. Green is defined as the content of Chlorine (Cl), Bromine (Br) and Antimony Trioxide based flame retardants satisfy JS709B low halogen requirements of $\leq 1,000$ ppm.

(2) MSL Rating = Moisture Sensitivity Level Rating as defined by JEDEC standard classifications.

(3) Package will withstand ambient temperature range of -40°C to +125°C and storage temperature range of -65°C to +150°C.

(4) Device Marking for CT450 in SOIC-8 is defined as CT450 xxZR YYWWLL where the first 2 lines = part number, and third line is YY = year, WW = work week and LL = lot code. In TSSOP-8 is defined as CT450 xxZR YYWWLL where the first line = part number, and second line is YY = year, WW = work week and LL = lot code.

Device Marking

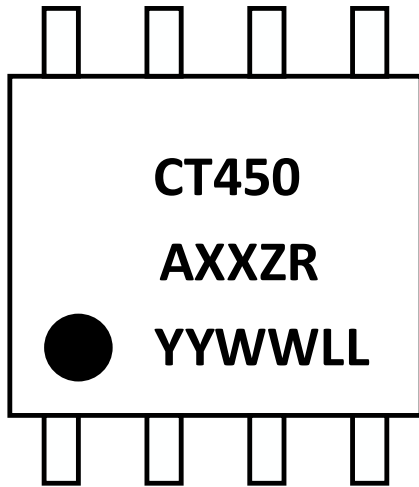

Figure 42. CT450 Device Marking for 8-lead SOIC Package

Row No.	Code	Definition
3	•	Pin 1 Indicator
1	CT450	Crocus Part Number
2	A	Automotive Identifier
2	XX	Maximum Field Rating
2	ZR	Polarity
3	YY	Calendar Year
3	WW	Work Week
3	LL	Lot Code

Table 6. CT450 Device Marking Definition for 8-lead SOIC Package

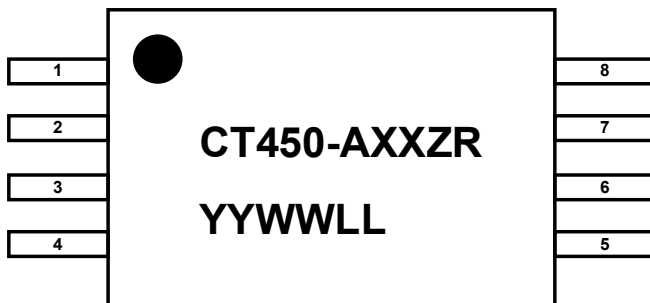

Figure 43. CT450 Device Marking for 8-lead TSSOP Package

Row No.	Code	Definition
1	•	Pin 1 Indicator
2	CT450	Crocus Part Number
2	A	Automotive Identifier
2	XX	Maximum Magnetic Field Rating
2	ZR	Polarity
3	YY	Calendar Year
3	WW	Work Week
3	LL	Lot Code

Table 7. CT450 Device Marking Definition for 8-lead TSSOP Package