



# CT452

## XtremeSense® TMR Coreless, Differential and Contactless Current Sensor with Programmable Gain

### FEATURES

- User Programmable Field Range:
  - 6 mT to 24mT
- Pre-set Magnetic Field Ranges:
  - 0 mT to +6 mT
  - -6 mT to +6 mT
- Linear Analog Output Voltage
- Common Mode Field Rejection: -50 dB
- 1 MHz Bandwidth
- Response Time < 300 ns
- Reference Voltage Output for Unipolar/Bipolar Field Measurements
- Supply Voltage: 4.75 V to 5.50 V
- Low Noise Performance
- Filter Pin to Reduce Noise on Output
- AEC-Q100 Grade 1
- Package Options:
  - 8-lead SOIC
  - 8-lead TSSOP

### APPLICATIONS

- Solar/Power Inverters
- Battery Management Systems
- Industrial Equipment
- PFC Systems
- Power Utility Meters
- Power Conditioner
- DC/DC Converters/Power Supplies

### PRODUCT DESCRIPTION

The CT452 is a high bandwidth and low noise integrated zero-loss contactless current sensor that uses Crocus Technology's patented XtremeSense TMR technology to enable high accuracy current measurements for many consumer, enterprise, and industrial applications. It supports six (6) field ranges where the CT452 senses and translates the magnetic field into a linear analog output voltage. It achieves a total error output of less than  $\pm 1.0\%$  over voltage and temperature.

This coreless current sensor is not only small in size and simple to design, but it also provides effective common mode rejection of more than -50 dB. This enables the CT452 to have greater than 90% immunity to stray magnetic fields thus having almost no impact on the accuracy of the current measurement.

It has less than 300 ns output response time while the current consumption is about 6.0 mA. The CT452 is equipped with a filter function to reduce the noise on the output pin.

The CT452 is assembled in an industry standard 8-lead SOIC package and a very low profile, 8-lead TSSOP package that are both "green" and RoHS compliant.

### PACKAGE: 8-lead SOIC and 8-lead TSSOP



*(Not to Scale)*

## Part Ordering Information

Part Number	Auto Grade	Range	Operating Temperature Range	Package	Packing Method
<b>Bipolar Sensitivity</b>					
CT452-H06MRTS08	-	±6 mT	-40°C to +125°C	8-lead TSSOP 3.00 x 6.40 x 1.10 mm	Tape & Reel
CT452-H06MRSN08	-	±6 mT	-40°C to +125°C	8-lead SOIC 4.89 x 6.00 x 1.62 mm	Tape & Reel
<b>Unipolar Sensitivity</b>					
CT452-H06DRTS08	-	6 mT	-40°C to +125°C	8-lead TSSOP 3.00 x 6.40 x 1.10 mm	Tape & Reel
CT452-H06DRSN08	-	6 mT	-40°C to +125°C	8-lead SOIC 4.89 x 6.00 x 1.62 mm	Tape & Reel
<b>Programmable Sensitivity</b>					
CT452-H00MRSN08	-	±6mT to ±24mT	-40°C to +125°C	8-lead SOIC 4.89 x 6.00 x 1.62 mm	Tape & Reel
CT452-H00DRSN08		6mT to 24mT		8-lead TSSOP 3.00 x 6.40 x 1.10 mm	
CT452-H00MRTS08		±6mT to ±24mT			
CT452-H00DRTS08		6mT to 24mT			
<b>Programmable Sensitivity – AEC-Q100</b>					
CT452-A00MRSN08	Grade 1	±6mT to ±24mT	-40°C to +125°C	8-lead SOIC 4.89 x 6.00 x 1.62 mm	Tape & Reel
CT452-A00DRSN08		6mT to 24mT		8-lead TSSOP 3.00 x 6.40 x 1.10 mm	
CT452-A00MRTS08		±6mT to ±24mT			
CT452-A00DRTS08		6mT to 24mT			

## Evaluation Board Ordering Information

Part Number	Magnetic Field Range	Operating Temperature Range	Package	Current Carrying Conductor
CTD452-BB-06U	0 mT to +6 mT	-40°C to +125°C	8-lead SOIC 4.89 x 6.00 x 1.62 mm	Bus Bar
CTD452-BB-06B	-6 mT to +6 mT			
CTD452-PT-06U	0 mT to +6 mT			PCB Trace
CTD452-PT-06B	-6 mT to +6 mT			

## Block Diagram

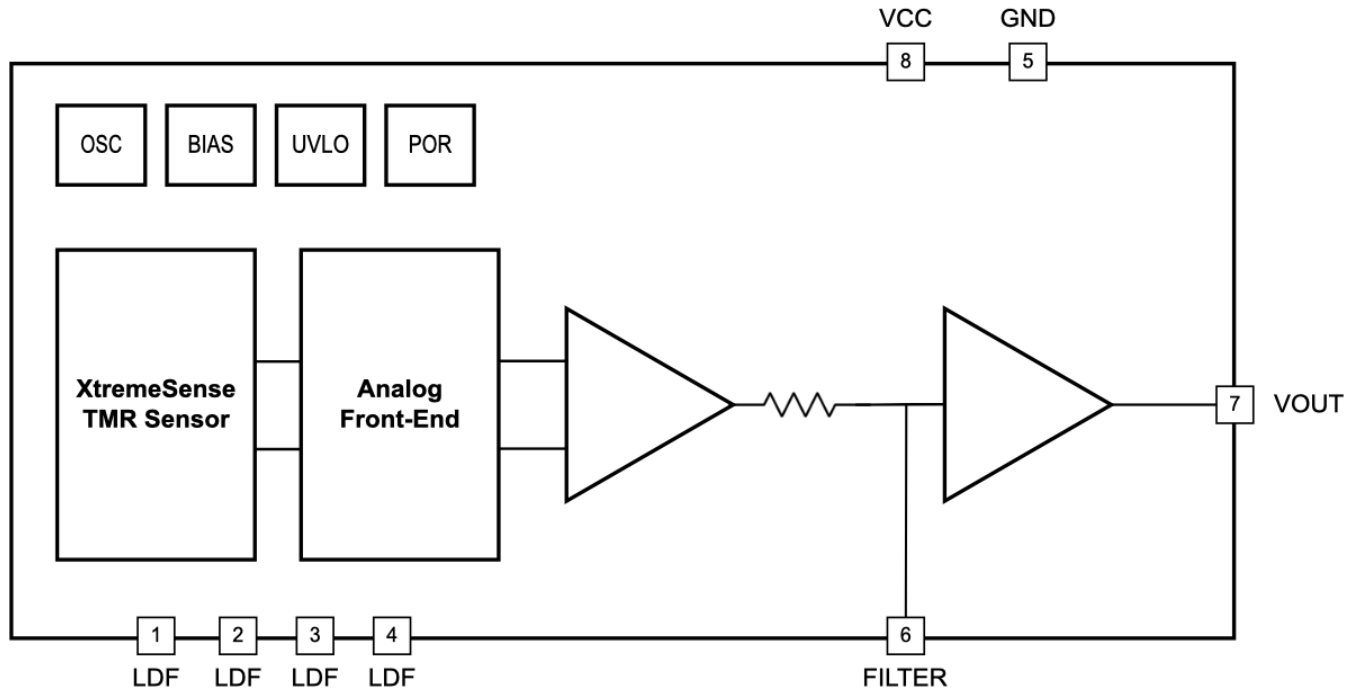

Figure 1. CT452 Functional Block Diagram for SOIC-8

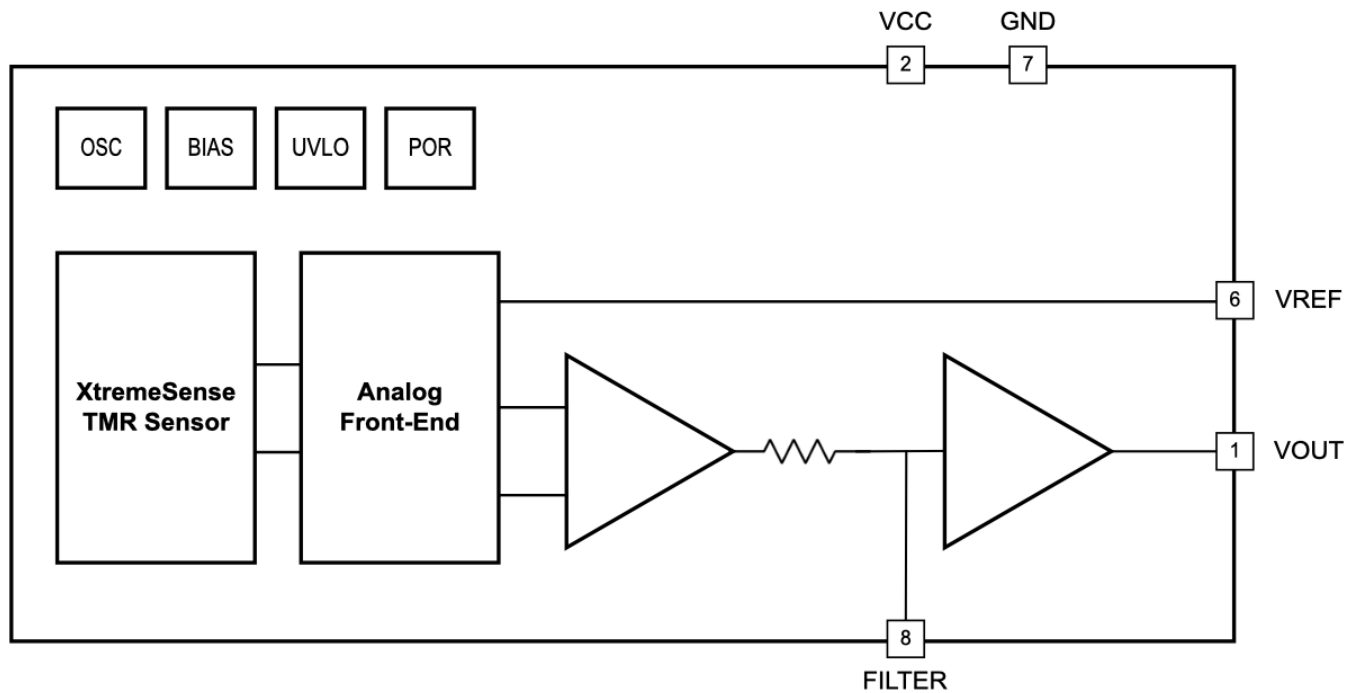

Figure 2. CT452 Functional Block Diagram for TSSOP-8

## CT452 Application Diagram

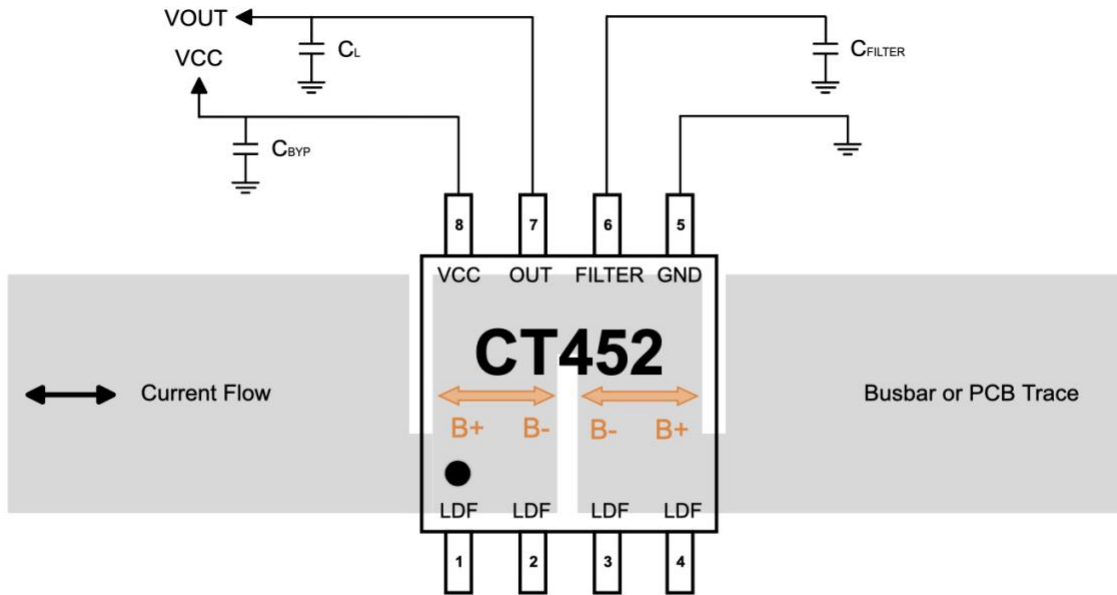

Figure 3. CT452 Application Diagram for SOIC-8

Table 1. Recommended External Components

Component	Description	Vendor & Part Number	Min.	Typ.	Max.	Unit
C <sub>BYP</sub>	1.0 $\mu$ F, X5R or Better	Murata GRM155C81A105KA12		1.0		$\mu$ F
C <sub>FILTER</sub>	Various, X5R or Better	Murata		Figure 16		pF

## CT452 Application Diagram

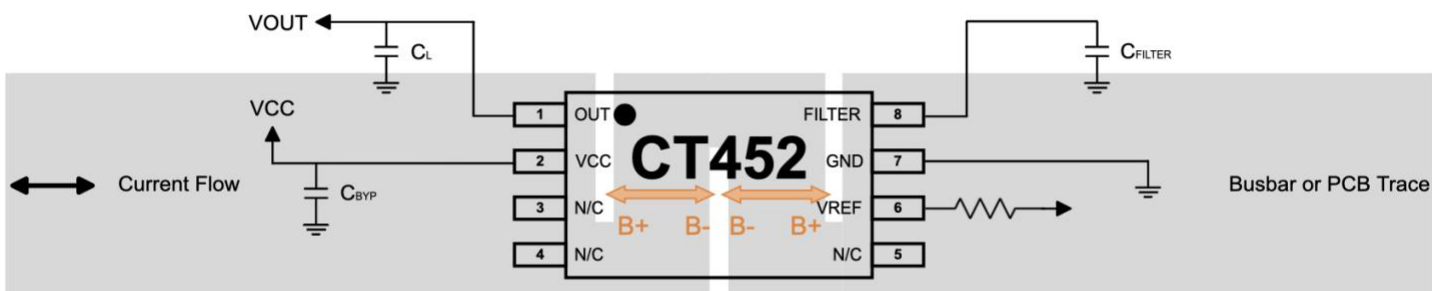

Figure 4. CT452 Application Diagram for TSSOP-8

Table 2. Recommended External Components

Component	Description	Vendor & Part Number	Min.	Typ.	Max.	Unit
C <sub>BYP</sub>	1.0 $\mu$ F, X5R or Better	Murata GRM155C81A105KA12		1.0		$\mu$ F
C <sub>FILTER</sub>	Various, X5R or Better	Murata		Figure 16		pF
R <sub>VREF</sub>	10 k $\Omega$ Resistor	Various		10		k $\Omega$

## CT452 SOIC-8 Pin Configuration

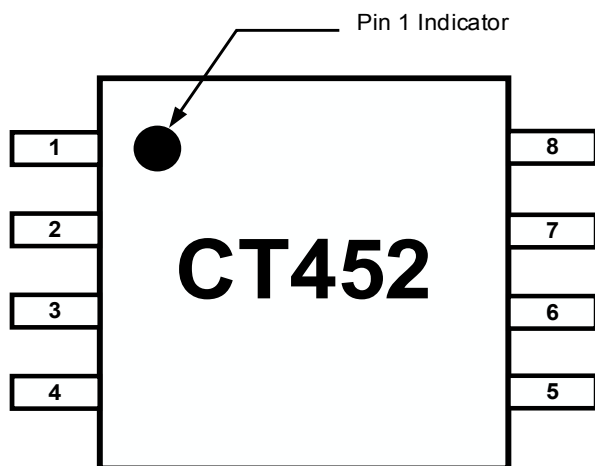

Figure 5. CT452 Pin-out Diagram for 8-lead SOIC Package (Top-Down View)

### Pin Definition

Pin #	Pin Name	Pin Description
1	LDF	Lead frame Pin – A single (1) LDF pin should be connected to GND. The other three (3) LDF pins should be left unconnected to avoid ground loops through the lead frame.
2		
3		
4		
5	GND	Ground.
6	FILTER	Filter pin to improve noise performance by connecting an external capacitor to set the cut-off frequency. No connect if the FILTER pin is not used.
7	OUT	Analog output voltage that represents the measured current/field.
8	VCC	Supply voltage.

## CT452 TSSOP-8 Pin Configuration

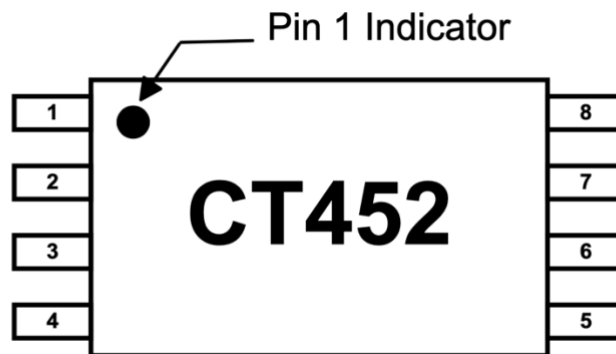

Figure 6. CT452 Pin-out Diagram for 8-lead TSSOP Package (Top-Down View)

### Pin Definition

Pin #	Pin Name	Pin Description
1	OUT	Analog output voltage that represents the measured current/field.
2	VCC	Supply voltage.
3	N/C	No connect (Do Not Use).
4		
5		
6	VREF	Reference voltage output. If not used, then do not connect.
7	GND	Ground.
8	FILTER	Filter pin to improve noise performance by connecting an external capacitor to set the cut-off frequency. No connect if the FILTER pin is not used.

## Absolute Maximum Ratings

Stresses exceeding the absolute maximum ratings may damage the CT452 and may not function or be operable above the recommended operating conditions and stressing the parts to these levels is not recommended. In addition, extended exposure to stresses above the recommended operating conditions may affect device reliability. The absolute maximum ratings are stress ratings only.

Symbol	Parameter	Min.	Max.	Unit
$V_{CC}$	Supply Voltage	-0.3	6.0	V
$V_{IO}$	Analog Input/Output Pins Maximum Voltage	-0.3	$V_{CC} + 0.3^*$	V
ESD	Electrostatic Discharge Protection Level	Human Body Model (HBM) per JESD22-A114	$\pm 2.0$	kV
		Charged Device Model (CDM) per JESD22-C101	$\pm 0.5$	
$T_J$	Junction Temperature	-40	+150	°C
$T_{STG}$	Storage Temperature	-65	+155	°C
$T_L$	Lead Soldering Temperature, 10 Seconds		+260	°C

\*The lower of  $V_{CC} + 0.3$  V or 6.0 V.

## Recommended Operating Conditions

The Recommended Operating Conditions table defines the conditions for actual operation of the CT452. Recommended operating conditions are specified to ensure optimal performance to the specifications. Crocus Technology does not recommend exceeding them or designing to absolute maximum ratings.

Symbol	Parameter	Min.	Typ.	Max.	Unit
$V_{CC}$	Supply Voltage Range	4.75	5.00	5.50	V
$V_{OUT}$	OUT Voltage Range	0		$V_{CC}$	V
$I_{OUT}$	OUT Current			$\pm 1.0$	mA
$T_A$	Operating Ambient Temperature	-40	+25	+125	°C



## Electrical Specifications

### General Parameters

Unless otherwise specified:  $V_{CC} = 4.75\text{ V to }5.50\text{ V}$ ,  $T_A = -40^\circ\text{C to }+125^\circ\text{C}$ ,  $C_{BYP} = 1.0\ \mu\text{F}$ . Typical values are  $V_{CC} = 5.00\text{ V}$  and  $T_A = +25^\circ\text{C}$ .

Symbol	Parameter	Conditions	Min.	Typ.	Max.	Unit
<b>Power Supplies</b>						
$I_{CC}$	Supply Current	$f_{BW} = 1\text{ MHz}$ No load, $B_{OP} = 0\text{ mT}$		6.0	9.0	mA
$I_{OUT}$	OUT Maximum Drive Capability	OUT covers 10% to 90% of $V_{CC}$ span.	-1.0		+1.0	mA
$C_{L\_OUT}$	OUT Capacitive Load				100	pF
$R_{L\_OUT}$	OUT Resistive Load			100		k $\Omega$
$R_{FILTER}$	Internal Filter Resistance <sup>(1)</sup>			15		k $\Omega$
PSRR	Power Supply Rejection Ratio <sup>(1)</sup>			35		dB
SPSRR	Sensitivity Power Supply (PS) Rejection Ratio <sup>(1)</sup>			35		dB
OPSRR	Offset PS Rejection Ratio <sup>(1)</sup>			40		dB
CMFRR	Common Mode Field Rejection Ratio <sup>(1)</sup>			-50		dB
<b>Analog Output (OUT)</b>						
$V_{OUT}$	OUT Voltage Linear Range, Typical	$V_{SIG\_AC} = \pm 2.00\text{ V}$ $V_{SIG\_DC} = +4.00\text{ V}$	0.50		4.50	V
$V_{OUT\_SAT}$	Output High Saturation Voltage	$T_A = +25^\circ\text{C}$	$V_{CC} - 0.30$	$V_{CC} - 0.25$		V
<b>Reference Voltage (VREF) for TSSOP-8 Only</b>						
$V_{REF}$	Reference Voltage	Unipolar Version		0.50		V
		Bipolar Version		2.50		
$I_{VREF}$	VREF Maximum Drive Capability		-50		+50	$\mu\text{A}$
$C_{L\_VREF}$	VREF Capacitive Load				10	pF
$R_{L\_VREF}$	VREF Resistive Load			10		k $\Omega$
<b>Timings</b>						
$t_{ON}$	Power-On Time	$V_{CC} \geq 4.0\text{ V}$		100	200	$\mu\text{s}$
$t_{RISE}$	Rise Time <sup>(1)</sup>	$B_{OP} = B_{OP(MAX)}$ , $T_A = +25^\circ\text{C}$ , $C_L = 100\text{ pF}$		200		ns
$t_{RESPONSE}$	Response Time <sup>(1)</sup>			300		ns
$t_{DELAY}$	Propagation Delay <sup>(1)</sup>			250		ns
<b>Protection</b>						
$V_{UVLO}$	Under-Voltage Lockout	Rising $V_{CC}$		2.50		V
		Falling $V_{CC}$		2.45		V
$V_{UV\_HYS}$	UVLO Hysteresis			50		mV

(1) Guaranteed by design and characterization; not tested in production.

## Electrical Characteristics

$V_{CC} = 5.00\text{ V}$  and  $T_A = +25^\circ\text{C}$  and  $C_{BYP} = 1.0\ \mu\text{F}$  (unless otherwise specified)

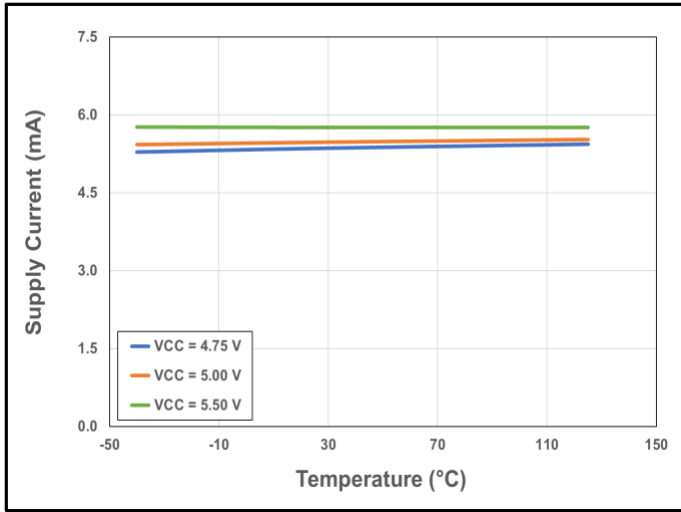

Figure 7. CT452 Supply Current vs. Temperature vs. Supply Voltage

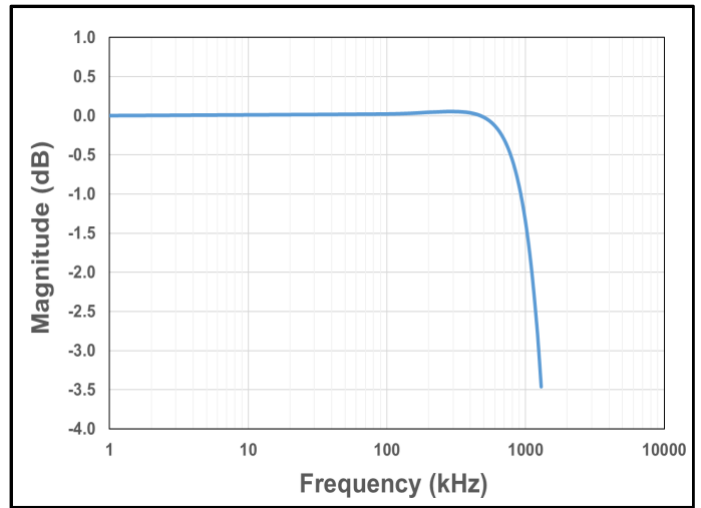

Figure 8. CT452 Bandwidth with  $C_{FILTER} = 1.0\ \text{pF}$

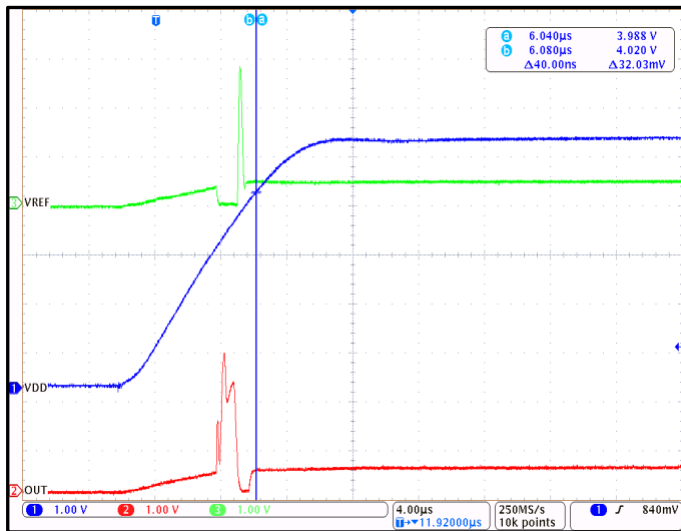

Figure 9. CT452 Startup Waveforms for  $V_{OQ} = 0.50\text{ V}$  (Unipolar Sensor Version)

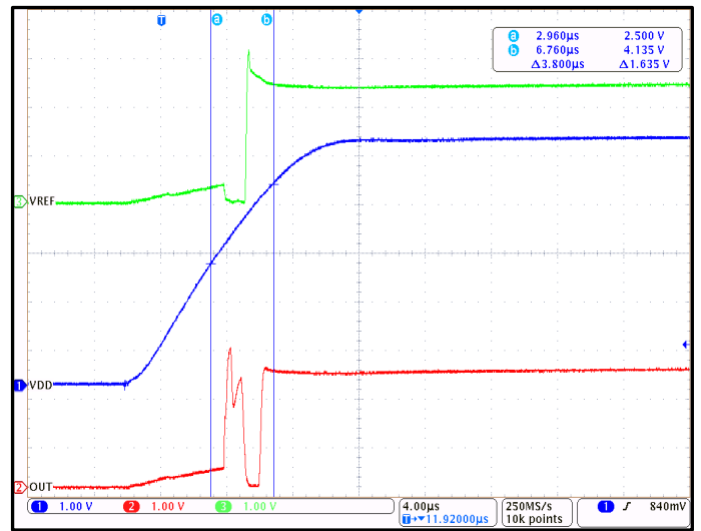

Figure 10. CT452 Startup Waveforms for  $V_{OQ} = 2.50\text{ V}$  (Bipolar Sensor Version)

## CT452-x06DR: 0 mT to +6 mT

Unless otherwise specified:  $V_{CC} = 4.75\text{ V to }5.50\text{ V}$ ,  $T_A = -40^\circ\text{C to }+125^\circ\text{C}$ ,  $C_{BYP} = 1.0\ \mu\text{F}$ . Typical values are  $V_{CC} = 5.00\text{ V}$  and  $T_A = +25^\circ\text{C}$ .

Symbol	Parameter	Conditions	Min.	Typ.	Max.	Unit
$B_{RNG}$	Magnetic Field Range		0		+6	mT
$V_{OQ}$	Voltage Output Quiescent	$T_A = +25^\circ\text{C}$ , $B_{OP} = 0\text{ mT}$	0.495	0.500	0.505	V
S	Sensitivity	$B_{RNG(MIN)} < B_{OP} < B_{RNG(MAX)}$		666.7		mV/mT
$f_{BW}$	Bandwidth <sup>(1)</sup>	Small Signal = -3 dB		1.0		MHz
$e_N$	Noise <sup>(1)</sup>	$T_A = +25^\circ\text{C}$ , $f_{BW} = 100\text{ kHz}$		1.63		mV <sub>RMS</sub>
				2.45		$\mu\text{T}_{RMS}$
<b>OUT Accuracy Performance</b>						
$E_{LIN}$	Non-Linearity Error <sup>(1)</sup>			$\pm 0.2$		% FS
$E_{SENS}$	Sensitivity Error <sup>(1)</sup>			$\pm 0.3$		% FS
$V_{OFFSET}$	Offset Voltage <sup>(1)</sup>	$B_{OP} = 0\text{ mT}$		$\pm 10.0$		mV
				$\pm 0.3$		% FS
<b>Lifetime Drift</b>						
$E_{TOT\_DRIFT}$	Total Output Error Lifetime Drift <sup>(1)</sup>			$\pm 1.0$		% FS

(1) Guaranteed by design and characterization; not tested in production.

## Electrical Characteristics for CT452-x06DR

$V_{CC} = 5.0\text{ V}$  and  $T_A = +25^\circ\text{C}$  and  $C_{BYP} = 1.0\ \mu\text{F}$  (unless otherwise specified)

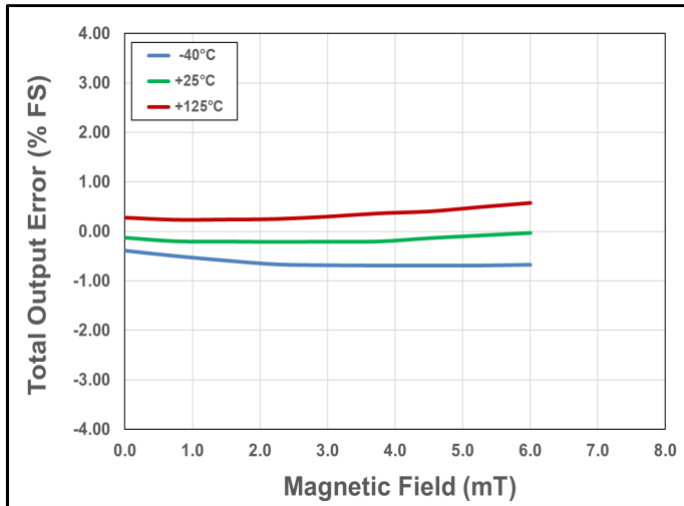

Figure 11. Total Output Error vs. B Field vs. Temperature

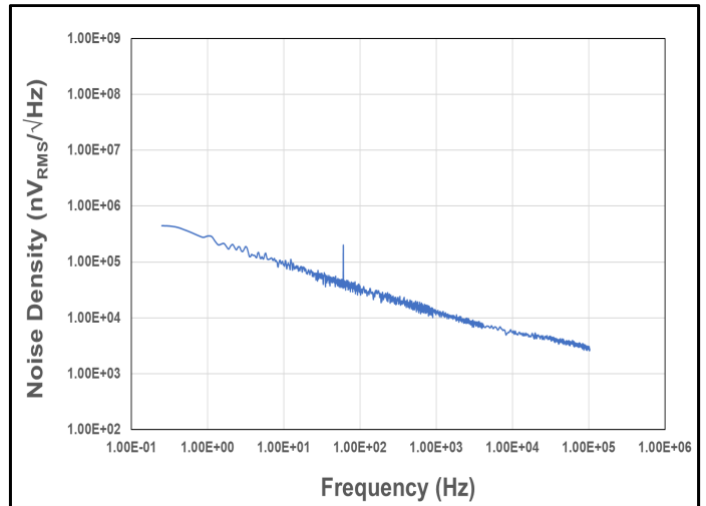

Figure 12. Noise Density vs. Frequency

## CT452-x06MR: -6 mT to +6 mT

Unless otherwise specified:  $V_{CC} = 4.75\text{ V to }5.50\text{ V}$ ,  $T_A = -40^\circ\text{C to }+125^\circ\text{C}$ ,  $C_{BYP} = 1.0\ \mu\text{F}$ . Typical values are  $V_{CC} = 5.00\text{ V}$  and  $T_A = +25^\circ\text{C}$ .

Symbol	Parameter	Conditions	Min.	Typ.	Max.	Unit
B <sub>RNG</sub>	Magnetic Field Range		-6		+6	mT
V <sub>OQ</sub>	Voltage Output Quiescent	T <sub>A</sub> = +25°C, B <sub>OP</sub> = 0 mT	2.490	2.500	2.510	V
S	Sensitivity	B <sub>RNG(MIN)</sub> < B <sub>OP</sub> < B <sub>RNG(MAX)</sub>		333.3		mV/mT
f <sub>BW</sub>	Bandwidth <sup>(1)</sup>	Small Signal = -3 dB		1.0		MHz
e <sub>N</sub>	Noise <sup>(1)</sup>	T <sub>A</sub> = +25°C, f <sub>BW</sub> = 100 kHz		0.92		mV <sub>RMS</sub>
				2.77		μT <sub>RMS</sub>
<b>OUT Accuracy Performance</b>						
E <sub>LIN</sub>	Non-Linearity Error <sup>(1)</sup>			±0.1		% FS
E <sub>SENS</sub>	Sensitivity Error <sup>(1)</sup>			±0.3		% FS
V <sub>OFFSET</sub>	Offset Voltage <sup>(1)</sup>	B <sub>OP</sub> = 0 mT		±8.0		mV
				±0.2		% FS
<b>Lifetime Drift</b>						
E <sub>TOT_DRIFT</sub>	Total Output Error Lifetime Drift <sup>(1)</sup>			±1.0		% FS

(1) Guaranteed by design and characterization; not tested in production.

## Electrical Characteristics for CT452-x06MR

$V_{CC} = 5.0\text{ V}$  and  $T_A = +25^\circ\text{C}$  and  $C_{BYP} = 1.0\ \mu\text{F}$  (unless otherwise specified)

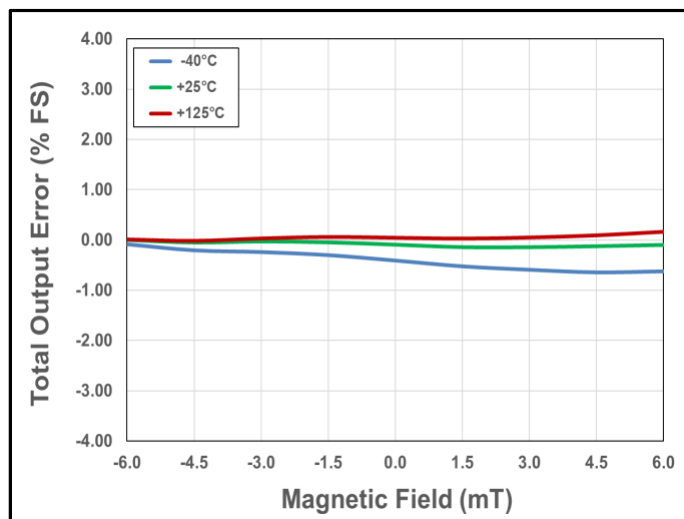

Figure 13. Total Output Error vs. B Field vs. Temperature

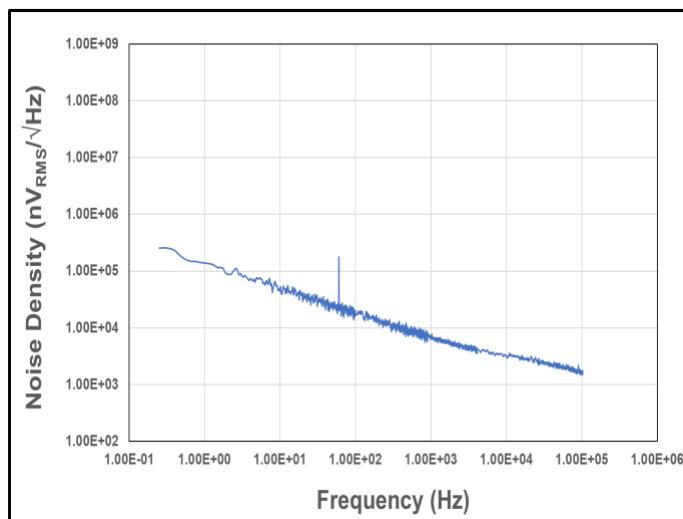

Figure 14. Noise Density vs. Frequency

**CT452-x00MR: Programmable Gain**

Unless otherwise specified:  $V_{CC} = 4.75\text{ V to }5.50\text{ V}$ ,  $T_A = -40^\circ\text{C to }+125^\circ\text{C}$ ,  $C_{BYP} = 1.0\ \mu\text{F}$ . Typical values are  $V_{CC} = 5.00\text{ V}$  and  $T_A = +25^\circ\text{C}$ .

Symbol	Parameter	Conditions	Min.	Typ.	Max.	Unit
$B_{PRNG}$	Programmable Magnetic Field Range		$\pm 6$		$\pm 24$	mT
$V_{OQ}$	Voltage Output Quiescent	$T_A = +25^\circ\text{C}$ , $B_{OP} = 0\text{ mT}$	2.490	2.500	2.510	V
S	Sensitivity	$B_{RNG(MIN)} < B_{OP} < B_{RNG(MAX)}$	83.4		333.3	mV/mT
$f_{BW}$	Bandwidth <sup>(1)</sup>	Small Signal = -3 dB		1.0		MHz
$e_N$	Noise <sup>(1)</sup>	$T_A = +25^\circ\text{C}$ , $f_{BW} = 100\text{ kHz}$	0.38	-	0.92	mV <sub>RMS</sub>
			2.77	-	4.56	$\mu\text{T}_{RMS}$
<b>OUT Accuracy Performance</b>						
$E_{LIN}$	Non-Linearity Error <sup>(1)</sup>			$\pm 0.2$		% FS
$E_{SENS}$	Sensitivity Error <sup>(1)</sup>			$\pm 0.3$		% FS
$V_{OFFSET}$	Offset Voltage <sup>(1)</sup>	$B_{OP} = 0\text{ mT}$	$\pm 7.0$	-	$\pm 8.0$	mV
			$\pm 0.2$	-	$\pm 0.2$	% FS
<b>Lifetime Drift</b>						
$E_{TOT\_DRIFT}$	Total Output Error Lifetime Drift <sup>(1)</sup>			$\pm 1.0$		% FS

(1) Guaranteed by design and characterization; not tested in production.

**Calibration Description**

CT452-x00MR is factory trimmed for sensitivity and offset temperature drift. The sensor provides the ability to adjust gain to allow for all the mechanical tolerances during manufacturing. Gain calibration is recommended to be performed at room-temperature ( $25^\circ\text{C}$ ) using Crocus Technology's CTC4000 Calibration Box.

**CT452-x00DR: Programmable Gain**

Unless otherwise specified:  $V_{CC} = 4.75\text{ V to }5.50\text{ V}$ ,  $T_A = -40^\circ\text{C to }+125^\circ\text{C}$ ,  $C_{BYP} = 1.0\ \mu\text{F}$ . Typical values are  $V_{CC} = 5.00\text{ V}$  and  $T_A = +25^\circ\text{C}$ .

Symbol	Parameter	Conditions	Min.	Typ.	Max.	Unit
$B_{PRNG}$	Programmable Magnetic Field Range		6		24	mT
$V_{OQ}$	Voltage Output Quiescent	$T_A = +25^\circ\text{C}$ , $B_{OP} = 0\text{ mT}$	0.495	0.500	0.505	V
S	Sensitivity	$B_{RNG(MIN)} < B_{OP} < B_{RNG(MAX)}$	166.7		666.7	mV/mT
$f_{BW}$	Bandwidth <sup>(1)</sup>	Small Signal = -3 dB		1.0		MHz
$e_N$	Noise <sup>(1)</sup>	$T_A = +25^\circ\text{C}$ , $f_{BW} = 100\text{ kHz}$	0.46	-	1.63	mV <sub>RMS</sub>
			2.45	-	2.77	$\mu\text{T}_{RMS}$
<b>OUT Accuracy Performance</b>						
$E_{LIN}$	Non-Linearity Error <sup>(1)</sup>			$\pm 0.3$		% FS
$E_{SENS}$	Sensitivity Error <sup>(1)</sup>			$\pm 0.3$		% FS
$V_{OFFSET}$	Offset Voltage <sup>(1)</sup>	$B_{OP} = 0\text{ mT}$	$\pm 8.0$	-	$\pm 10.0$	mV
			$\pm 0.2$	-	$\pm 0.3$	% FS
<b>Lifetime Drift</b>						
$E_{TOT\_DRIFT}$	Total Output Error Lifetime Drift <sup>(1)</sup>			$\pm 1.0$		% FS

(2) Guaranteed by design and characterization; not tested in production.

**Calibration Description**

CT452-x00DR is factory trimmed for sensitivity and offset temperature drift. The sensor provides the ability to adjust gain to allow for all the mechanical tolerances during manufacturing. Gain calibration is recommended to be performed at room-temperature ( $25^\circ\text{C}$ ) using Crocus Technology's CTC4000 Calibration Box.

## Circuit Description

The CT452 is a very high accuracy differential, coreless and contactless current sensor that can sense magnetic fields from 6 mT to 24 mT. It has very high sensitivity and a wide dynamic range with excellent accuracy (very low total output error) across temperature. This current sensor supports two (2) field ranges as standard and can also be user-programmable up to 24mT:

- 0 mT to +6 mT
- -6 mT to +6 mT

CT452 is also available in a user-programmable variant, which enables end-of-line calibration of gain. While the sensor is pre-programmed to adjust sensitivity and offset temperature drift. The ability to adjust gain relaxes mechanical tolerances during sensor mounting.

When current is flowing through a busbar above or below the CT452, the XtremeSense TMR sensor inside the chip senses the field which in turn generates a differential voltage signals that then goes through the Analog Front-End (AFE) to output a current measurement as low as  $\pm 1.0\%$  full-scale (FS) total output error ( $E_{OUT}$ ).

The chip is designed to enable a very fast response time of 300 ns for the current measurement from the OUT pin as the bandwidth for the CT452 is 1.0 MHz. Even with a high bandwidth, the chip consumes a minimal amount of power.

## Linear Output Magnetic Field Measurement

The CT452 provides a continuous linear analog output voltage which represents the magnetic field generated by the current flowing through the busbar. The output voltage range of OUT is from 0.50 V to 4.50 V with a  $V_{OQ}$  of 0.50 V and 2.50 V for unidirectional and bidirectional fields, respectively. Figure 15 illustrates the output voltage range of the OUT pin as a function of the measured field.

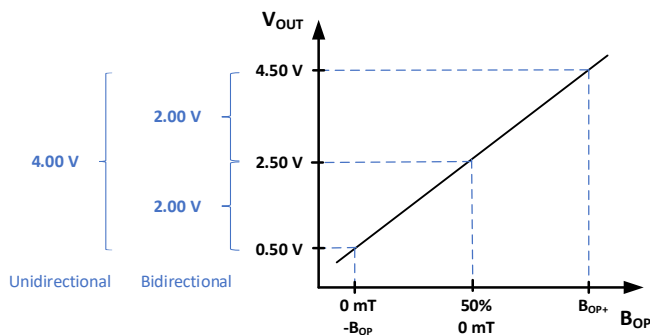

Figure 15. Linear Output Voltage Range (OUT) vs. Measured Magnetic Field ( $B_{OP}$ )

## Voltage Reference Function (VREF)

The CT452 in TSSOP-8 package has a reference voltage (VREF) pin that may be used as an output voltage reference for AC or DC field/current measurements. The VREF pin should be connected to a buffer circuit.

If the VREF is not used, then it should be left unconnected.

## Filter Function (FILTER)

The CT452 in both packages has a pin for the FILTER function which will enable it to improve the noise performance by changing the cut-off frequency. The bandwidth of the CT452 is 1.0 MHz, however by adding a capacitor to the FILTER pin which, will be in series with an internal resistance of approximately 15 k $\Omega$ , will set the cut-off frequency to reduce the noise. Figure 16 shows the capacitor values required to achieve different cut-off frequencies.

Experimentally measured bandwidth does not necessarily match the calculated bandwidth value by using the equation  $f_{BW} = 1/2\pi RC$  because of the parasitic capacitances due to PCB manufacturing and layout. This is further impacted by the small, pico-Farad level  $C_{FILTER}$  recommendations.

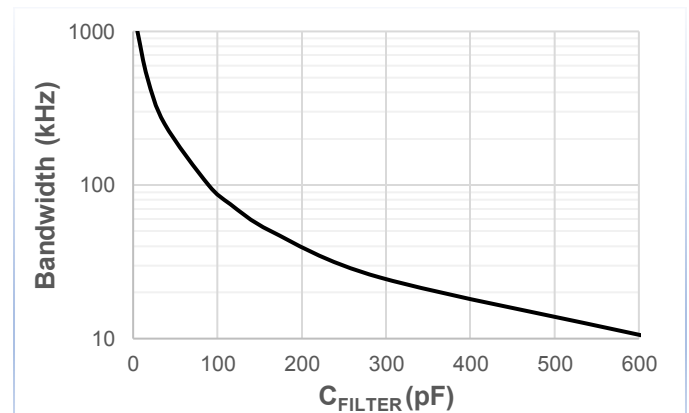

Figure 16 Bandwidth vs.  $C_{FILTER}$

## Total Output Error

The Total Output Error is the difference between the magnetic field measured by CT452 and the actual field, relative to the actual field. It is equivalent to the ratio between the difference of the ideal and actual voltage to the ideal sensitivity multiplied by the magnetic field due to current flowing through the busbar. The equation below defines the Total Output Error ( $E_{OUT}$ ) for the CT452:

$$E_{OUT} = 100 * \frac{V_{OUT\_IDEAL}(B_{OP}) - V_{OUT}(B_{OP})}{S_{IDEAL} \times B_{OP}(FS)}$$

The  $E_{OUT}$  incorporates all sources of error and is a function of the sensed magnetic field ( $B_{OP}$ ) from CT452. At high field levels, the  $E_{OUT}$  will be dominated by the sensitivity error whereas at low fields, the dominant characteristic is the offset voltage. Figure 17 shows the behavior of  $E_{OUT}$  versus  $B_{OP}$ . When  $B_{OP}$  goes 0 from both directions, the curves exhibit asymptotic behavior (i.e.  $E_{OUT}$  approaches infinity).

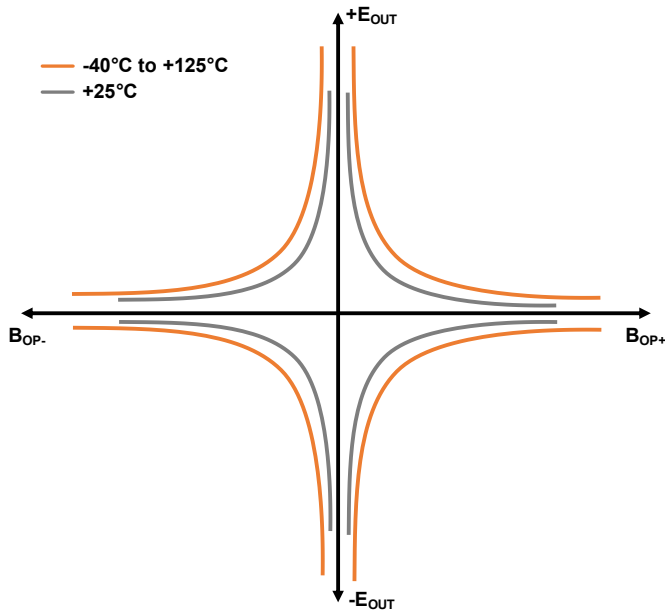

**Figure 17. Total Output Error ( $E_{OUT}$ ) vs. Field ( $B_{OP}$ )**

The CT452 achieves, after gain calibration, a total output error ( $E_{OUT}$ ) that is less than  $\pm 1.0\%$  of Full-Scale (FS) over supply voltage and temperature. It is designed with innovative and proprietary TMR sensors and circuit blocks to provide very accurate magnetic field measurements regardless of the operating conditions.

## Common Mode Field Rejection (CMFR) Mode

The CT452 has a built-in CMFR mode that combines the design ease of contactless current sensing with excellent common mode field rejection. This is achieved by placing notches in the current carrying busbar or PCB trace to generate a differential magnetic field in the vicinity of the CT452 sensor. The current sensor utilizes two full-bridge XtremeSense TMR sensors to achieve differential magnetic sensing capability, which allows the CT452 to greatly attenuate external magnetic fields and only capture the magnetic field generated by the current flowing in the busbar. Using this technique achieves better than  $-50$  dB of CMFR without compromising the accuracy or the Signal-to-Noise Ratio (SNR) of the CT452.

Figure 18 (and Figure 19) shows an example of a 2-layer Printed Circuit Board (PCB) where the CT452 is placed on the top layer of the PCB and the bottom layer is designed to generate differential magnetic fields as the current flows through this trace. The “snake like” shape of the PCB trace produces the differential magnetic fields that almost completely eliminates the effects of stray magnetic fields to the CT452. This ensures that the CT452 outputs an accurate output voltage/current measurement to the host system.

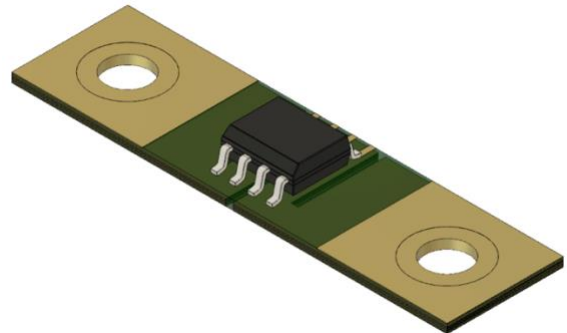
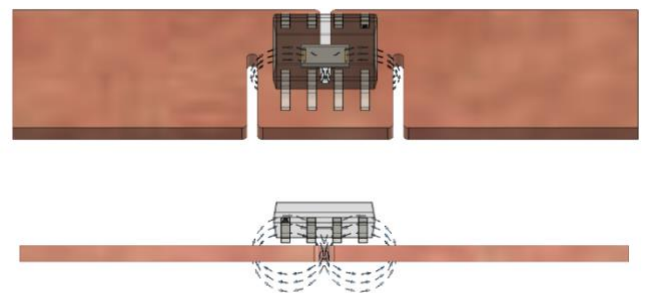

**Figure 18. 3D View of CT452 and PCB Trace Design**



**Figure 19. PCB Trace Design to Generate Differential Magnetic Field for CT452 to Measure**

An exploded view of the differential magnetic field generated by the PCB trace is illustrated in Figure 20. It demonstrates the IP+ current generating a clockwise field and going around the bend or corner of the trace and coming out is IP- with a counter-clockwise field.



**Figure 20. Differential Magnetic Fields Generated Current Through the Busbar (or PCB Trace) and Measured by the CT452**



This concept is not restricted to PCB layers and can be extended to busbars carrying current in the hundreds to thousands of Amperes. Figure 21 shows a graphic of the CT452 placed over a busbar that generates differential magnetic fields when 300 A or greater steady-state current through it which will also give CMFR ratio of -50 dB or greater than 90% immunity.

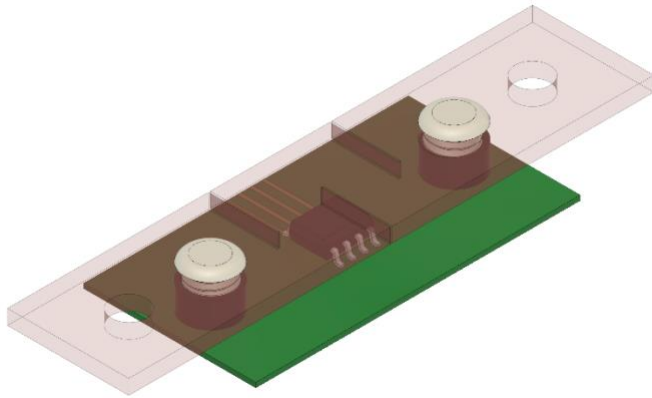

**Figure 21. CT452 for Contactless Current Sensing Using Busbar**

For more information on how to design the PCB trace and busbar to achieve this CMFR performance, please see the application note AN134, The CT452/CT453 Reference Design Guide for Contactless Current Sensing.

## Sensitivity Error

The sensitivity error ( $E_{SENS}$ ) is the sensitivity temperature drift error for unipolar field or DC current. It is calculated using the equation below:

$$E_{SENS} = \left( \frac{S_{MEASURED}}{S} - 1 \right) \times 100\%$$

For bipolar field or AC current, the  $E_{SENS}$  is calculated by dividing the equation by 2.

## Power-On Time ( $t_{ON}$ )

The Power-On Time ( $t_{ON}$ ) of 100  $\mu$ s is the amount of time required by CT452 to start up, fully power the chip and becoming fully operational from the moment the supply voltage is greater than the UVLO voltage. This time includes the ramp up time and the settling time (within 10% of steady-state voltage under an applied magnetic field) after the power supply have reach the minimum  $V_{CC}$ .

## Response Time ( $t_{RESPONSE}$ )

The Response Time ( $t_{RESPONSE}$ ) of 300 ns for the CT452 is the time interval between the following terms:

1. When the primary field/current signal reaches 90% of its final value,
2. When the chip reaches 90% of its output corresponding to the applied field/current.

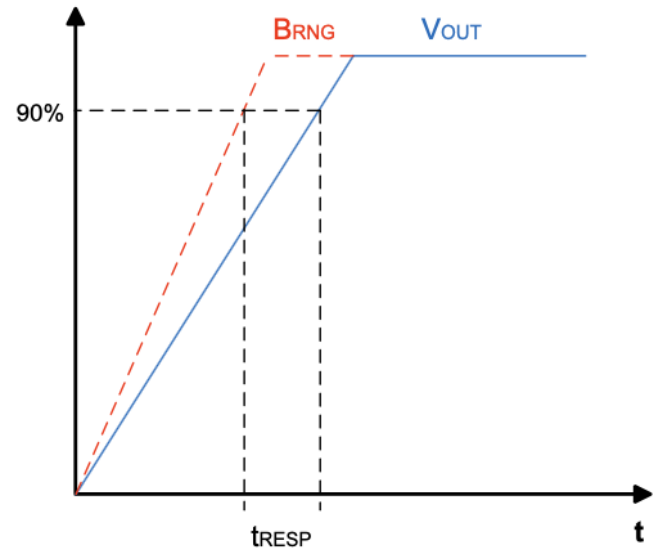

**Figure 22. CT452 Response Time Curve**

## Rise Time ( $t_{RISE}$ )

The CT452's rise time,  $t_{RISE}$ , is the time interval of when it reaches 10% and 90% of the full-scale output voltage. The  $t_{RISE}$  of the CT452 is 200 ns.

## Propagation Delay ( $t_{DELAY}$ )

The Propagation Delay ( $t_{DELAY}$ ) is the time difference between these two events:

1. When the primary current reaches 20% of its final value
2. When the chip reaches 20% of its output corresponding to the applied field/current.

The CT452 has a propagation delay of 250 ns.

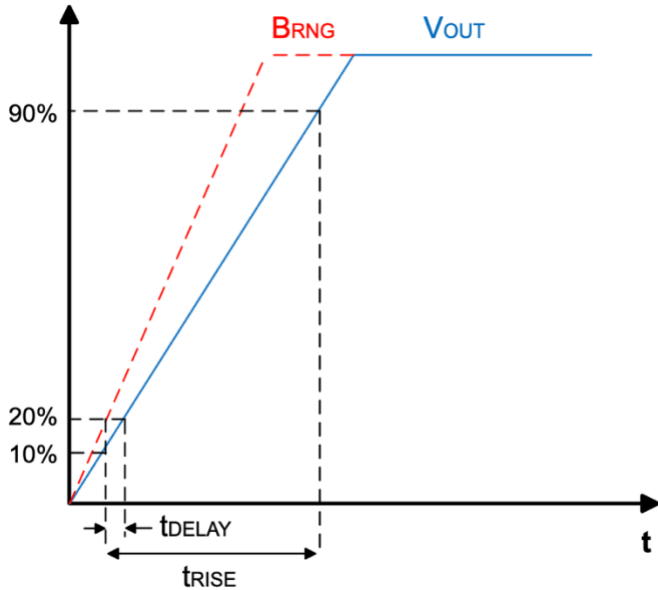

**Figure 23. CT452 Propagation Delay and Rise Time Curve**

## Under-Voltage Lockout (UVLO)

The Under-Voltage Lock-out protection circuitry of the CT452 is activated when the supply voltage ( $V_{CC}$ ) falls below 2.45 V. The CT452 remains in a low quiescent state until  $V_{CC}$  rises above the UVLO threshold (2.50 V). In this condition where the  $V_{CC}$  is less than 2.45 V and UVLO is triggered, the output from the CT452. Once the  $V_{CC}$  rises above 4.0 V then the UVLO is cleared.

## Recommended PCB Trace Design

The CT452 requires a different PCB trace or busbar design than the standard current trace or busbar to enable common mode field rejection. Figure 24 and Figure 25 show the shape and design of a PCB trace or busbar.

Other considerations in the PCB layout include the thickness of the trace and the amount of copper to support the current. Also placing the PCB trace on the bottom layer of the board will increase the isolation voltage. The greater distance between the CT452 and the current trace will result in a higher isolation voltage.

For more information on how to design the current-carrying busbar or PCB trace, please see the AN135 application note.

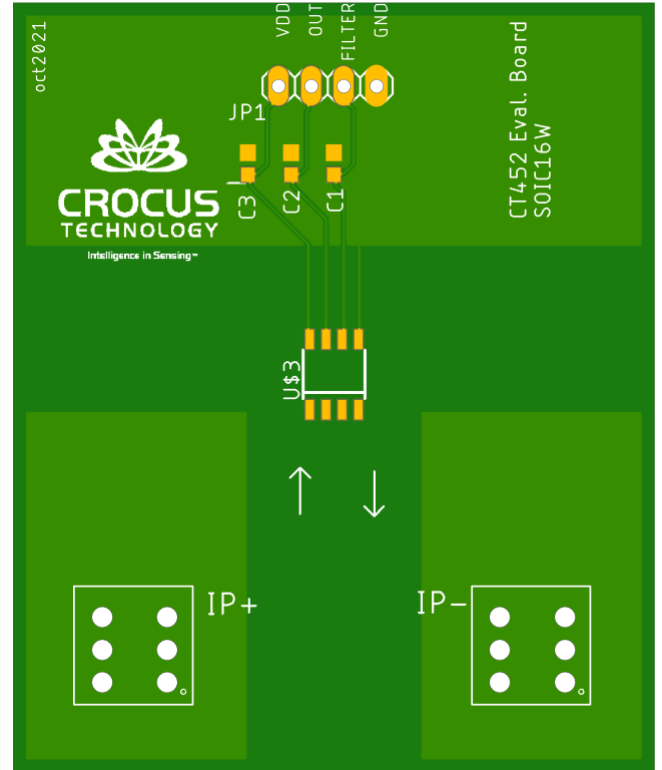

**Figure 24. Recommended PCB Layout (Top Layer) for CT452**

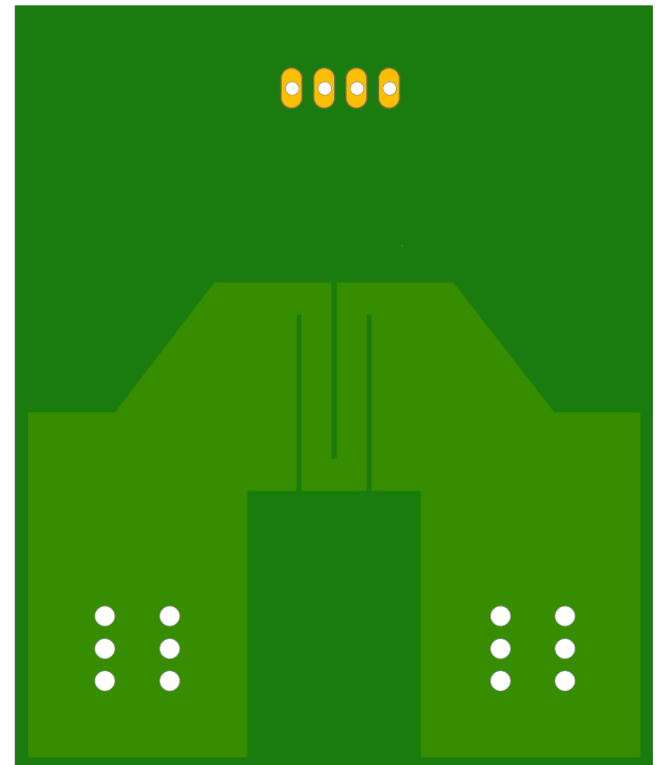

**Figure 25. Recommended PCB Layout (Bottom Layer) for CT452**

## XtremeSense® TMR Current Sensor Location

The XtremeSense TMR current sensor location of the CT452 is shown below. All dimensions in the figures are nominal.

### SOIC-8 Package

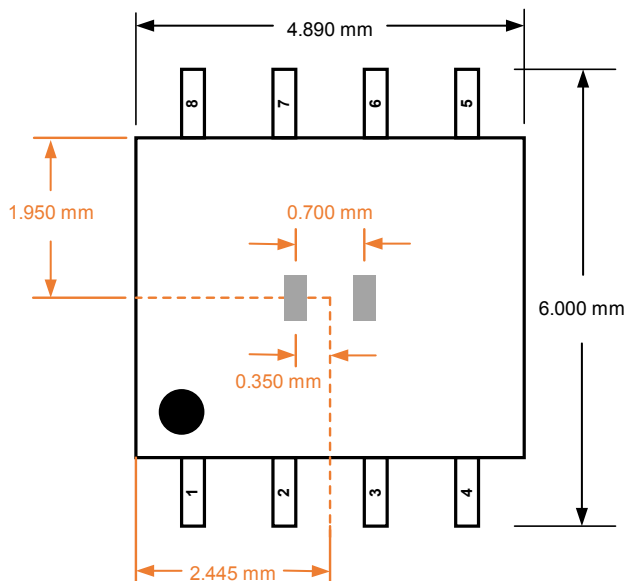

Figure 26. XtremeSense TMR Current Sensor Location in x-y Plane for CT452 in SOIC-8 Package

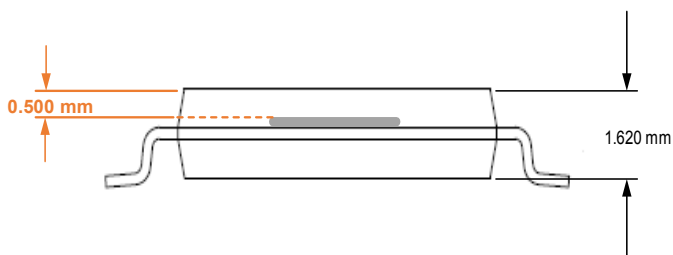

Figure 27. XtremeSense TMR Current Sensor Location in z Dimension for CT452 in SOIC-8 Package

### TSSOP-8 Package

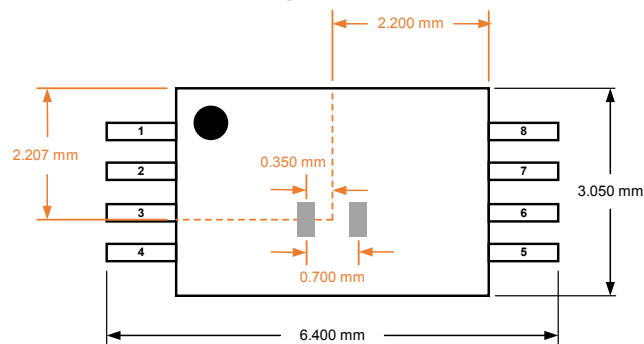

Figure 28. XtremeSense TMR Current Sensor Location in x-y Plane for CT452 in TSSOP-8 Package

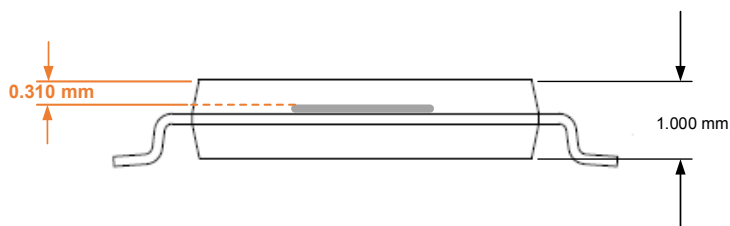
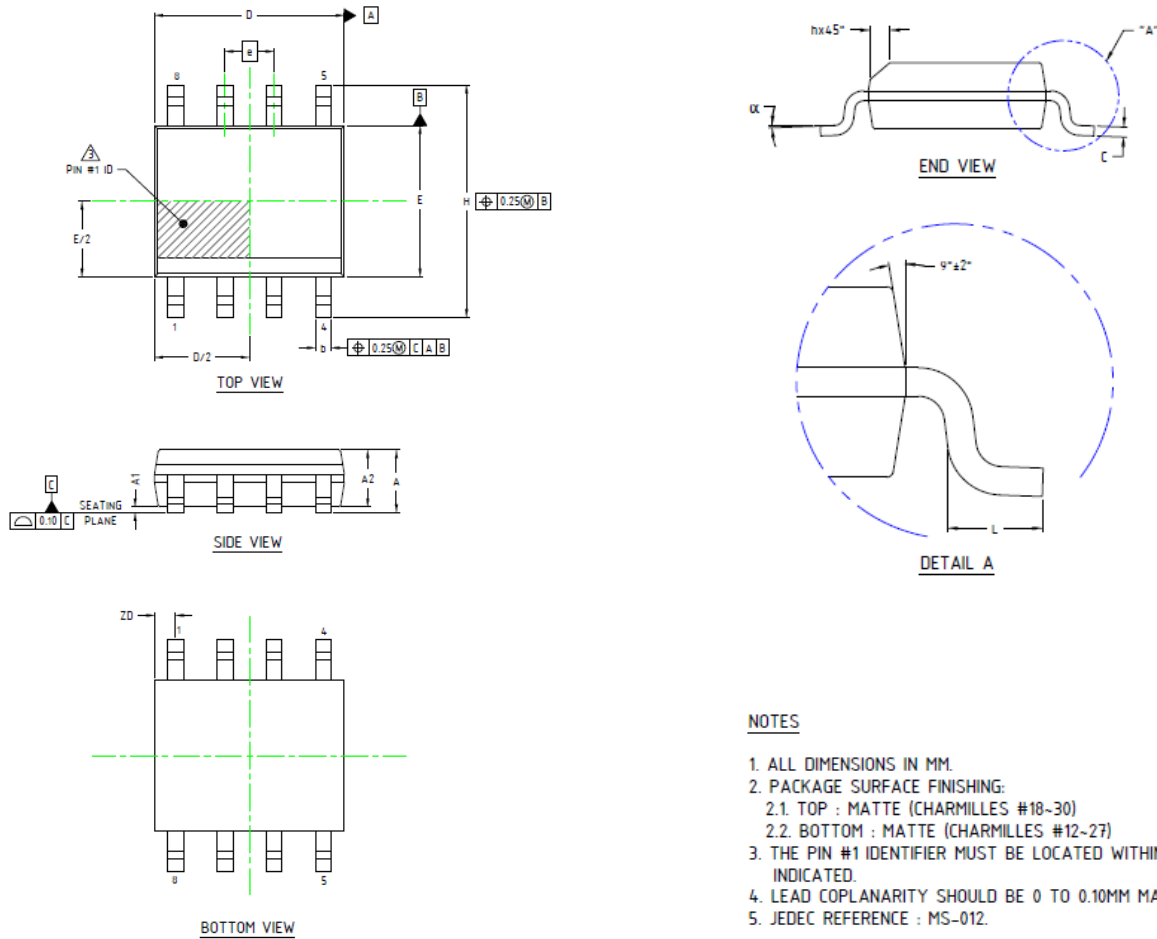

Figure 29. XtremeSense TMR Current Sensor Location in z Dimension for CT452 in TSSOP-8 Package

SOIC-8 Package Drawing and Dimensions



- NOTES**
1. ALL DIMENSIONS IN MM.
  2. PACKAGE SURFACE FINISHING:
    - 2.1. TOP : MATTE (CHARMILLES #18-30)
    - 2.2. BOTTOM : MATTE (CHARMILLES #12-27)
  3. THE PIN #1 IDENTIFIER MUST BE LOCATED WITHIN THE ZONE INDICATED.
  4. LEAD COPLANARITY SHOULD BE 0 TO 0.10MM MAX.
  5. JEDEC REFERENCE : MS-012.

Figure 30. SOIC-8 Package Drawing

Table 3. CT452 SOIC-8 Package Dimensions

Symbol	Dimensions in Millimeters (mm)		
	Min.	Typ.	Max.
A1	0.10	0.18	0.25
b	0.36	0.41	0.46
C	0.19	0.22	0.25
D	4.80	4.89	4.98
E	3.81	3.90	3.99
e	1.27 BSC		
H	5.80	6.00	6.20
h	0.25	0.37	0.50
L	0.41	-	1.27
A	1.52	1.62	1.72
α	0°	-	8°
ZD	0.53 REF		
A2	1.37	1.47	1.57

Crocus Technology provides package drawings as a service to customers considering or planning to use Crocus products in their designs. Drawings may change without notice. Please note the revision and date of the data sheet and contact a Crocus Technology representative to verify or obtain the most recent version. The package specifications do not expand the terms of Crocus Technology’s worldwide terms and conditions, specifically the warranty therein, which covers Crocus Technology’s products.

## SOIC-8 Tape & Pocket Drawing and Dimensions

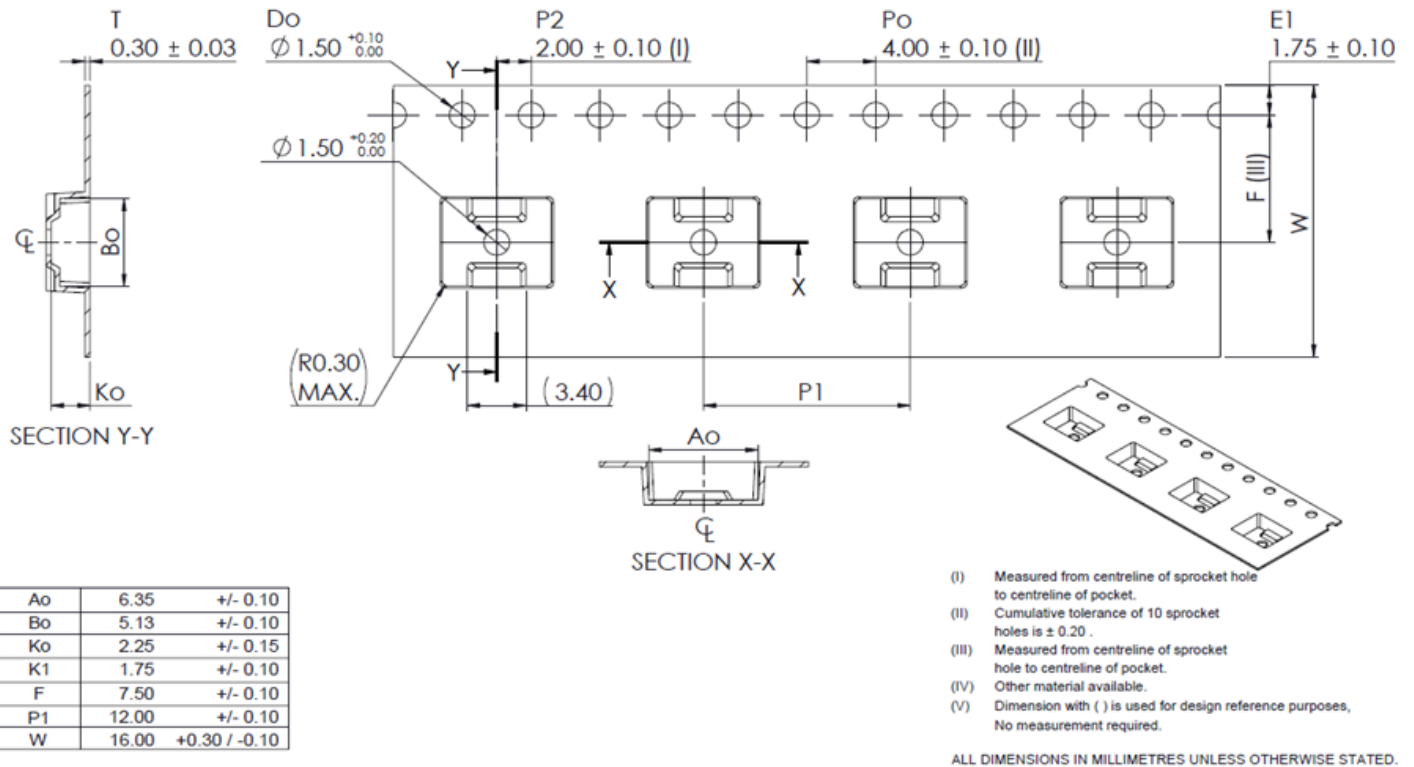

Figure 31. SOIC-8 Package Drawing

## TSSOP-8 Package Drawing and Dimensions

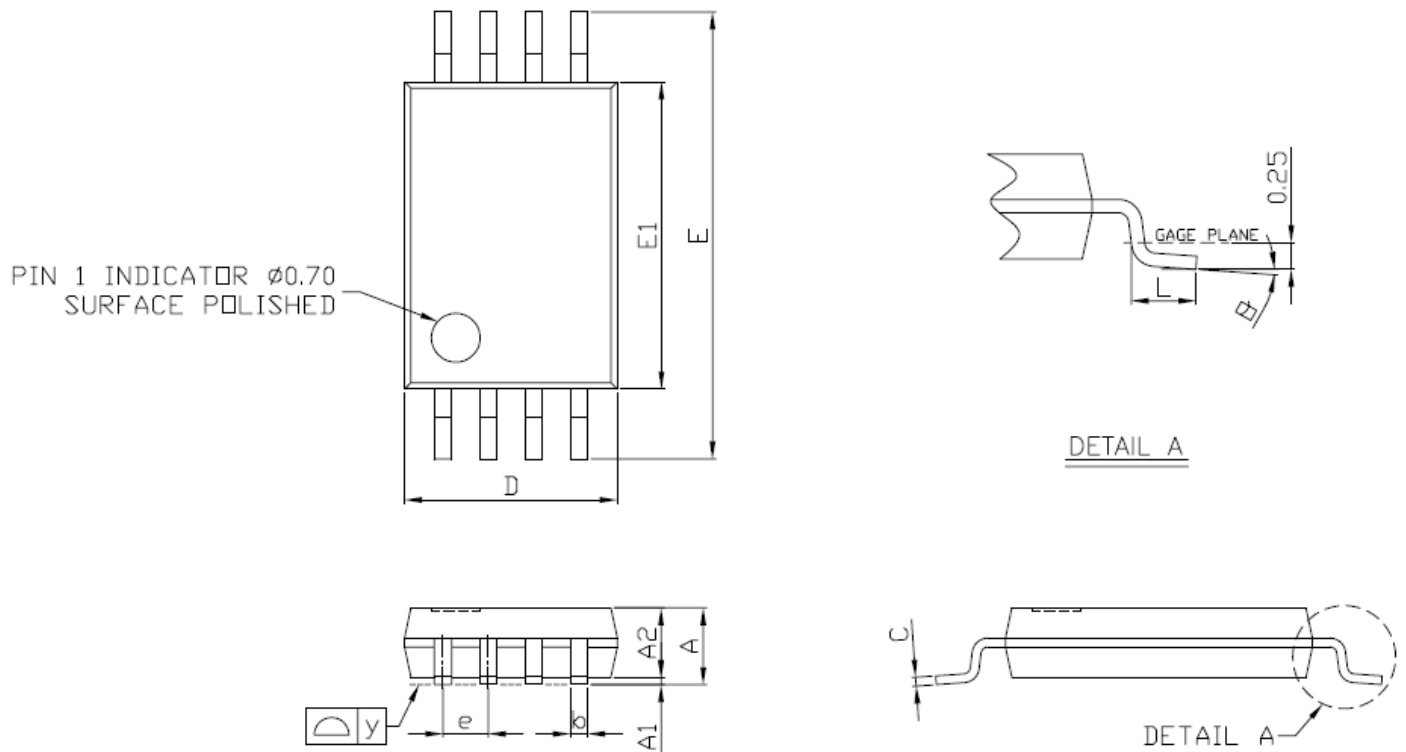

Figure 32. TSSOP-8 Package Drawing

Table 4. CT452 TSSOP-8 Package Dimensions

Symbol	Dimensions in Millimeters (mm)		
	Min.	Typ.	Max.
A	1.05	1.10	1.20
A1	0.05	0.10	0.15
A2	-	1.00	1.05
b	0.25	-	0.30
C	-	0.127	-
D	2.90	3.05	3.10
E	6.20	6.40	6.60
E1	4.30	4.40	4.50
e	-	0.65	-
L	0.50	0.60	0.70
y	-	-	0.076
θ	0°	4°	8°

Crocus Technology provides package drawings as a service to customers considering or planning to use Crocus products in their designs. Drawings may change without notice. Please note the revision and date of the data sheet and contact a Crocus Technology representative to verify or obtain the most recent version. The package specifications do not expand the terms of Crocus Technology's worldwide terms and conditions, specifically the warranty therein, which covers Crocus Technology's products.

TSSOP-8 Tape & Pocket Drawing and Dimensions

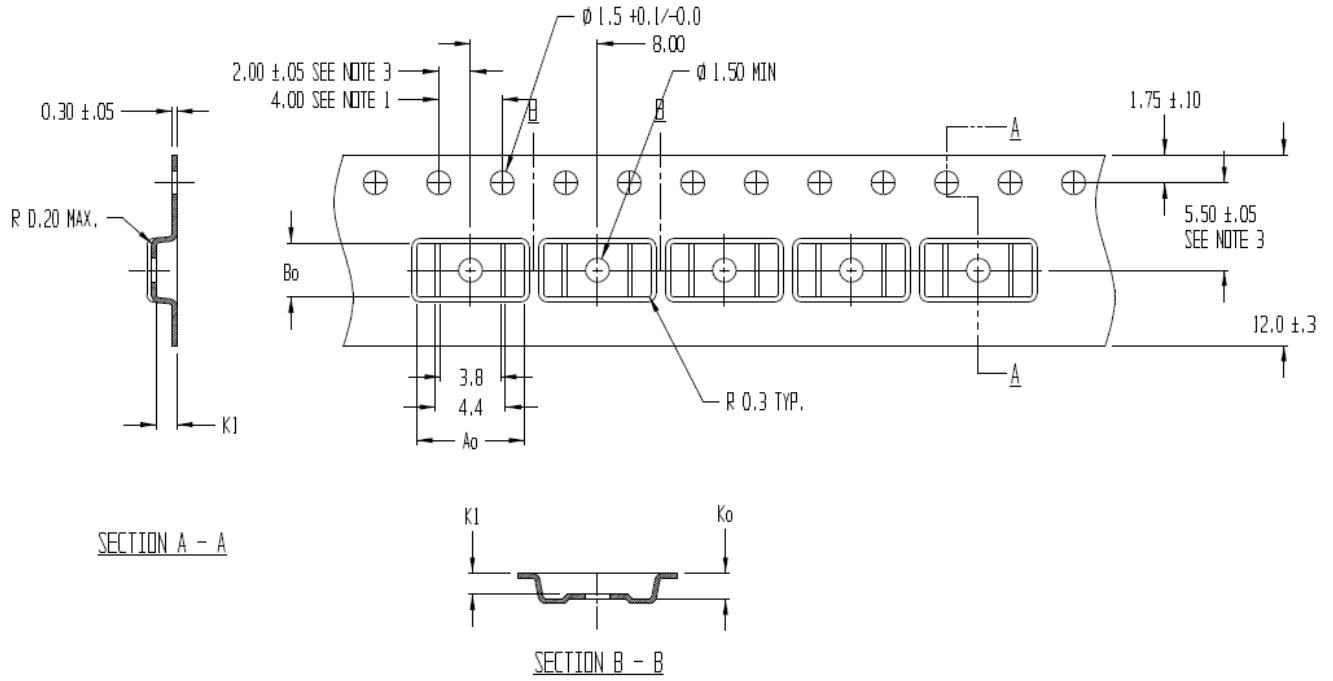

NOTES:

1. 10 SPROCKET HOLE PITCH CUMULATIVE TOLERANCE  $\pm 0.2$
2. CAMBER IN COMPLIANCE WITH EIA 481
3. POCKET POSITION RELATIVE TO SPROCKET HOLE MEASURED AS TRUE POSITION OF POCKET, NOT POCKET HOLE

$A_0 = 6.80$   
 $B_0 = 3.40$   
 $K_0 = 1.60$   
 $K_1 = 1.30$

Figure 33. TSSOP-8 Tape and Pocket Drawings

## Package Information

Table 5. CT452 Package Information

Part Number	Package Type	# of Leads	Quantity per Reel	Lead Finish	MSL Rating <sup>(2)</sup>	Operating Temperature <sup>(3)</sup>	Device Marking <sup>(4)</sup>
CT452-H06MRTS08	TSSOP	8	3,000	Sn	1	-40°C to +125°C	CT452-06MR YYWWLL
CT452-H06MRSN08	SOIC	8	3,000	Sn	3	-40°C to +125°C	CT452-06MR YYWWLL
CT452-H06DRTS08	TSSOP	8	3,000	Sn	1	-40°C to +125°C	CT452-06DR YYWWLL
CT452-H06DRSN08	SOIC	8	3,000	Sn	3	-40°C to +125°C	CT452-06DR YYWWLL
CT452-H00MRTS08	TSSOP	8	3,000	Sn	1	-40°C to +125°C	CT452-00MR YYWWLL
CT452-H00DRTS08	TSSOP	8	3,000	Sn	1	-40°C to +125°C	CT452-00DR YYWWLL
CT452-H00MRSN08	SOIC	8	3,000	Sn	3	-40°C to +125°C	CT452 00MR YYWWLL
CT452-H00DRSN08	SOIC	8	3,000	Sn	3	-40°C to +125°C	CT452 00DR YYWWLL
CT452-A00MRTS08	TSSOP	8	3,000	Sn	1	-40°C to +125°C	CT452-A00MR YYWWLL
CT452-A00DRTS08	TSSOP	8	3,000	Sn	1	-40°C to +125°C	CT452-A00DR YYWWLL
CT452-A00MRSN08	SOIC	8	3,000	Sn	3	-40°C to +125°C	CT452 A00MR YYWWLL
CT452-A00DRSN08	SOIC	8	3,000	Sn	3	-40°C to +125°C	CT452 A00DR YYWWLL

- (1) RoHS is defined as semiconductor products that are compliant to the current EU RoHS requirements. It also will meet the requirement that RoHS substances do not exceed 0.1% by weight in homogeneous materials. Green is defined as the content of Chlorine (Cl), Bromine (Br) and Antimony Trioxide based flame retardants satisfy JS709B low halogen requirements of  $\leq 1,000$  ppm.
- (2) MSL Rating = Moisture Sensitivity Level Rating as defined by JEDEC standard classifications.
- (3) Package will withstand ambient temperature range of -40°C to +125°C and storage temperature range of -65°C to +150°C.
- (4) Device Marking for CT452 in SOIC-8 is defined as CT452 xxZR YYWWLL where the first 2 lines = part number, and third line is YY = year, WW = work week and LL = lot code. In TSSOP-8 is defined as CT452 xxZR YYWWLL where the first line = part number, and second line is YY = year, WW = work week and LL = lot code.



## Device Marking

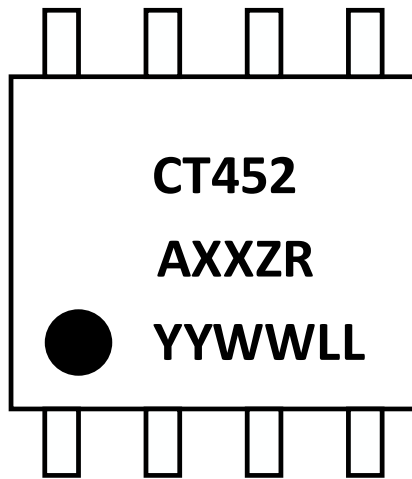

Figure 34. CT452 Device Marking for 8-lead SOIC Package

Row No.	Code	Definition
3	•	Pin 1 Indicator
1	CT452	Crocus Part Number
2	A	Automotive Identifier
2	XX	Maximum Field Rating
2	ZR	Polarity
3	YY	Calendar Year
3	WW	Work Week
3	LL	Lot Code

Table 6. CT452 Device Marking Definition for 8-lead SOIC Package

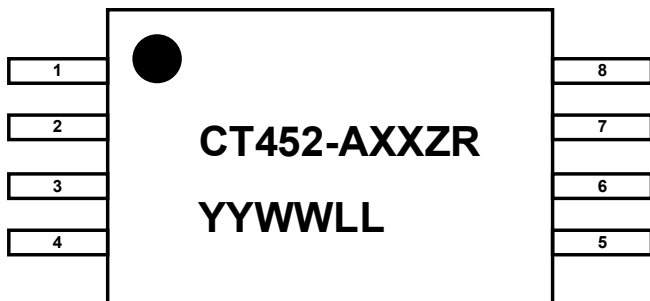

Figure 35. CT452 Device Marking for 8-lead TSSOP Package

Row No.	Code	Definition
1	•	Pin 1 Indicator
2	CT452	Crocus Part Number
2	A	Automotive Identifier
2	XX	Maximum Magnetic Field Rating
2	ZR	Magnetic Field Range
3	YY	Calendar Year
3	WW	Work Week
3	LL	Lot Code

Table 7. CT452 Device Marking Definition for 8-lead TSSOP Package