



CT432

XtremeSense® TMR Current Sensor with High dV/dt Immunity, 5kV Isolation and Common-Mode Field Rejection

FEATURES

- Integrated Contact Current Sensing for Low to Medium Current Ranges:
 - 0 A to +20 A
 - -20 A to +20 A
 - 0 A to +30 A
 - -30 A to +30 A
 - 0 A to +50 A
 - -50 A to +50 A
 - 0 A to +65 A
 - -65 A to +65 A
- Optimized for high dV/dt applications
- Integrated Current Carrying Conductor (CCC)
- Linear Analog Output Voltage
- Total Error Output $\leq \pm 1.0\%$ FS, -40°C to $+125^{\circ}\text{C}$
- 1 MHz Bandwidth
- Response Time: ~ 300 ns
- UL/IEC 62368-1 and UL1577 Certification
 - Rated Isolation Voltage: 5 kV_{RMS}
 - Working Voltage for Basic Isolation: $1287\text{ V}_{\text{RMS}}$
 - Working Voltage for Reinforced Isolation: $647\text{ V}_{\text{RMS}}$
- IEC 61000-4-5 Certified
- Low Noise: 9 mA_{RMS} to $15\text{ mA}_{\text{RMS}}$ @ $f_{\text{BW}} = 100\text{ kHz}$
- Immunity to Common Mode Fields: -54 dB
- Supply Voltage: 4.75 to 5.50 V
- AEC-Q100 Grade 1 (Under Qualification)

PRODUCT DESCRIPTION

The CT432 is a high bandwidth and ultra-low noise integrated contact current sensor that uses Crocus Technology's patented XtremeSense® TMR technology to enable high accuracy current measurements for many consumer, enterprise, and industrial applications. It supports multiple current ranges where the integrated current carrying conductor (CCC) will handle up to 65 A of current and generates a current measurement as a linear analog output voltage. It achieves a total output error of less than $\pm 1.0\%$ full-scale (FS) over supply voltage and the full temperature range.

It has about a 300 ns output response time while the current consumption is about 6.0 mA and is immune to common mode fields. The CT432 was optimized for high dV/dt applications which minimizes capacitive coupling to V_{OUT} allowing CT432 to be used in switching applications.

The CT432 is offered in an industry standard 16-lead SOIC-Wide package that is "green" and RoHS compliant.

APPLICATIONS

- Power Inverters
- UPS, SMPS and Telecom Power Supplies
- Motor Control
- Over-Current Fault Protection

PACKAGE: 16-lead SOICW



TÜV Certificate No.:
R 72226133 0001



UL Certificate No.:
UL-CA-2201235-0

Part Ordering Information

Part Number	Current Range (I _{PMAX})	Sensitivity (mV/A)	Operating Temperature Range	Package	Packing Method
CT432-HSWF20MR	±20	100	-40°C to +125°C	16-lead SOIC-Wide 10.21 x 10.31 x 2.54 mm	Tape & Reel
CT432-HSWF30MR	±30	66.7			
CT432-HSWF50MR	±50	40			
CT432-HSWF65MR	±65	30.8			
CT432-HSWF20DR	20	200			
CT432-HSWF30DR	30	133.3			
CT432-HSWF50DR	50	80			
CT432-HSWF65DR	65	61.5			
AEC-Q100 Grade 1					
CT432-ASWF20MR	±20	100	Grade 1 -40°C to +125°C	16-lead SOIC-Wide 10.21 x 10.31 x 2.54 mm	Tape & Reel
CT432-ASWF30MR	±30	66.7			
CT432-ASWF50MR	±50	40			
CT432-ASWF65MR	±65	30.8			
CT432-ASWF20DR	20	200			
CT432-ASWF30DR	30	133.3			
CT432-ASWF50DR	50	80			
CT432-ASWF65DR	65	61.5			

Evaluation Board Ordering Information

Part Number	Current Range	Operating Temperature Range
CTD432-20U	0 A to +20 A	-40°C to +125°C
CTD432-20B	-20 A to +20 A	
CTD432-30U	0 A to +30 A	
CTD432-30B	-30 A to +30 A	
CTD432-50U	0 A to +50 A	
CTD432-50B	-50 A to +50 A	
CTD432-65U	0 A to +65 A	
CTD432-65B	-65 A to +65 A	

Block Diagram

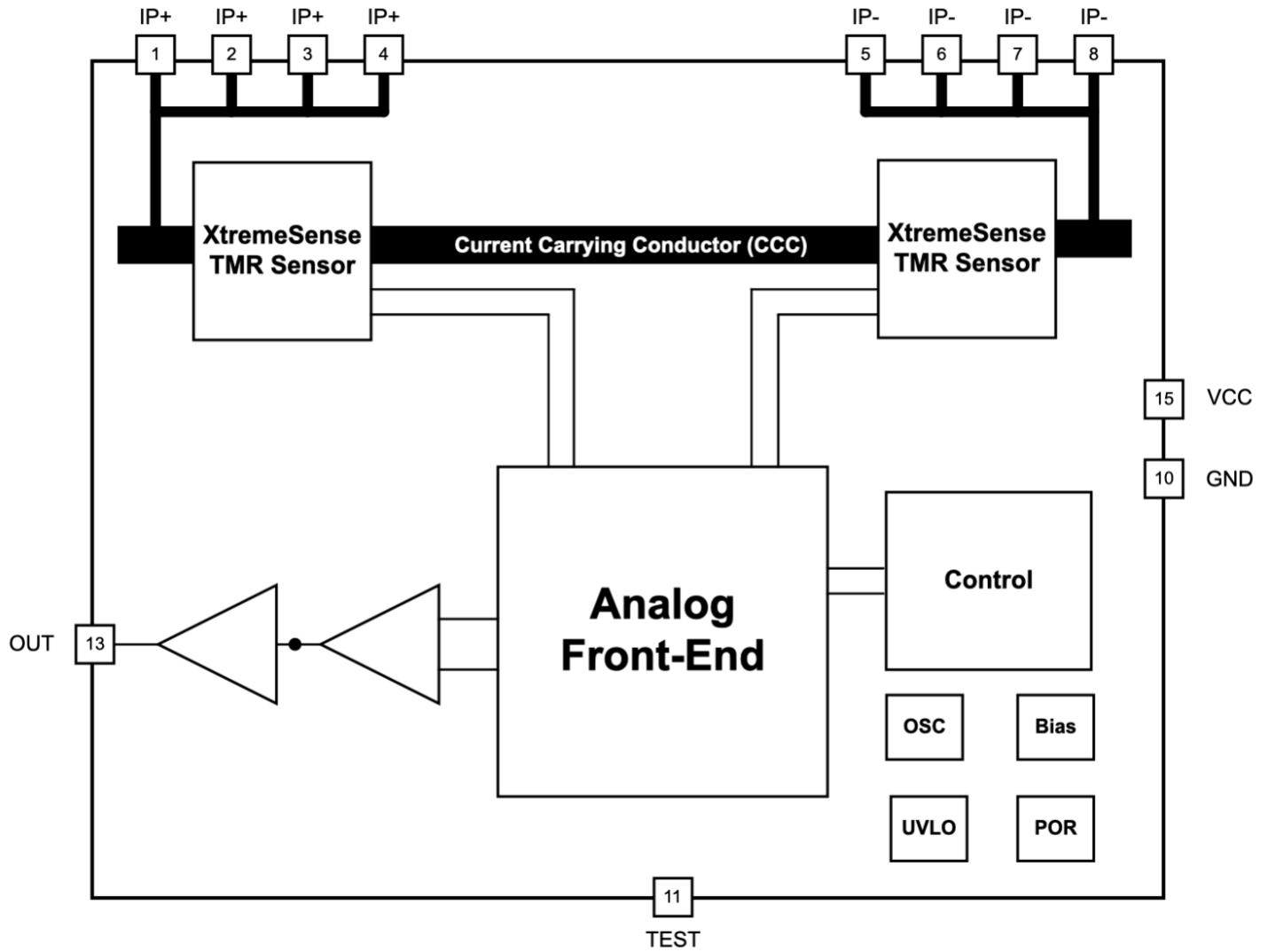

Figure 1. CT432 Functional Block Diagram for 16-lead SOIC-Wide Package

CT432 Pin Configuration

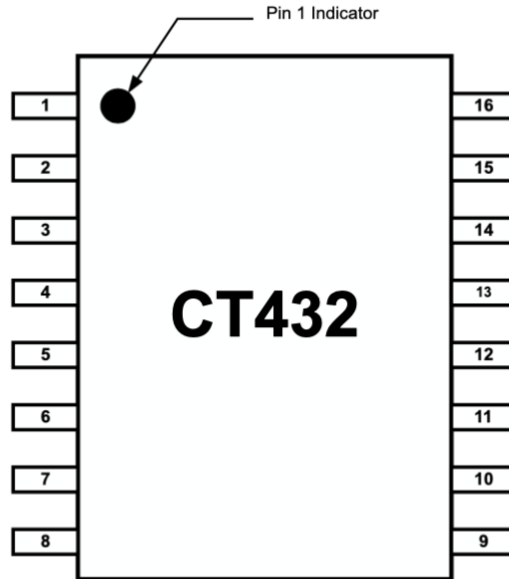

Figure 2. CT432 Pin-out Diagram for 16-lead SOIC-Wide Package (Top-Down View)

Pin Definition

Pin #	Pin Name	Pin Description
1	IP+	Terminal for primary conductor (positive).
2		
3		
4		
5	IP-	Terminal for primary conductor (negative).
6		
7		
8		
9	N/C	No connect.
10	GND	Ground.
11	TEST	Pin used for factory calibration. Connect to Ground.
12	N/C	No connect.
13	OUT	Analog output voltage that represents the measured current.
14	N/C	No connect.
15	VCC	Supply voltage.
16	N/C	No connect.

Absolute Maximum Ratings

Stresses exceeding the absolute maximum ratings may damage the CT432 and may not function or be operable above the recommended operating conditions and stressing the parts to these levels is not recommended. In addition, extended exposure to stresses above the recommended operating conditions may affect device reliability. The absolute maximum ratings are stress ratings only.

Symbol	Parameter	Min.	Max.	Unit
V _{CC}	Supply Voltage	-0.3	6.0	V
V _{I/O}	Analog Input/Output Pins Maximum Voltage	-0.3	V _{CC} + 0.3*	V
I _{CC(MAX)}	Current Carrying Conductor, T _A = +25°C		70	A
V _{SURGE}	Dielectric Surge Strength Test Voltage	IEC 61000-4-5 : Tested ±5 Pulses at 2/60 seconds, 1.2 μs (rise) and 50 μs (width)		kV
I _{SURGE}	Surge Strength Test Current	Tested ±5 Pulses at 3/60 seconds, 8.0 μs (rise) and 20 μs (width)		kA
ESD	Electrostatic Discharge Protection Level	Human Body Model (HBM) per JESD22-A114		kV
		Charged Device Model (CDM) per JESD22-C101		
T _J	Junction Temperature	-40	+150	°C
T _{STG}	Storage Temperature	-65	+155	°C
T _L	Lead Soldering Temperature, 10 Seconds		+260	°C

*The lower of V_{CC} + 0.3 V or 6.0 V.

Recommended Operating Conditions

The Recommended Operating Conditions table defines the conditions for actual operation of the CT432. Recommended operating conditions are specified to ensure optimal performance to the specifications. Crocus Technology does not recommend exceeding them or designing to absolute maximum ratings.

Symbol	Parameter	Min.	Typ.	Max.	Unit	
V _{CC}	Supply Voltage Range	4.75	5.00	5.50	V	
V _{OUT}	OUT Voltage Range	0		V _{CC}	V	
I _{OUT}	OUT Current			±1.0	mA	
T _A	Operating Ambient Temperature	Industrial	-40	+25	+85	°C
		Extended Industrial	-40	+25	+125	
		Automotive	-40	+25	+125	

Isolation Ratings

Symbol	Parameter	Conditions	Rating	Unit
V _{ISO}	Rated Isolation Voltage	Agency Tested per IEC 62368* for 60 seconds. Production Tested at V _{ISO} for 1 second per IEC 62368.	5.0	kV _{RMS}
		Agency Tested per UL1577 for 60 seconds. Production Tested at V _{ISO} for 1 second per UL1577.	5.0	kV _{RMS}
V _{WORK_ISO}	Working Voltage for Basic Isolation	Tested per per IEC 62368*	1820	V _{PK}
			1287	V _{RMS}
V _{WORK_RI}	Working Voltage for Reinforced Isolation	Tested per IEC 62368*	915	V _{PK}
			647	V _{RMS}
d _{CR}	Creepage Distance	Minimum Distance Along Package Body from IP Pins to I/O Pins	9.21	mm
d _{CL}	Clearance Distance	Minimum Distance Through Air from IP Pins to I/O Pins	8.79	mm
d _{ISO}	Distance Through Isolation	Minimum Internal Distance Through Isolation	110	μm
CTI	Comparative Tracking Index	Material Group II	400 to 599	V

*IEC 62368 is the succeeding standard to IEC 60950-1 (Edition 2) for isolation testing specifications and as such it will be compliant to the latter standard.

CMTI Rating

Common Mode Transient Immunity defines how the sensor's output changes under a high dV/dt event.

Symbol	Parameter	Conditions	Rating	Unit
CMTI	Common Mode Transient Immunity	The failure criterion is that the output peak is greater than 100mV, and the duration is longer than 1us	100	kV/μs

Thermal Properties

Junction-to-ambient thermal resistance is a function of application and board layout and is determined in accordance to JEDEC standard JESD51 for a four (4) layer 2s2p FR-4 printed circuit board (PCB) with 4 oz. of copper (Cu). Special attention must be paid not to exceed junction temperature T_{J(MAX)} at a given ambient temperature T_A.

Symbol	Parameter	Min.	Typ.	Max.	Unit
θ _{JA_SOICW}	Junction-to-Ambient Thermal Resistance, SOICW-16		15		°C/W
θ _{JC_SOICW}	Junction-to-Case Thermal Resistance, SOICW-16		10		°C/W

Electrical Specifications

General Parameters

Unless otherwise specified: $V_{CC} = 4.75\text{ V to }5.50\text{ V}$, $T_A = -40^\circ\text{C to }+125^\circ\text{C}$, $C_{BYP} = 1.0\ \mu\text{F}$. Typical values are $V_{CC} = 5.00\text{ V}$ and $T_A = +25^\circ\text{C}$.

Symbol	Parameter	Conditions	Min.	Typ.	Max.	Unit
Power Supplies						
I_{CC}	Supply Current	$f_{BW} = 1\text{ MHz}$ No load, $I_P = 0\text{ A}$		6.0	9.0	mA
I_{OUT}	OUT Maximum Drive Capability ⁽¹⁾	OUT covers 10% to 90% of V_{CC} span.	-1.0		+1.0	mA
C_{L_OUT}	OUT Capacitive Load ⁽¹⁾				100	pF
R_{L_OUT}	OUT Resistive Load ⁽¹⁾			100		k Ω
R_{IP}	Primary Conductor Resistance ⁽¹⁾			0.5		m Ω
PSRR	Power Supply Rejection Ratio ⁽¹⁾			35		dB
SPSRR	Sensitivity Power Supply Rejection Ratio ⁽¹⁾			35		dB
OPSRR	Offset Power Supply Rejection Ratio ⁽¹⁾			40		dB
Analog Output (OUT)						
V_{OUT}	OUT Voltage Linear Range	$V_{SIG_AC} = \pm 2.00\text{ V}$ $V_{SIG_DC} = +4.00\text{ V}$	0.50		4.50	V
V_{OUT_SAT}	Output High Saturation Voltage	V_{OUT} , $T_A = +25^\circ\text{C}$,	$V_{CC} - 0.30$	$V_{CC} - 0.25$		V
CMFRR	Common Mode Field Rejection Ratio ⁽¹⁾			-54		dB
				0.5		mA/G
Timings						
t_{ON}	Power-On Time ⁽¹⁾	$V_{CC} \geq 2.50\text{ V}$		100	200	μs
t_{RISE}	Rise Time ⁽¹⁾	$I_P = I_{RANGE(MAX)}$, $T_A = +25^\circ\text{C}$, $C_L = 100\text{ pF}$		200		ns
$t_{RESPONSE}$	Response Time ⁽¹⁾			300		ns
t_{DELAY}	Propagation Delay ⁽¹⁾			250		ns
Protection						
V_{UVLO}	Under-Voltage Lockout	Rising V_{CC}		2.50		V
		Falling V_{CC}		2.45		V
V_{UV_HYS}	UVLO Hysteresis			50		mV

(1) Guaranteed by design and/or characterization; not tested in production.

Electrical Characteristics

$V_{CC} = 5.00\text{ V}$ and $T_A = +25^\circ\text{C}$ and $C_{BYP} = 1.0\ \mu\text{F}$ (unless otherwise specified)

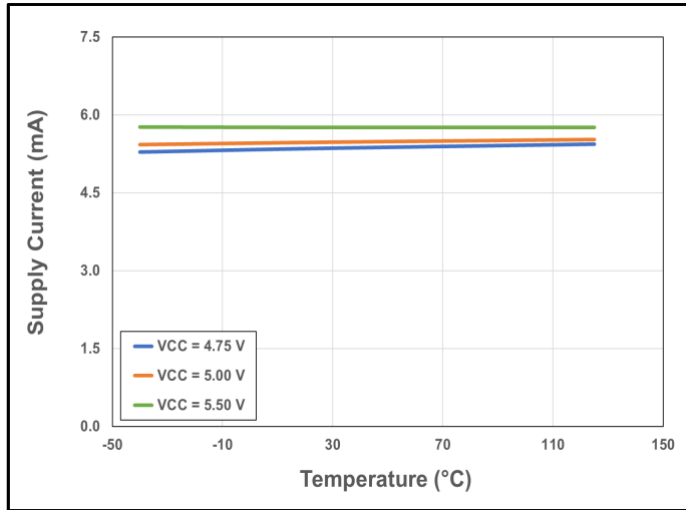

Figure 3. CT432 Supply Current vs. Temperature vs. Supply Voltage

Electrical Characteristics (continued)

$V_{CC} = 5.00\text{ V}$ and $T_A = +25^\circ\text{C}$ and $C_{BYP} = 1.0\ \mu\text{F}$ (unless otherwise specified)

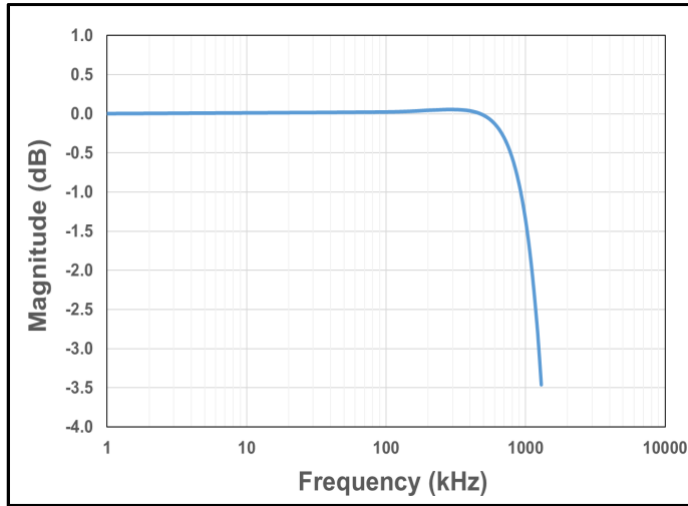

Figure 4. CT432 Bandwidth

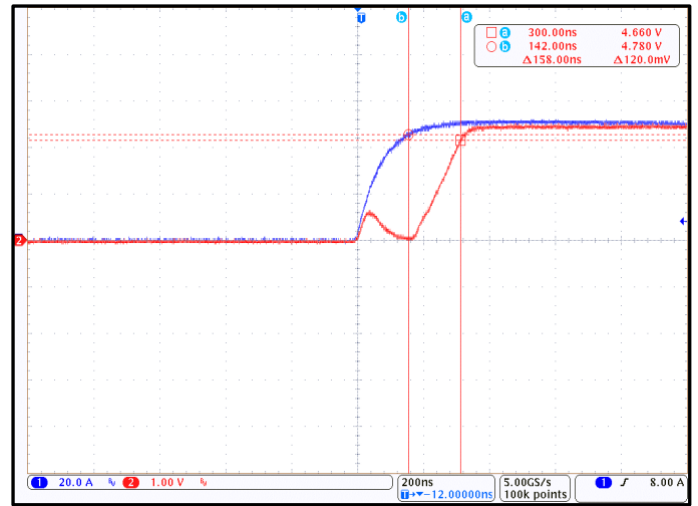

Figure 5. CT432 Response Time; $I_P = 50\text{ A}_{PK}$ and $C_L = 100\text{ pF}$ (Blue = I_{CC} , Red = V_{OUT})

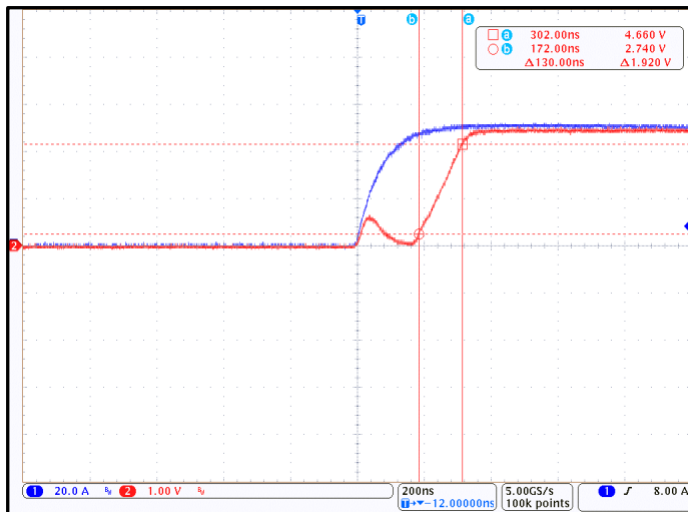

Figure 6. CT432 Rise Time; $I_P = 50\text{ A}_{PK}$ and $C_L = 100\text{ pF}$ (Blue = I_{CC} , Red = V_{OUT})

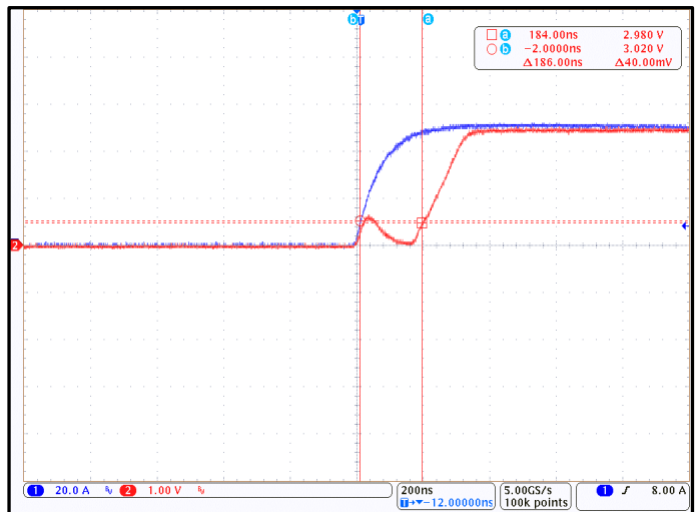

Figure 7. CT432 Propagation Delay; $I_P = 50\text{ A}_{PK}$ and $C_L = 100\text{ pF}$ (Blue = I_{CC} , Red = V_{OUT})

CT432-xSWF20DR: 0 A to +20 A

Unless otherwise specified: $V_{CC} = 4.75\text{ V to }5.50\text{ V}$, $T_A = -40^\circ\text{C to }+125^\circ\text{C}$, $C_{BYP} = 1.0\ \mu\text{F}$. Typical values are $V_{CC} = 5.00\text{ V}$ and $T_A = +25^\circ\text{C}$.

Symbol	Parameter	Conditions	Min.	Typ.	Max.	Unit
I_{RANGE}	Current Range		0		+20	A
V_{OQ}	Voltage Output Quiescent	$T_A = +25^\circ\text{C}$, $I_P = 0\text{ A}$	0.495	0.500	0.505	V
S	Sensitivity	$I_{\text{RANGE(MIN)}} \leq I_P \leq I_{\text{RANGE(MAX)}}$		200		mV/A
f_{BW}	Bandwidth ⁽¹⁾	Small Signal = -3 dB		1.0		MHz
e_{N}	Noise ⁽¹⁾	$T_A = +25^\circ\text{C}$, $f_{\text{BW}} = 100\text{ kHz}$		9.0		mA _{RMS}
OUT Accuracy Performance						
E_{OUT}	Total Output Error	$I_P = I_{\text{P(MAX)}}$		±0.7	±1.0	% FS
E_{LIN}	Non-Linearity Error ⁽¹⁾	$I_P = I_{\text{P(MAX)}}$, $T_A = -40^\circ\text{C to }+125^\circ\text{C}$		±0.1		% FS
E_{SENS}	Sensitivity Error ⁽¹⁾	$I_P = I_{\text{P(MAX)}}$, $T_A = -40^\circ\text{C to }+125^\circ\text{C}$		±0.7		% FS
V_{OFFSET}	Offset Voltage ⁽¹⁾	$I_P = 0\text{ A}$, $T_A = -40^\circ\text{C to }+125^\circ\text{C}$		±12.5		mV
				±0.3		% FS
Lifetime Drift						
$E_{\text{TOT_DRIFT}}$	Total Output Error Lifetime Drift ⁽¹⁾	$I_P = I_{\text{P(MAX)}}$		±1.0		% FS

(1) Guaranteed by design and characterization; not tested in production.

Electrical Characteristics for CT432-xSWF20DR

$V_{CC} = 5.00\text{ V}$ and $T_A = +25^\circ\text{C}$ and $C_{BYP} = 1.0\ \mu\text{F}$ (unless otherwise specified)

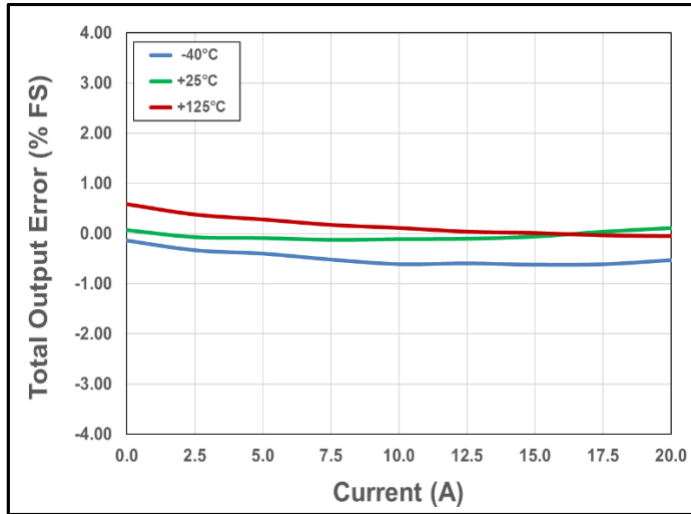

Figure 8. Total Output Error vs. Current vs. Temperature

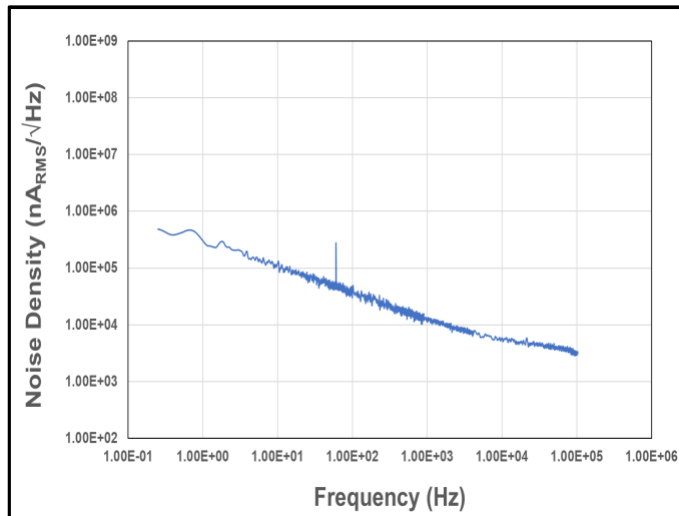

Figure 9. Noise Density vs. Frequency

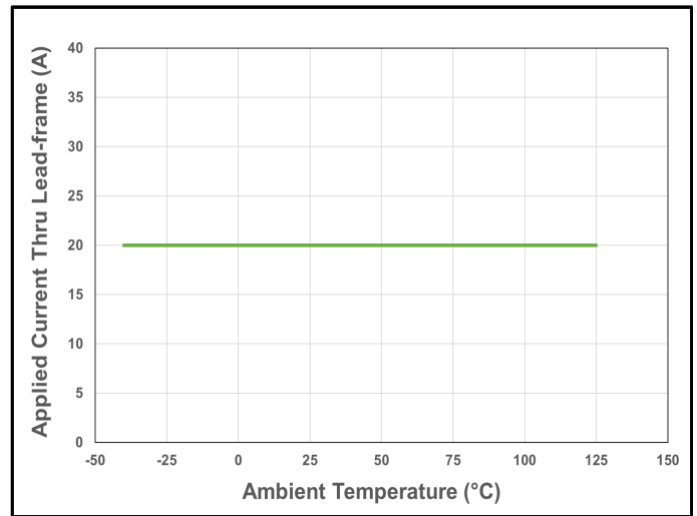

Figure 10. CT432 Current De-rating Curve for 20 A_{DC}

CT432-xSWF20MR: -20 A to +20 A

Unless otherwise specified: $V_{CC} = 4.75\text{ V to }5.50\text{ V}$, $T_A = -40^\circ\text{C to }+125^\circ\text{C}$, $C_{BYP} = 1.0\ \mu\text{F}$. Typical values are $V_{CC} = 5.00\text{ V}$ and $T_A = +25^\circ\text{C}$.

Symbol	Parameter	Conditions	Min.	Typ.	Max.	Unit
I_{RANGE}	Current Range		-20		+20	A
V_{OQ}	Voltage Output Quiescent	$T_A = +25^\circ\text{C}$, $I_P = 0\text{ A}$	2.495	2.500	2.505	V
S	Sensitivity	$I_{\text{RANGE(MIN)}} \leq I_P \leq I_{\text{RANGE(MAX)}}$		100		mV/A
f_{BW}	Bandwidth ⁽¹⁾	Small Signal = -3 dB		1.0		MHz
e_{N}	Noise ⁽¹⁾	$T_A = +25^\circ\text{C}$, $f_{\text{BW}} = 100\text{ kHz}$		10.0		mA _{RMS}
OUT Accuracy Performance						
E_{OUT}	Total Output Error	$I_P = I_{\text{P(MAX)}}$		± 0.5	± 1.0	% FS
E_{LIN}	Non-Linearity Error ⁽¹⁾	$I_P = I_{\text{P(MAX)}}$, $T_A = -40^\circ\text{C to }+125^\circ\text{C}$		± 0.1		% FS
E_{SENS}	Sensitivity Error ⁽¹⁾	$I_P = I_{\text{P(MAX)}}$, $T_A = -40^\circ\text{C to }+125^\circ\text{C}$		± 0.5		% FS
V_{OFFSET}	Offset Voltage ⁽¹⁾	$I_P = 0\text{ A}$, $T_A = -40^\circ\text{C to }+125^\circ\text{C}$		± 7.0		mV
				± 0.2		% FS
Lifetime Drift						
$E_{\text{TOT_DRIFT}}$	Total Output Error Lifetime Drift ⁽¹⁾	$I_P = I_{\text{P(MAX)}}$		± 1.0		% FS

(1) Guaranteed by design and characterization; not tested in production.

Electrical Characteristics for CT432-xSWF20MR

$V_{CC} = 5.00\text{ V}$ and $T_A = +25^\circ\text{C}$ and $C_{BYP} = 1.0\ \mu\text{F}$ (unless otherwise specified)

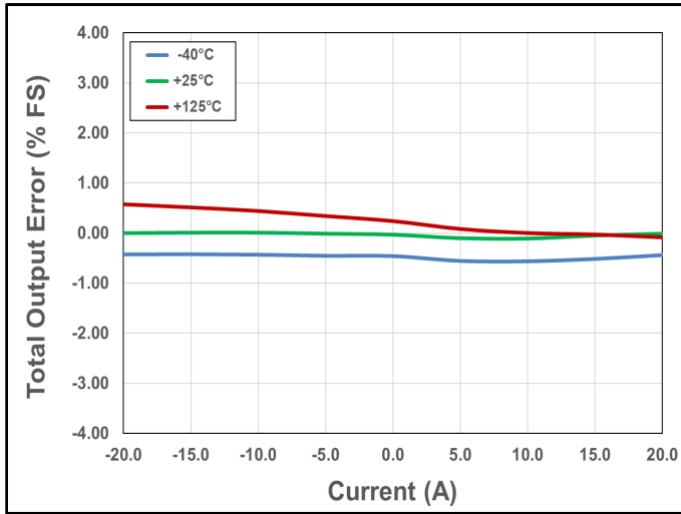

Figure 11. Total Output Error vs. Current vs. Temperature

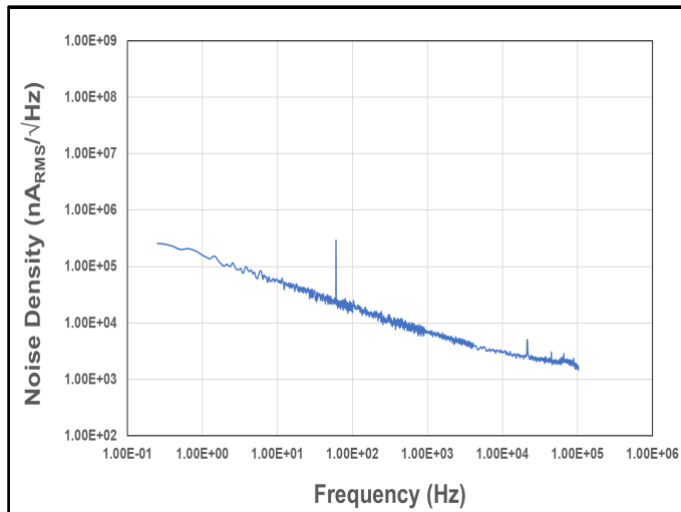

Figure 12. Noise Density vs. Frequency

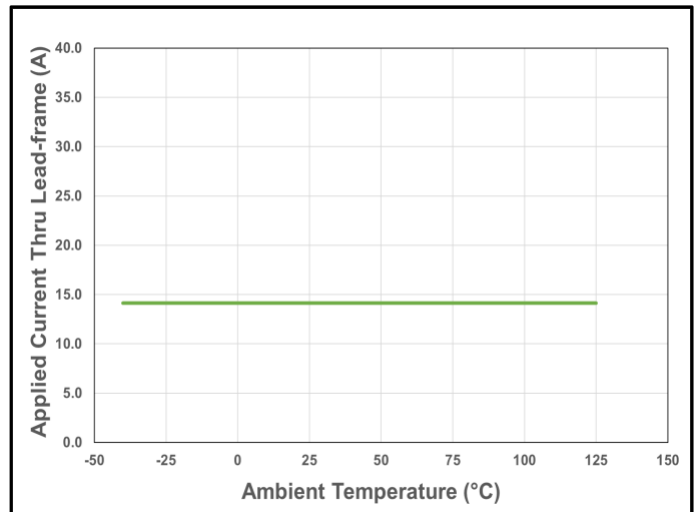

Figure 13. CT432 Current De-rating Curve for 20 A_{PK} (14.1 A_{RMS})

CT432-xSWF30DR: 0 A to +30 A

Unless otherwise specified: $V_{CC} = 4.75\text{ V to }5.50\text{ V}$, $T_A = -40^\circ\text{C to }+125^\circ\text{C}$, $C_{BYP} = 1.0\ \mu\text{F}$. Typical values are $V_{CC} = 5.00\text{ V}$ and $T_A = +25^\circ\text{C}$.

Symbol	Parameter	Conditions	Min.	Typ.	Max.	Unit
I_{RANGE}	Current Range		0		+30	A
V_{OQ}	Voltage Output Quiescent	$T_A = +25^\circ\text{C}$, $I_P = 0\text{ A}$	0.495	0.500	0.505	V
S	Sensitivity	$I_{\text{RANGE(MIN)}} \leq I_P \leq I_{\text{RANGE(MAX)}}$		133.3		mV/A
f_{BW}	Bandwidth ⁽¹⁾	Small Signal = -3 dB		1.0		MHz
e_{N}	Noise ⁽¹⁾	$T_A = +25^\circ\text{C}$, $f_{\text{BW}} = 100\text{ kHz}$		10.0		mA _{RMS}
OUT Accuracy Performance						
E_{OUT}	Total Output Error	$I_P = I_{\text{P(MAX)}}$		±0.7	±1.0	% FS
E_{LIN}	Non-Linearity Error ⁽¹⁾	$I_P = I_{\text{P(MAX)}}$, $T_A = -40^\circ\text{C to }+125^\circ\text{C}$		±0.1		% FS
E_{SENS}	Sensitivity Error ⁽¹⁾	$I_P = I_{\text{P(MAX)}}$, $T_A = -40^\circ\text{C to }+125^\circ\text{C}$		±0.6		% FS
V_{OFFSET}	Offset Voltage ⁽¹⁾	$I_P = 0\text{ A}$, $T_A = -40^\circ\text{C to }+125^\circ\text{C}$		±13.5		mV
				±0.3		% FS
Lifetime Drift						
$E_{\text{TOT_DRIFT}}$	Total Output Error Lifetime Drift ⁽¹⁾	$I_P = I_{\text{P(MAX)}}$		±1.0		% FS

(1) Guaranteed by design and characterization; not tested in production.

Electrical Characteristics for CT432-xSWF30DR

$V_{CC} = 5.00\text{ V}$ and $T_A = +25^\circ\text{C}$ and $C_{BYP} = 1.0\ \mu\text{F}$ (unless otherwise specified)

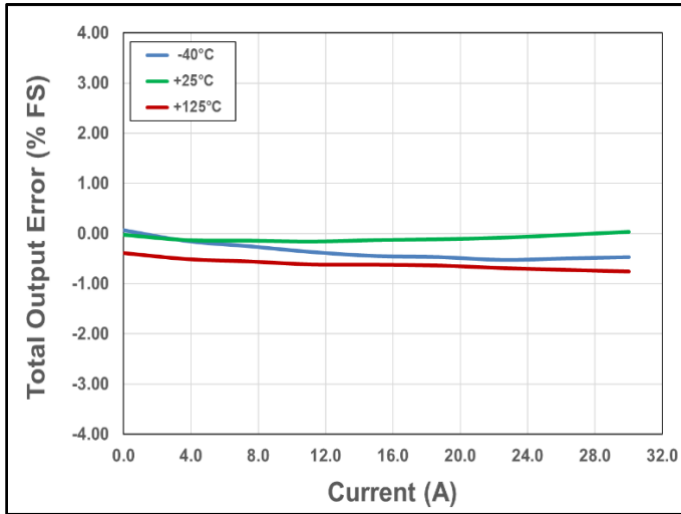

Figure 14. Total Output Error vs. Current vs. Temperature

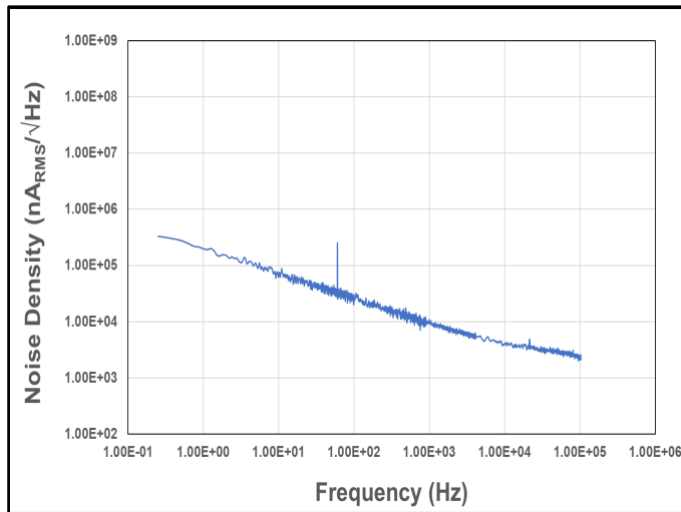

Figure 15. Noise Density vs. Frequency

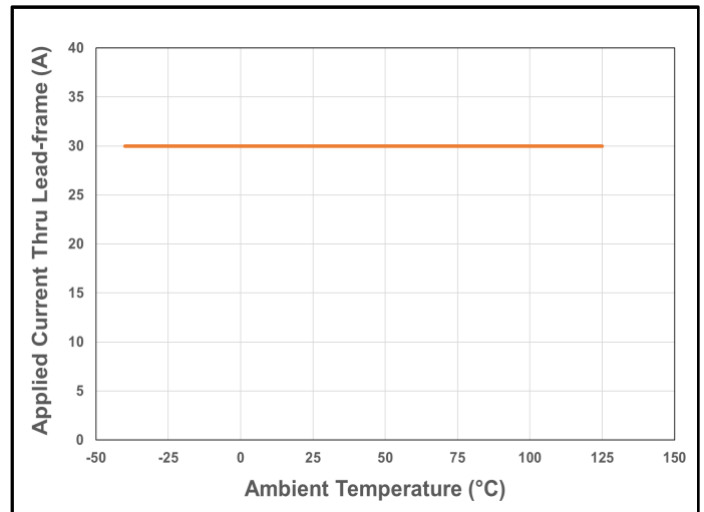

Figure 16. CT432 Current De-rating Curve for 30 A_{DC}

CT432-xSWF30MR: -30 A to +30 A

Unless otherwise specified: $V_{CC} = 4.75\text{ V to }5.50\text{ V}$, $T_A = -40^\circ\text{C to }+125^\circ\text{C}$, $C_{BYP} = 1.0\ \mu\text{F}$. Typical values are $V_{CC} = 5.00\text{ V}$ and $T_A = +25^\circ\text{C}$.

Symbol	Parameter	Conditions	Min.	Typ.	Max.	Unit
I_{RANGE}	Current Range		-30		+30	A
V_{OQ}	Voltage Output Quiescent	$T_A = +25^\circ\text{C}$, $I_P = 0\text{ A}$	2.495	2.500	2.505	V
S	Sensitivity	$I_{\text{RANGE(MIN)}} \leq I_P \leq I_{\text{RANGE(MAX)}}$		66.7		mV/A
f_{BW}	Bandwidth ⁽¹⁾	Small Signal = -3 dB		1.0		MHz
e_{N}	Noise ⁽¹⁾	$T_A = +25^\circ\text{C}$, $f_{\text{BW}} = 100\text{ kHz}$		11.5		mA _{RMS}
OUT Accuracy Performance						
E_{OUT}	Total Output Error	$I_P = I_{\text{P(MAX)}}$		±0.5	±1.0	% FS
E_{LIN}	Non-Linearity Error ⁽¹⁾	$I_P = I_{\text{P(MAX)}}$, $T_A = -40^\circ\text{C to }+125^\circ\text{C}$		±0.1		% FS
E_{SENS}	Sensitivity Error ⁽¹⁾	$I_P = I_{\text{P(MAX)}}$, $T_A = -40^\circ\text{C to }+125^\circ\text{C}$		±0.4		% FS
V_{OFFSET}	Offset Voltage ⁽¹⁾	$I_P = 0\text{ A}$, $T_A = -40^\circ\text{C to }+125^\circ\text{C}$		±9.0		mV
				±0.2		% FS
Lifetime Drift						
$E_{\text{TOT_DRIFT}}$	Total Output Error Lifetime Drift ⁽¹⁾	$I_P = I_{\text{P(MAX)}}$		±1.0		% FS

(1) Guaranteed by design and characterization; not tested in production.

Electrical Characteristics for CT432-xSWF30MR

$V_{CC} = 5.00\text{ V}$ and $T_A = +25^\circ\text{C}$ and $C_{BYP} = 1.0\ \mu\text{F}$ (unless otherwise specified)

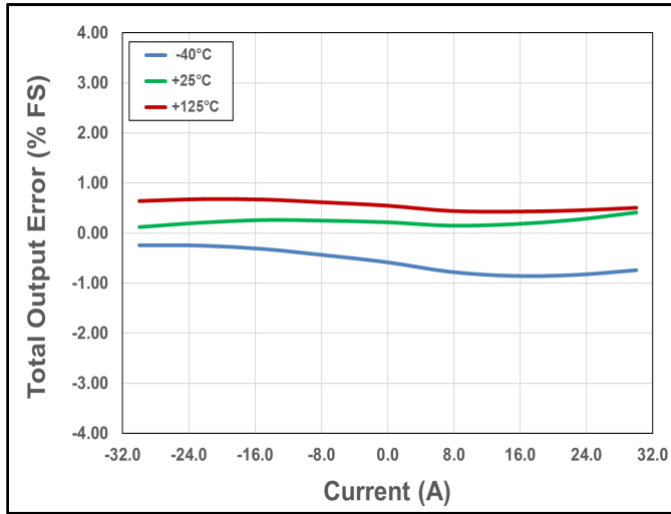

Figure 17. Total Output Error vs. Current vs. Temperature

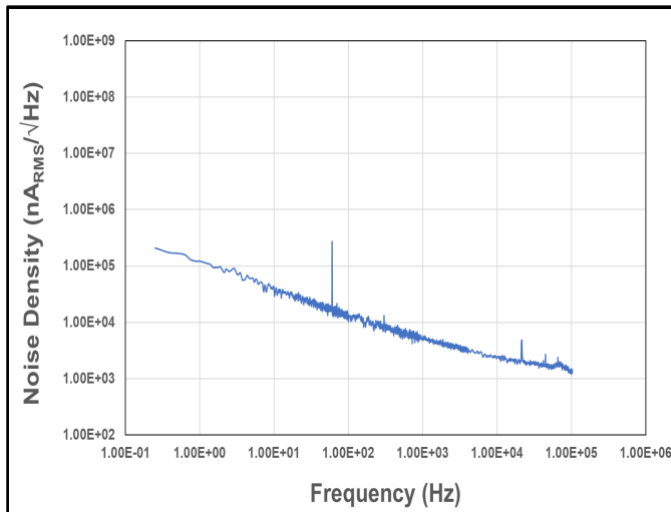

Figure 18. Noise Density vs. Frequency

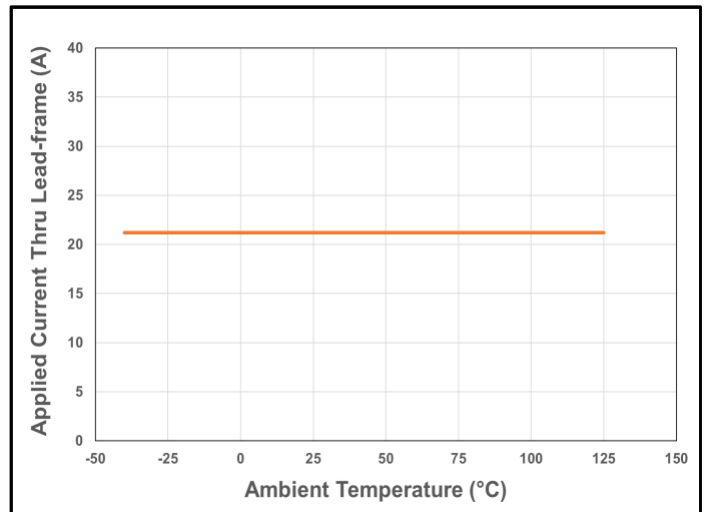

Figure 19. CT432 Current De-rating Curve for 30 A_{PK} (21.2 A_{RMS})

CT432-xSWF50DR: 0 A to +50 A

Unless otherwise specified: $V_{CC} = 4.75\text{ V to }5.50\text{ V}$, $T_A = -40^\circ\text{C to }+125^\circ\text{C}$, $C_{BYP} = 1.0\ \mu\text{F}$. Typical values are $V_{CC} = 5.00\text{ V}$ and $T_A = +25^\circ\text{C}$.

Symbol	Parameter	Conditions	Min.	Typ.	Max.	Unit
I_{RANGE}	Current Range		0		+50	A
V_{OQ}	Voltage Output Quiescent	$T_A = +25^\circ\text{C}$, $I_P = 0\text{ A}$	0.495	0.500	0.505	V
S	Sensitivity	$I_{\text{RANGE(MIN)}} \leq I_P \leq I_{\text{RANGE(MAX)}}$		80		mV/A
f_{BW}	Bandwidth ⁽¹⁾	Small Signal = -3 dB		1.0		MHz
e_{N}	Noise ⁽¹⁾	$T_A = +25^\circ\text{C}$, $f_{\text{BW}} = 100\text{ kHz}$		10.0		mA _{RMS}
OUT Accuracy Performance						
E_{OUT}	Total Output Error	$I_P = I_{\text{P(MAX)}}$		± 0.7	± 1.5	% FS
E_{LIN}	Non-Linearity Error ⁽¹⁾	$I_P = I_{\text{P(MAX)}}$, $T_A = -40^\circ\text{C to }+125^\circ\text{C}$		± 0.2		% FS
E_{SENS}	Sensitivity Error ⁽¹⁾	$I_P = I_{\text{P(MAX)}}$, $T_A = -40^\circ\text{C to }+125^\circ\text{C}$		± 0.6		% FS
V_{OFFSET}	Offset Voltage ⁽¹⁾	$I_P = 0\text{ A}$, $T_A = -40^\circ\text{C to }+125^\circ\text{C}$		± 12.9		mV
				± 0.3		% FS
Lifetime Drift						
$E_{\text{TOT_DRIFT}}$	Total Output Error Lifetime Drift ⁽¹⁾	$I_P = I_{\text{P(MAX)}}$		± 1.0		% FS

(1) Guaranteed by design and characterization; not tested in production.

Electrical Characteristics for CT432-xSWF50DR

$V_{CC} = 5.00\text{ V}$ and $T_A = +25^\circ\text{C}$ and $C_{BYP} = 1.0\ \mu\text{F}$ (unless otherwise specified)

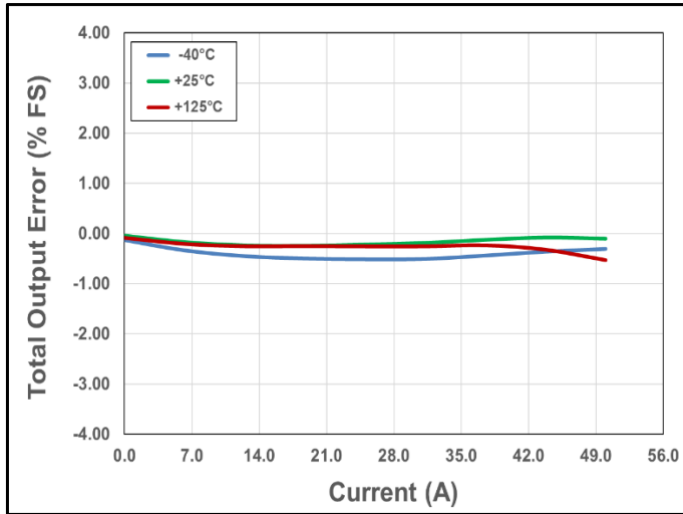

Figure 20. Total Output Error vs. Current vs. Temperature

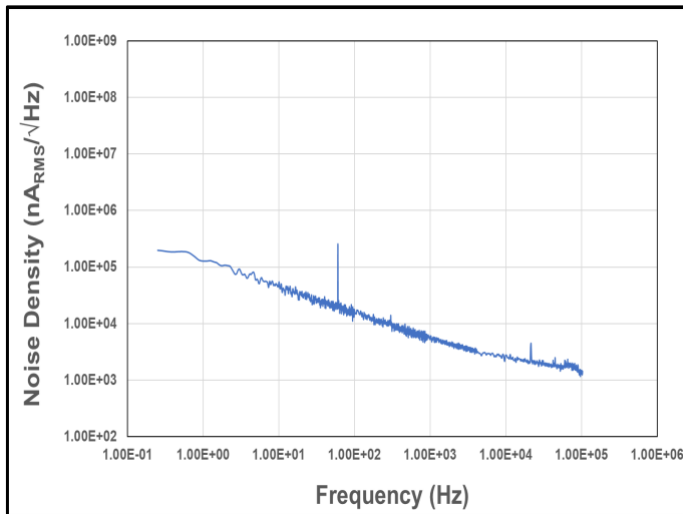

Figure 21. Noise Density vs. Frequency

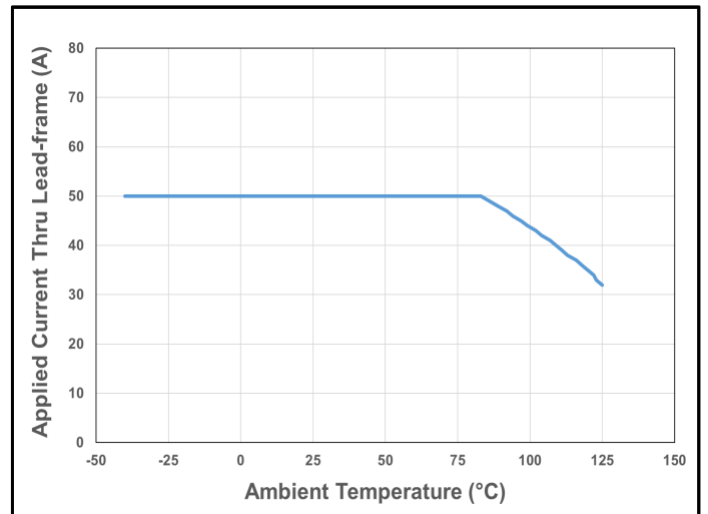

Figure 22. CT432 Current De-rating Curve for 50 A_{DC}

CT432-xSWF50MR: -50 A to +50 A

Unless otherwise specified: $V_{CC} = 4.75\text{ V to }5.50\text{ V}$, $T_A = -40^\circ\text{C to }+125^\circ\text{C}$, $C_{BYP} = 1.0\ \mu\text{F}$. Typical values are $V_{CC} = 5.00\text{ V}$ and $T_A = +25^\circ\text{C}$.

Symbol	Parameter	Conditions	Min.	Typ.	Max.	Unit
I_{RANGE}	Current Range		-50		+50	A
V_{OQ}	Voltage Output Quiescent	$T_A = +25^\circ\text{C}$, $I_P = 0\text{ A}$	2.495	2.500	2.505	V
S	Sensitivity	$I_{\text{RANGE(MIN)}} \leq I_P \leq I_{\text{RANGE(MAX)}}$		40		mV/A
f_{BW}	Bandwidth ⁽¹⁾	Small Signal = -3 dB		1.0		MHz
e_{N}	Noise ⁽¹⁾	$T_A = +25^\circ\text{C}$, $f_{\text{BW}} = 100\text{ kHz}$		14.0		mA _{RMS}
OUT Accuracy Performance						
E_{OUT}	Total Output Error	$I_P = I_{\text{P(MAX)}}$		± 0.5	± 1.0	% FS
E_{LIN}	Non-Linearity Error ⁽¹⁾	$I_P = I_{\text{P(MAX)}}$, $T_A = -40^\circ\text{C to }+125^\circ\text{C}$		± 0.1		% FS
E_{SENS}	Sensitivity Error ⁽¹⁾	$I_P = I_{\text{P(MAX)}}$, $T_A = -40^\circ\text{C to }+125^\circ\text{C}$		± 0.5		% FS
V_{OFFSET}	Offset Voltage ⁽¹⁾	$I_P = 0\text{ A}$, $T_A = -40^\circ\text{C to }+125^\circ\text{C}$		± 10.9		mV
				± 0.3		% FS
Lifetime Drift						
$E_{\text{TOT_DRIFT}}$	Total Output Error Lifetime Drift ⁽¹⁾	$I_P = I_{\text{P(MAX)}}$		± 1.0		% FS

(1) Guaranteed by design and characterization; not tested in production.

Electrical Characteristics for CT432-xSWF50MR

$V_{CC} = 5.00\text{ V}$ and $T_A = +25^\circ\text{C}$ and $C_{BYP} = 1.0\ \mu\text{F}$ (unless otherwise specified)

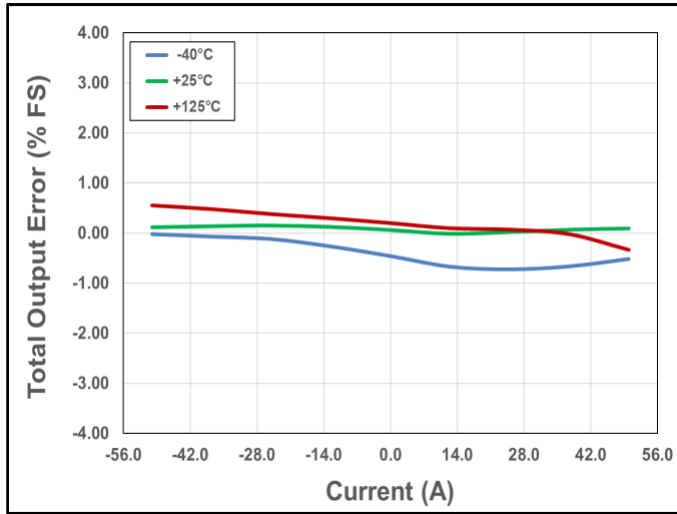

Figure 23. Total Output Error vs. Current vs. Temperature

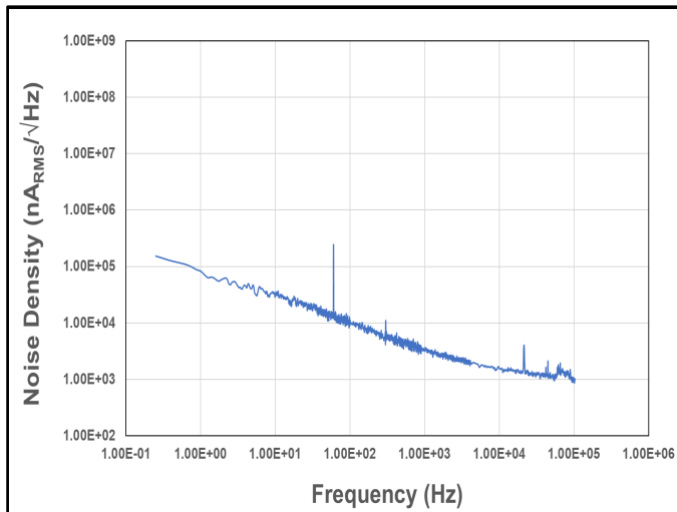

Figure 24. Noise Density vs. Frequency

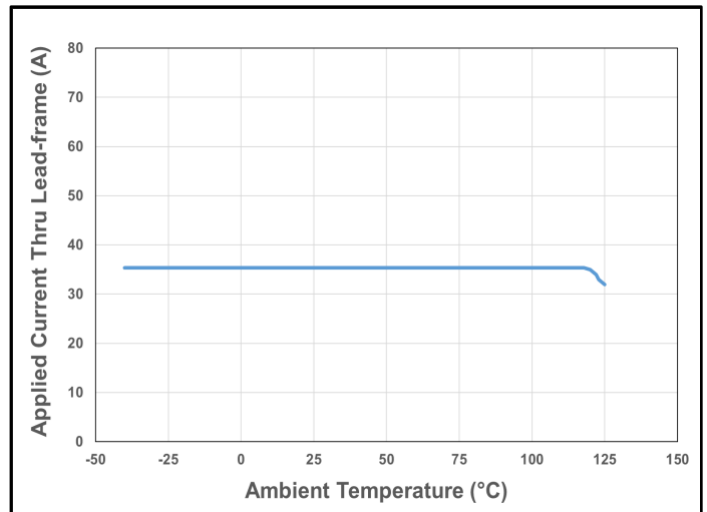

Figure 25. CT432 Current De-rating Curve for 50 A_{PK} (35.5 A_{RMS})

CT432-xSWF65DR: 0 A to +65 A

Unless otherwise specified: $V_{CC} = 4.75\text{ V to }5.50\text{ V}$, $T_A = -40^\circ\text{C to }+125^\circ\text{C}$, $C_{BYP} = 1.0\ \mu\text{F}$. Typical values are $V_{CC} = 5.00\text{ V}$ and $T_A = +25^\circ\text{C}$.

Symbol	Parameter	Conditions	Min.	Typ.	Max.	Unit
I_{RANGE}	Current Range		0		+65	A
V_{OQ}	Voltage Output Quiescent	$T_A = +25^\circ\text{C}$, $I_P = 0\text{ A}$	0.495	0.500	0.505	V
S	Sensitivity	$I_{\text{RANGE(MIN)}} \leq I_P \leq I_{\text{RANGE(MAX)}}$		61.5		mV/A
f_{BW}	Bandwidth ⁽¹⁾	Small Signal = -3 dB		1.0		MHz
e_{N}	Noise ⁽¹⁾	$T_A = +25^\circ\text{C}$, $f_{\text{BW}} = 100\text{ kHz}$		10.0		mA _{RMS}
$t_{\text{IP(MAX)}}$	Maximum Time @ $I_{\text{P(MAX)}}$ (1)					s
OUT Accuracy Performance						
E_{OUT}	Total Output Error	$I_P = I_{\text{P(MAX)}}$		± 0.7	± 1.5	% FS
E_{LIN}	Non-Linearity Error ⁽¹⁾	$I_P = I_{\text{P(MAX)}}$, $T_A = -40^\circ\text{C to }+125^\circ\text{C}$		± 0.2		% FS
E_{SENS}	Sensitivity Error ⁽¹⁾	$I_P = I_{\text{P(MAX)}}$, $T_A = -40^\circ\text{C to }+125^\circ\text{C}$		± 0.4		% FS
V_{OFFSET}	Offset Voltage ⁽¹⁾	$I_P = 0\text{ A}$, $T_A = -40^\circ\text{C to }+125^\circ\text{C}$		± 3.0		mV
				± 0.1		% FS
Lifetime Drift						
$E_{\text{TOT_DRIFT}}$	Total Output Error Lifetime Drift ⁽¹⁾	$I_P = I_{\text{P(MAX)}}$		± 1.0		% FS

(2) Guaranteed by design and characterization; not tested in production.

Electrical Characteristics for CT432-xSWF65DR

$V_{CC} = 5.00\text{ V}$ and $T_A = +25^\circ\text{C}$ and $C_{BYP} = 1.0\ \mu\text{F}$ (unless otherwise specified)

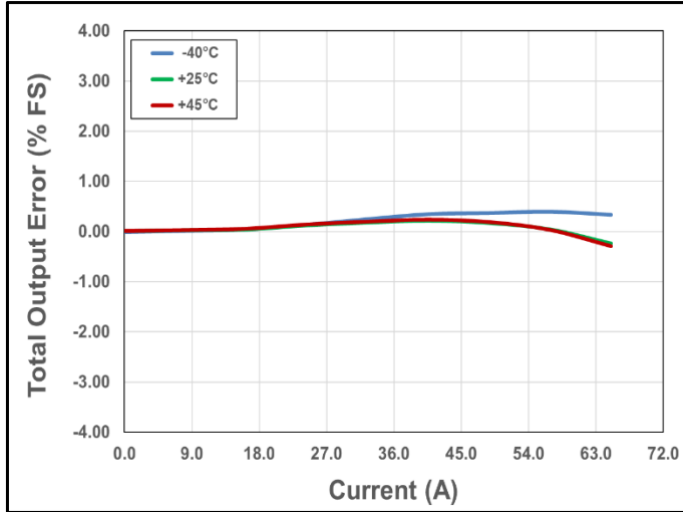

Figure 26. Total Output Error vs. Current vs. Temperature

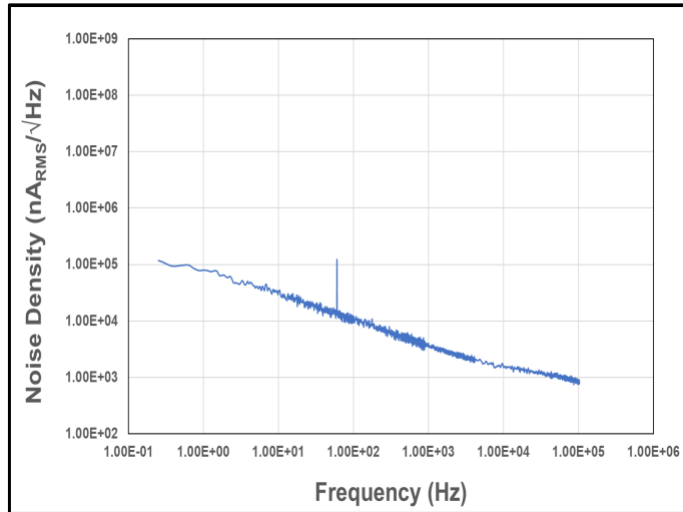

Figure 27. Noise Density vs. Frequency

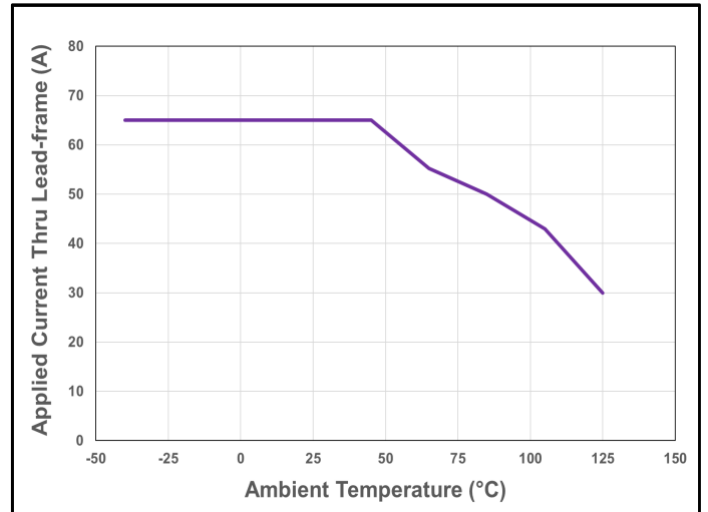

Figure 28. CT432 Current De-rating Curve for 65 A_{DC}

CT432-xSWF65MR: -65 A to +65 A

Unless otherwise specified: $V_{CC} = 4.75\text{ V to }5.50\text{ V}$, $T_A = -40^\circ\text{C to }+125^\circ\text{C}$, $C_{BYP} = 1.0\ \mu\text{F}$. Typical values are $V_{CC} = 5.00\text{ V}$ and $T_A = +25^\circ\text{C}$.

Symbol	Parameter	Conditions	Min.	Typ.	Max.	Unit
I_{RANGE}	Current Range		-65		+65	A
V_{OQ}	Voltage Output Quiescent	$T_A = +25^\circ\text{C}$, $I_P = 0\text{ A}$	2.495	2.500	2.505	V
S	Sensitivity	$I_{\text{RANGE(MIN)}} \leq I_P \leq I_{\text{RANGE(MAX)}}$		30.8		mV/A
f_{BW}	Bandwidth ⁽¹⁾	Small Signal = -3 dB		1.0		MHz
e_{N}	Noise ⁽¹⁾	$T_A = +25^\circ\text{C}$, $f_{\text{BW}} = 100\text{ kHz}$		13.5		mA _{RMS}
OUT Accuracy Performance						
E_{OUT}	Total Output Error	$I_P = I_{\text{P(MAX)}}$		± 0.5	± 1.0	% FS
E_{LIN}	Non-Linearity Error ⁽¹⁾	$I_P = I_{\text{P(MAX)}}$, $T_A = -40^\circ\text{C to }+125^\circ\text{C}$		± 0.2		% FS
E_{SENS}	Sensitivity Error ⁽¹⁾	$I_P = I_{\text{P(MAX)}}$, $T_A = -40^\circ\text{C to }+125^\circ\text{C}$		± 0.3		% FS
V_{OFFSET}	Offset Voltage ⁽¹⁾	$I_P = 0\text{ A}$, $T_A = -40^\circ\text{C to }+125^\circ\text{C}$		± 3.0		mV
				± 0.1		% FS
Lifetime Drift						
$E_{\text{TOT_DRIFT}}$	Total Output Error Lifetime Drift ⁽¹⁾	$I_P = I_{\text{P(MAX)}}$		± 1.0		% FS

(2) Guaranteed by design and characterization; not tested in production.

Electrical Characteristics for CT432-xSWF65MR

$V_{CC} = 5.00\text{ V}$ and $T_A = +25^\circ\text{C}$ and $C_{BYP} = 1.0\ \mu\text{F}$ (unless otherwise specified)

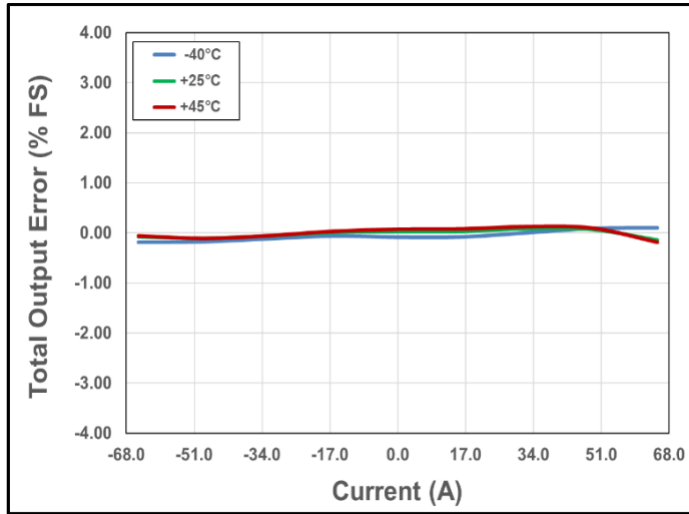

Figure 29. Total Output Error vs. Current vs. Temperature

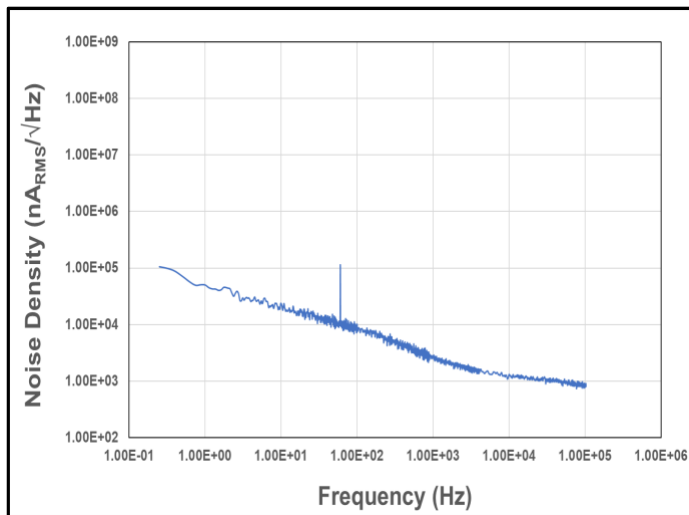

Figure 30. Noise Density vs. Frequency

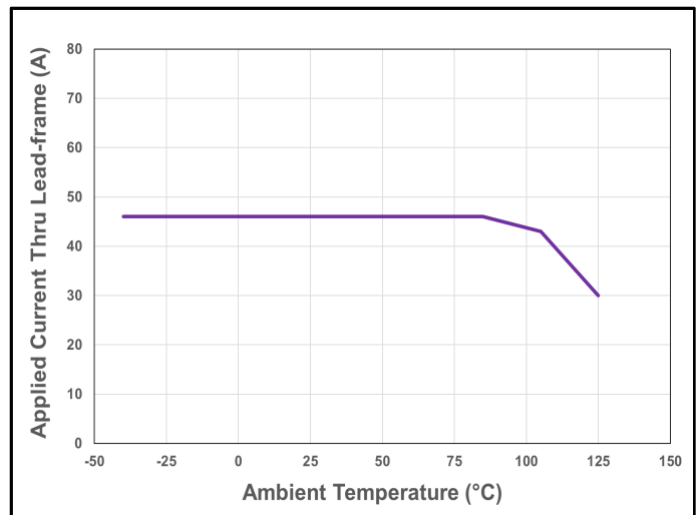

Figure 31. CT432 Current De-rating Curve for 65 A_{PK} (46.0 A_{RMS})

Circuit Description

Overview

The CT432 is a very high accuracy contact current sensor with an integrated current carrying conductor (CCC) that handles up to 65 A. It has very high sensitivity and a wide dynamic range with excellent accuracy (very low total output error) across temperature. This current sensor supports the current ranges below:

- 0 A to +20 A
- -20 A to +20 A
- 0 A to +30 A
- -30 A to +30 A
- 0 A to +50 A
- -50 A to +50 A
- 0 A to +65 A
- -65 A to +65 A

When current is flowing through the CCC, the XtremeSense TMR sensors inside the chip senses the field which in turn generates differential voltage signals that then goes through the Analog Front-End (AFE) to output a current measurement with less than ±1.0% Full-Scale (FS) total output error (E_{OUT}).

The chip is designed to enable a very fast response time of 300 ns for the current measurement from the OUT pin as the bandwidth for the CT432 is 1.0 MHz. Even with a high bandwidth, the chip consumes a minimal amount of power.

Linear Output Current Measurement

The CT432 provides a continuous linear analog output voltage which represents the current measurement. The output voltage range of OUT is from 0.50 V to 4.50 V with a V_{OQ} of 0.50 V and 2.50 V for unidirectional and bidirectional currents, respectively. Figure 32 illustrates the output voltage range of the OUT pin as a function of the measured current.

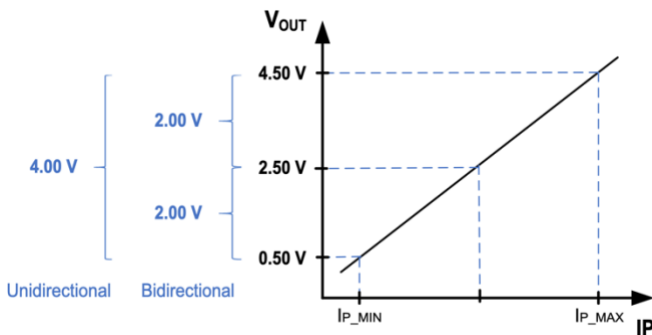

Figure 32. Linear Output Voltage Range (OUT) vs. Measured Current (IP)

Total Output Error

The Total Output Error is the difference between the current measured by CT432 and the actual current, relative to the actual current. It is equivalent to the ratio between the difference of the ideal and actual voltage to the ideal sensitivity multiplied by the current flowing through the primary conductor (CCC). The following equation defines the Total Output Error (E_{OUT}) for the CT432:

$$E_{OUT} = 100 * \frac{V_{IOUT_IDEAL}(I_P) - V_{IOUT}(I_P)}{S_{IDEAL}(I_P) \times I_P}$$

The E_{OUT} incorporates all sources of error and is a function of the sensed current (I_P) from CT432. At high current levels, the E_{OUT} will be dominated by the sensitivity error whereas at low current, the dominant characteristic is the offset voltage. Figure 33 shows the behavior of E_{OUT} versus I_P . When I_P goes to 0 from both directions, the curves exhibit asymptotic behavior (i.e., E_{OUT} approaches infinity).

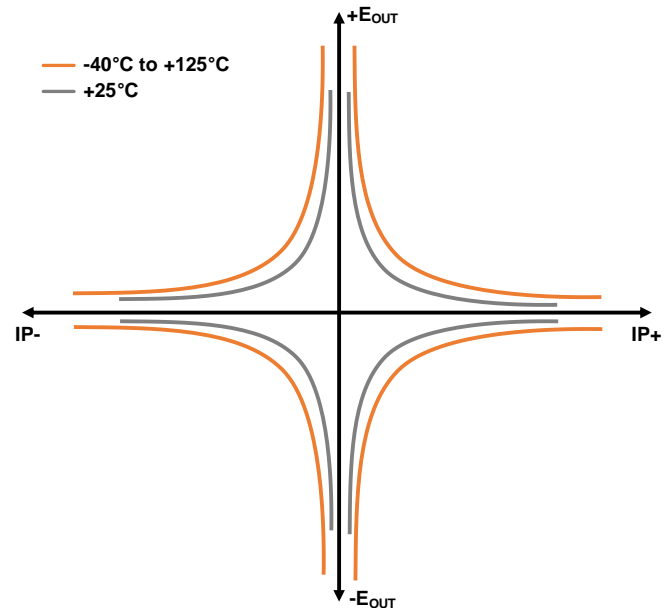

Figure 33. Total Output Error (E_{OUT}) vs. Sensed Current (I_P)

The CT432 achieves a total output error (E_{OUT}) that is less than ±1.0% of Full-Scale (FS) over supply voltage and temperature. It is designed with innovative and proprietary TMR sensors and circuit blocks to provide very accurate current measurements regardless of the operating conditions.

Sensitivity Error

The sensitivity error (E_{SENS}) is the sensitivity temperature drift error for unipolar or DC current. It is calculated using the equation below:

$$E_{SENS} = \left(\frac{S_{MEASURED}}{S} - 1 \right) \times 100$$

Power-On Time (t_{ON})

The Power-On Time (t_{ON}) of 100 μ s is the amount of time required by CT432 to start up, fully power the chip and becoming fully operational from the moment the supply voltage is greater than the UVLO voltage. This time includes the ramp up time and the settling time (within 10% of steady-state voltage) after the power supply has reached the minimum V_{CC} .

Response Time ($t_{RESPONSE}$)

The Response Time ($t_{RESPONSE}$) of 300 ns for the CT432 is the time interval between the following terms:

1. When the primary current signal reaches 90% of its final value,
2. When the chip reaches 90% of its output corresponding to the applied current.

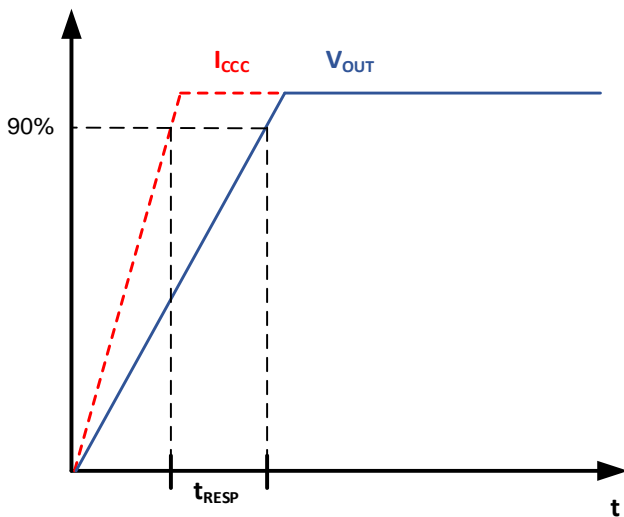

Figure 34. CT432 Response Time Curve

Rise Time (t_{RISE})

The CT432's rise time, t_{RISE} , is the time interval of when its output reaches 10% and 90% of the full-scale output voltage. The t_{RISE} of the CT432 is 200 ns.

Propagation Delay (t_{DELAY})

The Propagation Delay (t_{DELAY}) is the time difference between these two events:

1. When the primary current reaches 20% of its final value
2. When the chip reaches 20% of its output corresponding to the applied current.

The CT432 has a propagation delay of 250 ns.

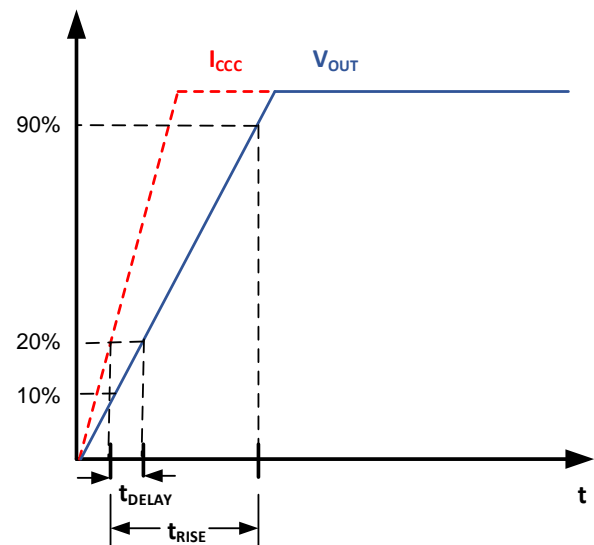

Figure 35. CT432 Propagation Delay and Rise Time Curve

Under-Voltage Lockout (UVLO)

The Under-Voltage Lock-out protection circuitry of the CT432 is activated when the supply voltage (V_{CC}) falls below 2.45 V. The CT432 remains in a low quiescent state until V_{CC} rises above the UVLO threshold (2.50 V). In this condition where the V_{CC} is less than 2.45 V and UVLO is triggered, the output from the CT432 is not valid. Once the V_{CC} rises above 2.50 V then the UVLO is cleared.

Immunity to Common Mode Fields

The CT432 is housed in custom plastic package that utilizes a “U-shaped” lead-frame to reduce the common mode fields generated by external stray magnetic fields. With the “U-shaped” lead-frame, the stray fields cancel one another thus reducing electro-magnetic interference (EMI). The CT432 is able to achieve -54 dB of Common Mode Rejection Ratio (CMFRR).

Also, good PCB layout of the CT432 will optimize performance and reduce EMI. Please see the Applications Information section in this data sheet for recommendations on PCB layout.

Creepage and Clearance

Two important terms as it relates to isolation provided by the package are creepage and clearance. Creepage is defined as the shortest distance across the surface of the package from one side of the leads to the other side of the leads. The definition for clearance is the shortest distance between the leads of the opposite side through the air. Figure 36 illustrates the creepage and clearance for the SOICW-16 package of the CT432.

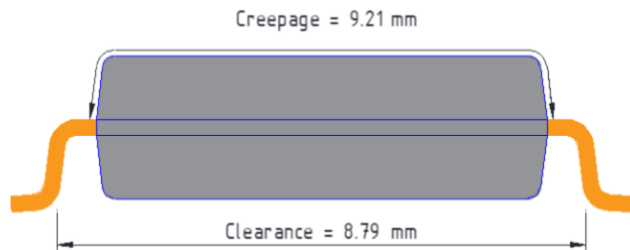

Figure 36. The Creepage and Clearance for the CT432's SOICW-16 package

Applications Information

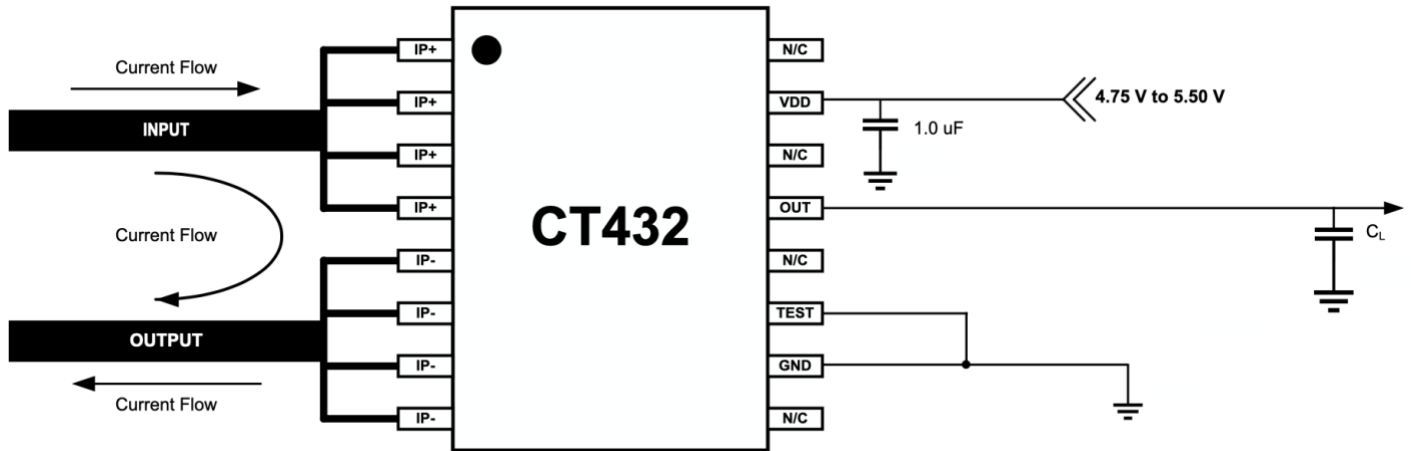

Figure 37. CT432 Application Block Diagram

Application

The CT432 is an integrated contact current sensor that can be used in many applications from measuring current in power supplies to motor control to over-current fault protection. It is a plug-and-play solution in that no calibration is required and it can outputs to a microcontroller a simple linear analog output voltage which corresponds to a current measurement value. Figure 37 is an application diagram of how CT432 would be implemented in a system

It is designed to support an operating voltage range of 4.75 V to 5.50 V, but it is ideal to use a 5.0 V power supply where the output tolerance is less than $\pm 5\%$.

Bypass Capacitor

A single 1.0 μF capacitor is needed for the VCC pin to reduce the noise from the power supply and other circuits. This capacitor should be placed as close as possible to the CT432 to minimize inductance and resistance between the two devices.

Fuse Time vs. Current

Since the CT433 is a contact current sensor, it dissipates heat as current is conducted through its lead-frame.

The CT433's lead-frame has 0.5 m Ω resistance (Typ. Value) which results in very low power dissipation during normal operation.

However, when the current surges above the rated nominal values of the CT433 due to short circuit or transient current spikes for a specific duration of time, the lead-frame will be permanently damaged.

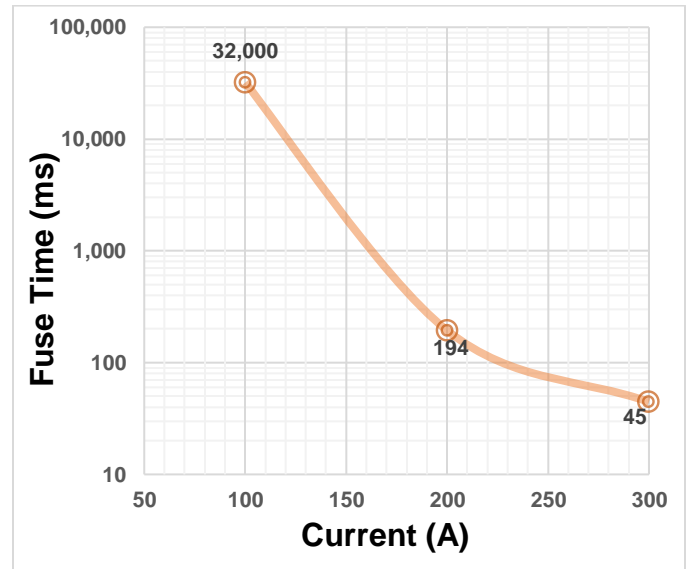

Figure 38. CT432 Fuse Time vs. Current

Figure 38 illustrates the CT432's fuse time for 100 A, 200 A, and 300 A current levels. The CT432 tolerates 100 A for 32 s while, at 200 A and 300 A, the fuse times are 194 ms and 45 ms, respectively.

SOICW-16 Package Drawing and Dimensions

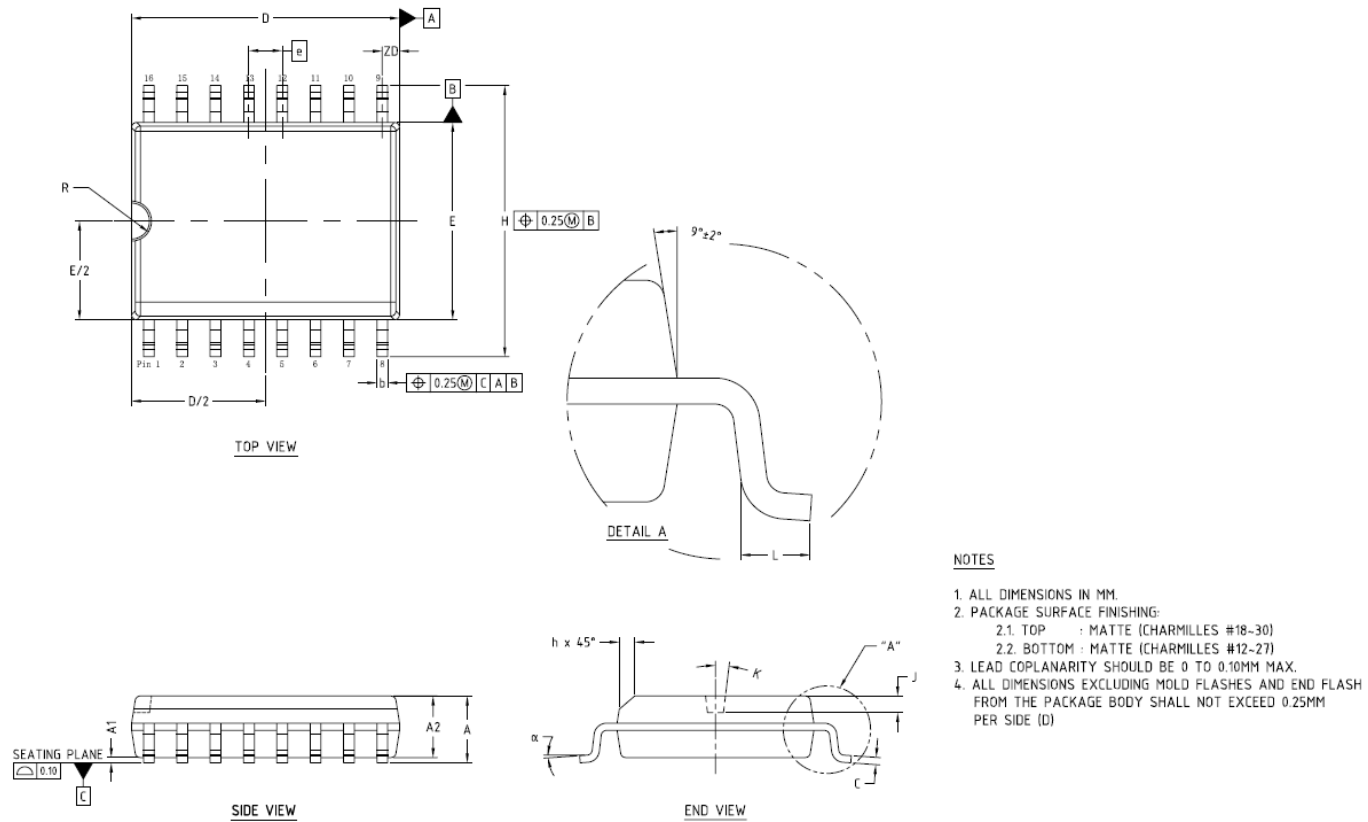

Figure 39. SOICW-16 Package Drawing

Table 1. CT432 SOICW-16 Package Dimensions

Symbol	Dimensions in Millimeters (mm)		
	Min.	Typ.	Max.
A	2.44	2.54	2.64
A1	0.10	0.20	0.30
A2	2.24	2.34	2.44
b	0.36	0.41	0.46
C	0.24	0.25	0.26
D	10.11	10.21	10.31
E	7.40	7.50	7.60
e	1.27 BSC		
H	10.11	10.31	10.51
h	0.31	0.51	0.71
J	0.53	0.63	0.73
K	7° BSC		
L	0.51	0.76	1.01
R	0.63	0.76	0.89
ZD	0.66 REF		
α	0°	-	8°

Crocus Technology provides package drawings as a service to customers considering or planning to use Crocus products in their designs. Drawings may change without notice. Please note the revision and date of the data sheet and contact a Crocus Technology representative to verify or obtain the most recent version. The package specifications do not expand the terms of Crocus Technology's worldwide terms and conditions, specifically the warranty therein, which covers Crocus Technology's products.

SOICW-16 Tape & Pocket Drawing and Dimensions

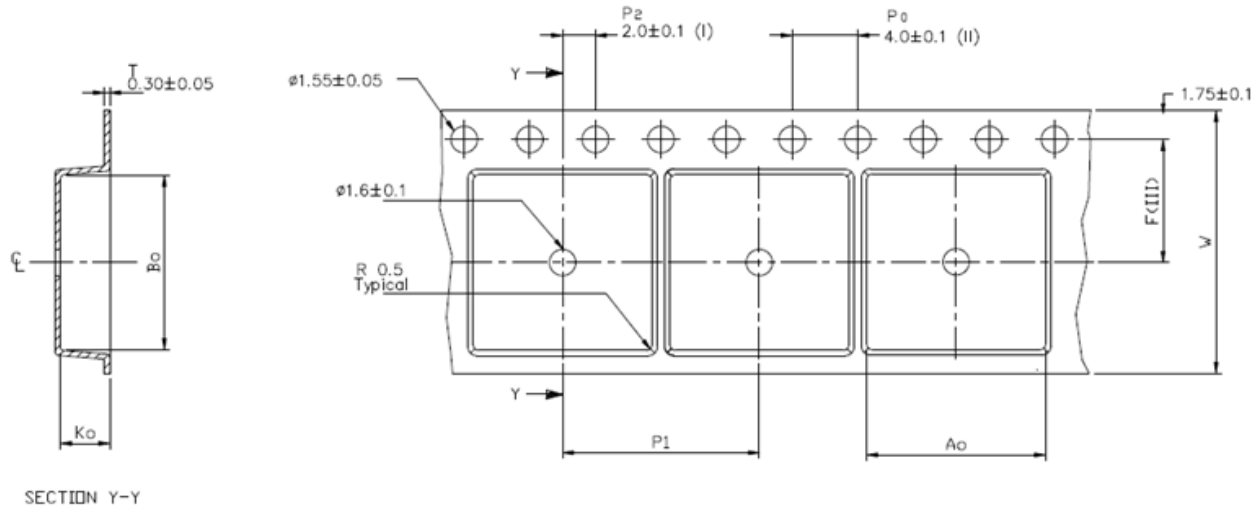

Ao	10.90 +/- 0.1
Bo	10.70 +/- 0.1
Ko	3.00 +/- 0.1
F	7.50 +/- 0.1
P1	12.00 +/- 0.1
W	16.00 +/- 0.3

- (I) Measured from centreline of sprocket hole to centreline of pocket.
- (II) Cumulative tolerance of 10 sprocket holes is ± 0.20 .
- (III) Measured from centreline of sprocket hole to centreline of pocket.
- (IV) Other material available.
- (V) Typical SR of form tape Max 10^8 OHM/SQ

ALL DIMENSIONS IN MILLIMETRES UNLESS OTHERWISE STATED.

Figure 40. SOICW-16 Package Drawing

CT432 Tape Pocket Orientation

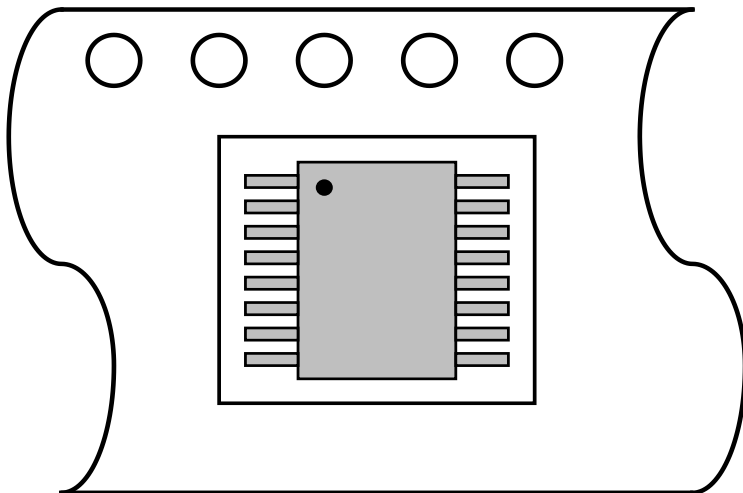

Figure 41. SOICW-16 Orientation in Tape Pocket

Package Information

Table 2. CT432 Package Information

Part Number	Package Type	# of Leads	Quantity per Reel	Lead Finish	MSL Rating ⁽²⁾	Operating Temperature ⁽³⁾	Device Marking ⁽⁴⁾
CT432-HSWF20DR	SOIC-W	16	1,000	Sn	3	-40°C to +125°C	CT432 SWF20DR YYWWLL
CT432-ASWF20DR	SOIC-W	16	1,000	Sn	3	-40°C to +125°C	CT432A SWF20DR YYWWLL
CT432-HSWF20MR	SOIC-W	16	1,000	Sn	3	-40°C to +125°C	CT432 SWF20MR YYWWLL
CT432-ASWF20MR	SOIC-W	16	1,000	Sn	3	-40°C to +125°C	CT432A SWF20MR YYWWLL
CT432-HSWF30DR	SOIC-W	16	1,000	Sn	3	-40°C to +125°C	CT432 SWF30DR YYWWLL
CT432-ASWF30DR	SOIC-W	16	1,000	Sn	3	-40°C to +125°C	CT432A SWF30DR YYWWLL
CT432-HSWF30MR	SOIC-W	16	1,000	Sn	3	-40°C to +125°C	CT432 SWF30MR YYWWLL
CT432-ASWF30MR	SOIC-W	16	1,000	Sn	3	-40°C to +125°C	CT432A SWF30MR YYWWLL
CT432-HSWF50DR	SOIC-W	16	1,000	Sn	3	-40°C to +125°C	CT432 SWF50DR YYWWLL
CT432-ASWF50DR	SOIC-W	16	1,000	Sn	3	-40°C to +125°C	CT432A SWF50DR YYWWLL
CT432-HSWF50MR	SOIC-W	16	1,000	Sn	3	-40°C to +125°C	CT432 SWF50MR YYWWLL
CT432-ASWF50MR	SOIC-W	16	1,000	Sn	3	-40°C to +125°C	CT432A SWF50MR YYWWLL
CT432-HSWF65DR	SOIC-W	16	1,000	Sn	3	-40°C to +125°C	CT432 SWF65DR YYWWLL
CT432-ASWF65DR	SOIC-W	16	1,000	Sn	3	-40°C to +125°C	CT432A SWF65DR YYWWLL

Part Number	Package Type	# of Leads	Quantity per Reel	Lead Finish	MSL Rating ⁽²⁾	Operating Temperature ⁽³⁾	Device Marking ⁽⁴⁾
CT432-HSWF65MR	SOIC-W	16	1,000	Sn	3	-40°C to +125°C	CT432 SWF65MR YYWWLL
CT432-ASWF65MR	SOIC-W	16	1,000	Sn	3	-40°C to +125°C	CT432A SWF65MR YYWWLL

- (1) RoHS is defined as semiconductor products that are compliant to the current EU RoHS requirements. It also will meet the requirement that RoHS substances do not exceed 0.1% by weight in homogeneous materials. Green is defined as the content of Chlorine (Cl), Bromine (Br) and Antimony Trioxide based flame retardants satisfy JS709B low halogen requirements of $\leq 1,000$ ppm.
- (2) MSL Rating = Moisture Sensitivity Level Rating as defined by JEDEC standard classifications.
- (3) Package will withstand ambient temperature range of -40°C to +125°C and storage temperature range of -65°C to +155°C.
- (4) Device Marking for CT432 is defined as CT432A SWFxxZR YYWWLL where the first 2 lines = part number, A is present only for Automotive parts, YY = year, WW = work week and LL = lot code.

Device Marking

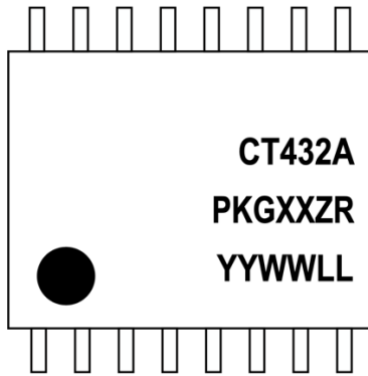

Row No.	Code	Definition
3	•	Pin 1 Indicator
1	CT432	Crocus Part Number
1	A	Present only on Automotive PNs
2	PKG	Package Type
2	XX	Maximum Current Rating
2	ZR	Polarity
3	YY	Calendar Year
3	WW	Work Week
3	LL	Lot Code

Figure 42. CT432 Device Marking for 16-lead Package

Table 3. CT432 Device Marking Definition for 16-lead SOIC-W Package

Part Number Ordering Legend

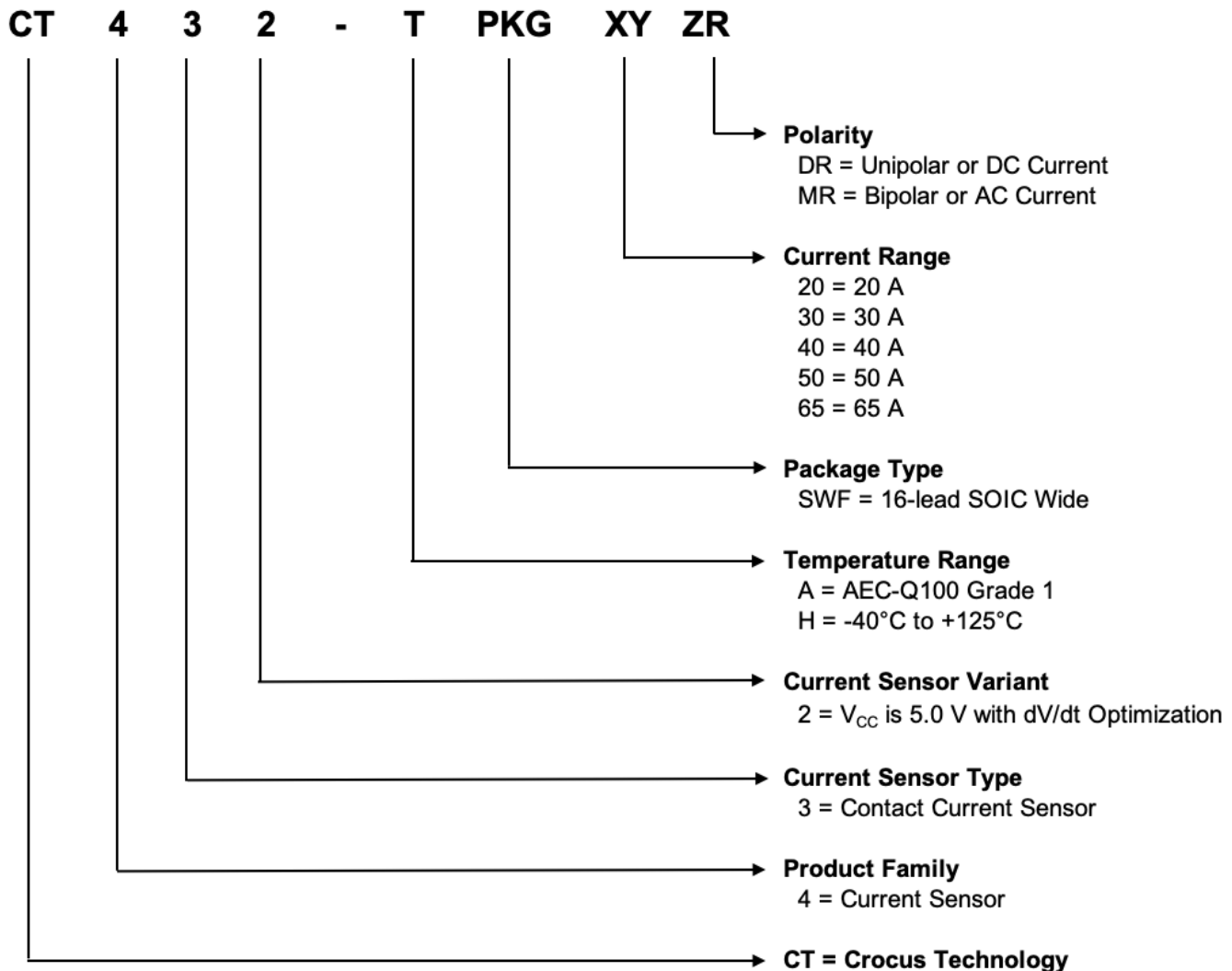

Disclaimer: The contents of this document are provided for informational purposes only. CROCUS TECHNOLOGY, INC. AND CROCUS TECHNOLOGY SA (COLLECTIVELY “CROCUS”) MAKE NO REPRESENTATIONS OR WARRANTY OF ANY KIND, EXPRESS OR IMPLIED, WITH RESPECT TO THE ACCURACY OR COMPLETENESS OF THE CONTENTS HEREIN, INCLUDING, BUT NOT LIMITED TO, THE IMPLIED WARRANTIES OF MERCHANTABILITY AND FITNESS FOR A PARTICULAR PURPOSE. Crocus reserves the right to make changes to the specifications and product descriptions, and/or to discontinue or make changes to its products at any time without notice. Crocus’s products have not been designed, tested, or manufactured for use and should not be used in applications where the failure, malfunction or inaccuracy of the Products carries a risk of death or serious bodily injury or damage to tangible property, including, but not limited to, life support systems, nuclear facilities, military, aircraft navigation or communication, emergency systems, harsh environments, or other applications with a similar degree of potential hazard.