

Accessories

AC Solid-core Current Transformer

Type CTD-8V / CTD-8H (max 30x80 mm)

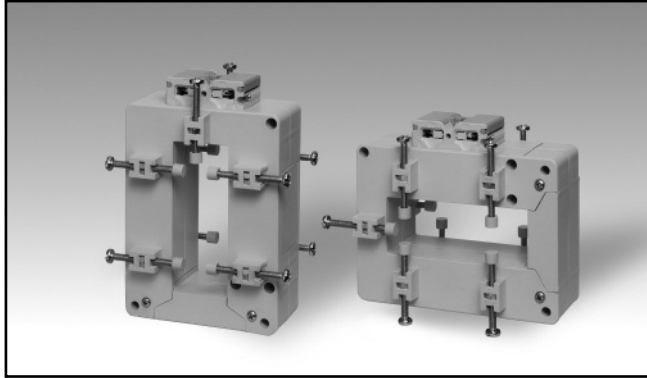

- Bus-bar type solid- core current transformer
- Class 0.5 accuracy
- Currents from 150 A to 2500 A
- Up to 10 Bus-bar isolated fixing screws
- Double screw terminals (up to 8-wire connections)
- Sealable terminal block covers

Product Description

Solid-core current transformer with bus-bar mounting facility. Rated primary currents from 150 A to 2500 A.

Ordering Key **CTD-8V 1500 5A XXX**

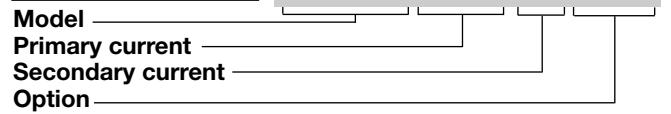

Type Selection

Model	Primary current	Secondary current	Option
CTD-8V: vertical mounting	From 150A to 2500A (Refer to the Range Table)	1A (on request) 5A	XXX: none
CTD-8H: horizontal mounting			XTX: tropicalization

Input Specifications

Operating frequency	48 to 62 Hz
Max. system voltage	0.72 kV
Rated insulation level	3 kV/1 min. @ 50 Hz
Insulation class	E (max 75°C)
Short-time current rating I_{th} I_{dyn}	Typical 100 I_n /1 s 2.5 I_{th} The short-time thermal current I_{th} is anyway limited by the cable/bus-bar size
Extended current rating	Refer to the Range Table
Security factor (FS)	≤ 5 (Class: 0.5, 1 and 3)

Working temperature	-25°C to: refer to the Range Table (-13°F to: refer to the Range Table) (R.H. < 90% non condensing @ 40°C)
Storage temperature	-30°C to +70°C (-22°F to 158°F) (R.H. < 90% non condensing @ 40°C)
Approvals	CE. cURus and CSA (150A to 1000A)
Connection Cable cross section area	Screw type From 1.5 to 6 mm ² Min/Max screws tightening torque relevant to terminal block screws: From 1 to 2 Nm Max screws tightening torque relevant to the cable/bus-bar fixing screws: 0,3 Nm
Protection degree	IP00 (without sealable terminal covers) IP20 (with sealable terminal block covers + wire terminals)
Bus-bar size	Max. 30x80 mm
Weight	From 450 to 700 g

General Specifications

Standards	According to EN61869-2
Housing	ABS, self-extinguishing: UL 94 V-0
Mounting	Bus-bar mounting
Standard accessories	Two terminal block screws. Ten bus-bar fixing screws. Ten plastic caps for bus-bar fixing screws. Two sealable terminal block covers.
Special features	1 A secondary current, Tropicalization

Output Specifications

Rated secondary current	5 A or 1 A
-------------------------	------------



Range Table

Model CTD-8V and CTD-8H from 150A to 750A					
Primary Current	Temperature	Extended current rating	Burden (VA)		
			CL 0.5	CL 1	CL 3
150	@60°C/140°F	120%	-	-	2
200	@60°C/140°F	120%	-	-	4
250	@60°C/140°F	120%	-	-	5
300	@60°C/140°F	120%	-	2	6
400	@60°C/140°F	120%	3	5	8
500	@60°C/140°F	120%	5	7	10
600	@60°C/140°F	120%	6	10	12
700	@60°C/140°F	120%	6	10	12
750	@60°C/140°F	120%	8	12	15

Model CTD-8V and CTD-8H from 800A to 2500A					
Primary Current	Temperature	Extended current rating	Burden (VA)		
			CL 0.5	CL 1	CL 3
800	@60°C/140°F	120%	8	12	15
1000	@50°C/122°F	120%	10	15	20
1200	@50°C/122°F	120%	12	15	20
1250	@50°C/122°F	120%	12	15	20
1500	@50°C/122°F	100% (+)	15	20	25
1600	@50°C/122°F	100% (*)	15	20	25
2000	@50°C/122°F	100% (*)	20	25	30
2500	@40°C/104°F	100% (*)	25	30	40

(*) A max overload of 120% for 1 min. every 30 min. is allowed.
 (+) A continuous overload of 120% of the range is allowed @ amb. temp. 40°C max.

Benefits

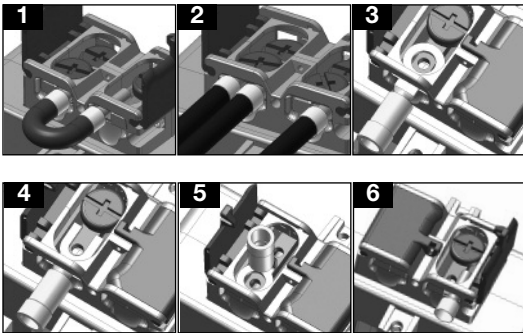

- Bridging of current transformer output without changing the connection of the secondary, so to avoid any output overvoltage during either the maintenance or the installation procedure (see figure 1).
- Easy output and earth connection (see fig. 2).
- Screw terminals compatible with any kind of wire terminals (see figure 3-4-5-6).

Dimensions Vertical mounting (mm)

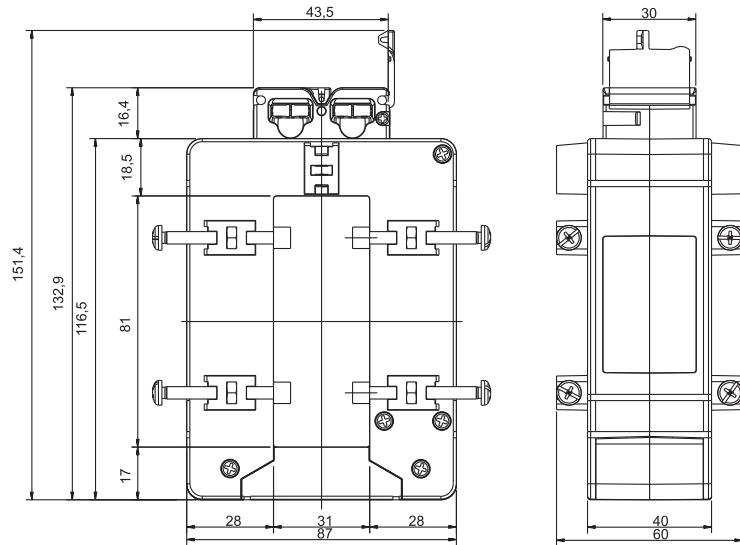

Dimensions Horizontal mounting (mm)

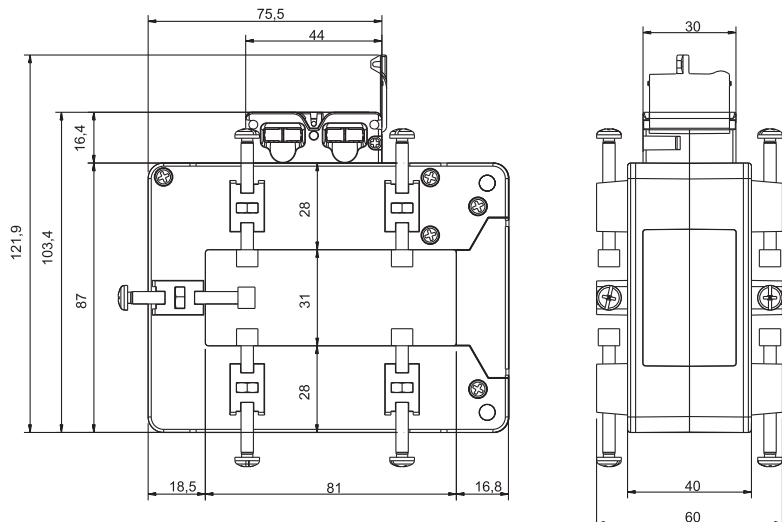

Wiring Diagram

