

CURA101-HF Thru. CURA107-HF

Reverse Voltage: 50 to 1000 Volts

Forward Current: 1.0 Amp

RoHS Device

Halogen Free

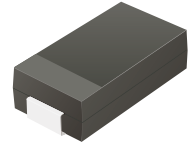

Features

- Ideal for surface mount applications.
- Easy pick and place.
- Plastic package has Underwriters Lab. flammability classification 94V-0.
- Ultra fast recovery time: 50~100nS.
- Low leakage current.

Mechanical data

- Case: JEDEC DO-214AC, molded plastic.
- Terminals: solderable per MIL-STD-750, method 2026.
- Polarity: Color band denotes cathode end.
- Approx. weight: 0.064 grams

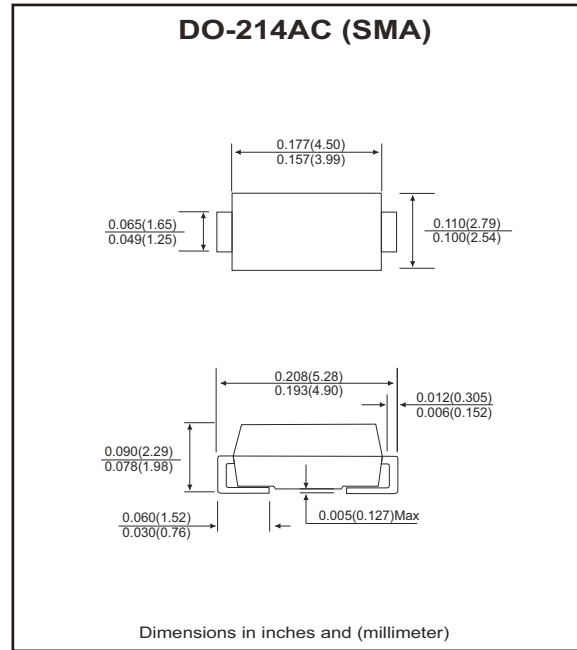

Maximum Ratings and Electrical Characteristics

Parameter	Symbol	CURA 101-HF	CURA 102-HF	CURA 103-HF	CURA 104-HF	CURA 105-HF	CURA 106-HF	CURA 107-HF	Units
Max. repetitive peak reverse voltage	V_{RRM}	50	100	200	400	600	800	1000	V
Max. DC blocking voltage	V_{DC}	50	100	200	400	600	800	1000	V
Max. RMS voltage	V_{RMS}	35	70	140	280	420	560	700	V
Peak surge forward current, 8.3ms single half sine-wave superimposed on rate load (JEDEC method)	I_{FSM}	30							A
Max. average forward rectified current At $T_A = 55^\circ\text{C}$	$I_{(AC)}$	1.0							A
Max. instantaneous forward voltage per at 1.0A	V_F	1.0		1.3		1.7		V	
Reverse recovery time	T_{rr}	50				100			nS
Typical Junction Capacitance (Measured at 1.0MHz and applied reves voltage of 4.0V)	C_J	20				15			nS
Max. DC reverse current at $T_A = 25^\circ\text{C}$ rated DC blocking voltage $T_A = 100^\circ\text{C}$	I_R	5.0				100			μA
Typical Thermal Resistance(Note 1)	$R_{\theta JL}$	88							$^\circ\text{C/W}$
	$R_{\theta JL}$	28							$^\circ\text{C/W}$
Operating junction temperature	T_J	-55 to +150							$^\circ\text{C}$
Storage temperature	T_{STG}	-55 to +150							$^\circ\text{C}$

Notes: 1. Thermal resistance from junction to lead.

RATING AND CHARACTERISTIC CURVES (CURA101-HF thru. CURA107-HF)

Fig.1- Typical Forward Current Derating Curve

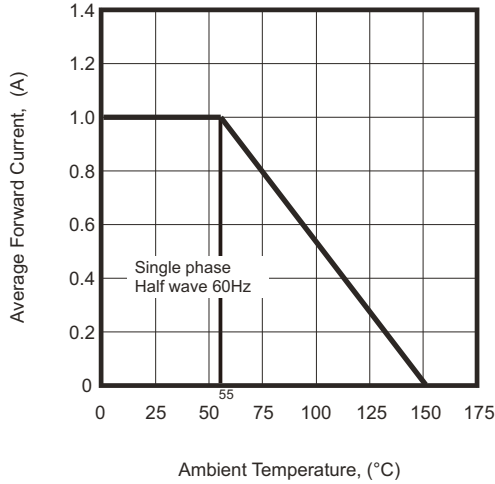

Fig.2 - Maximum NON-Repetitive Peak Forward Surge Current

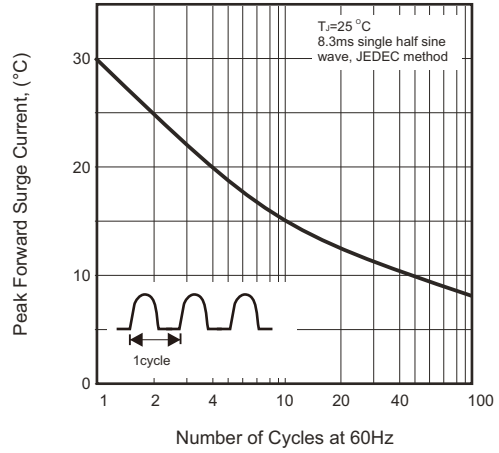

Fig.3 - Typical Instantaneous Forward Characteristics

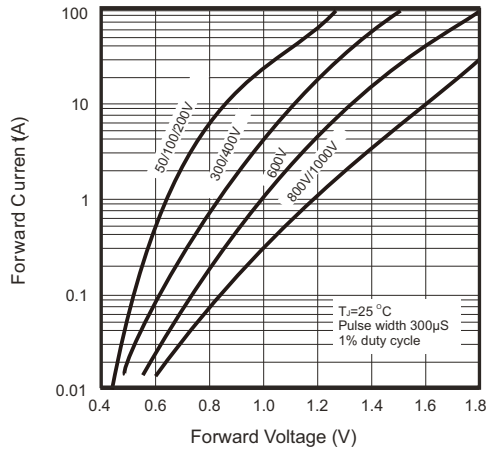

Fig.4 - Typical Reverse Characteristics

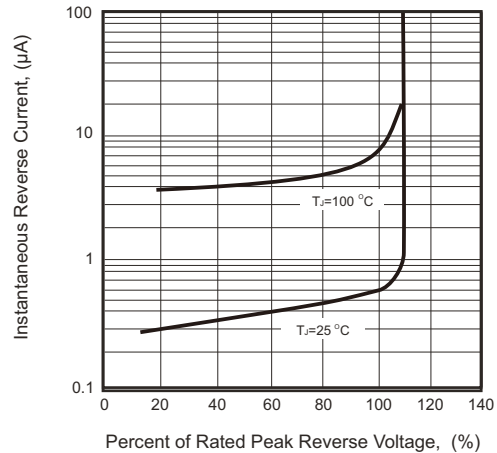

Fig.5 - Junction Capacitance

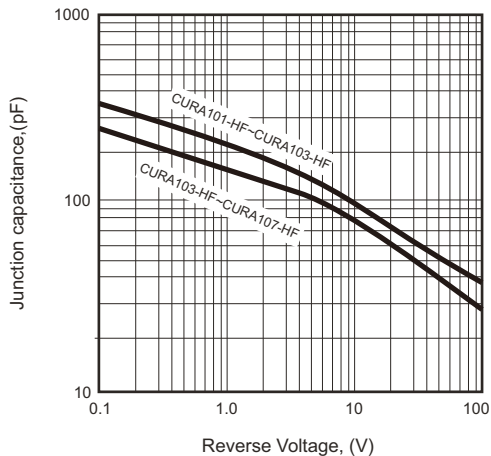
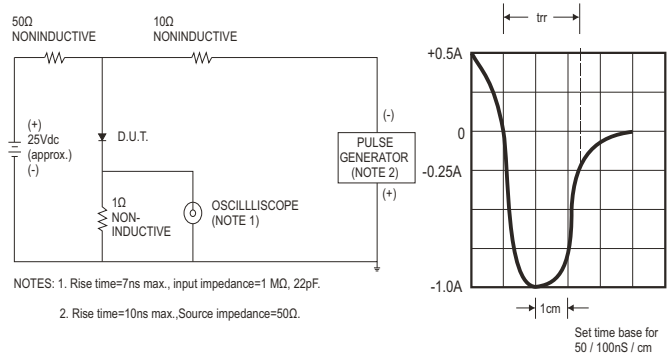
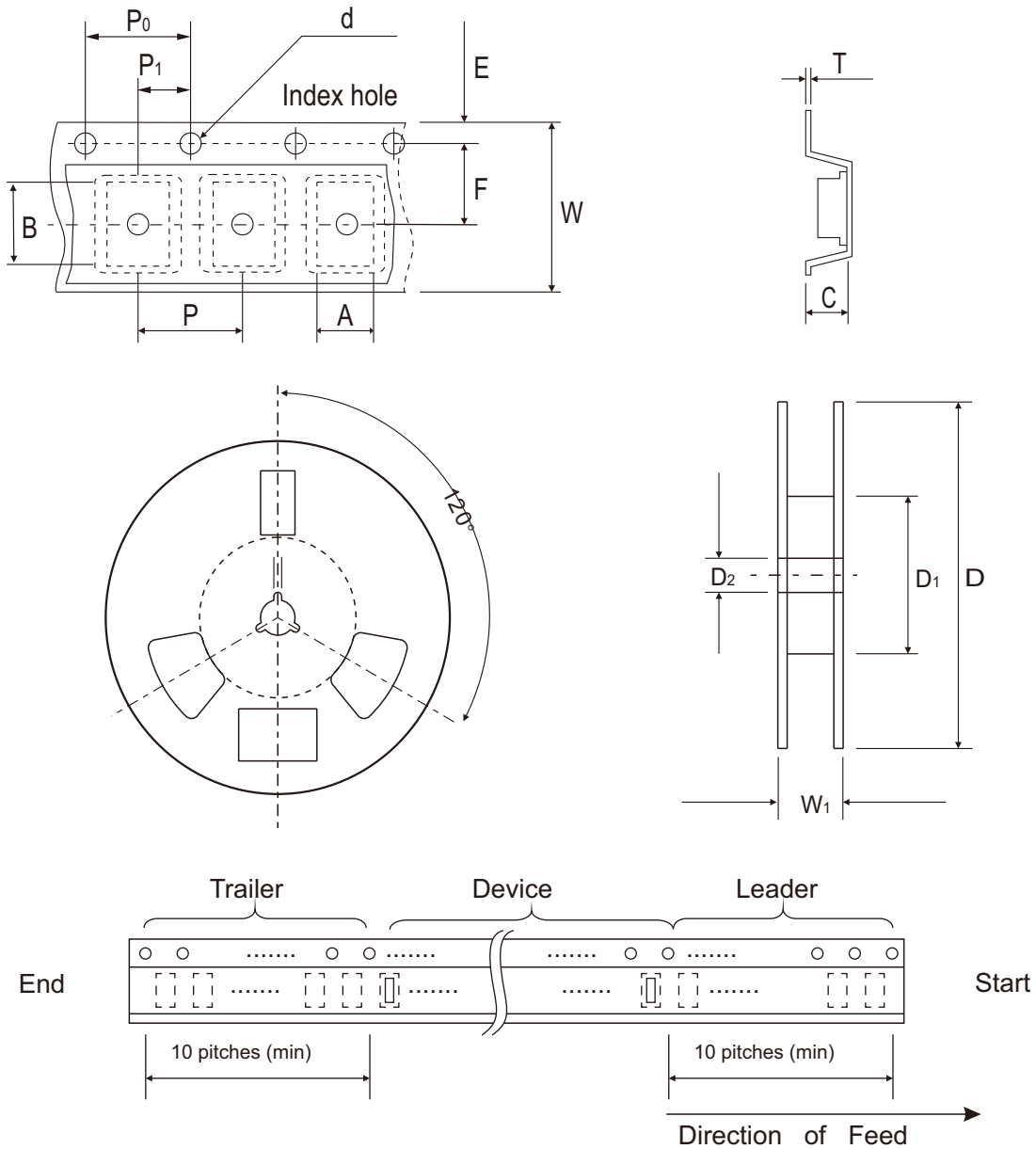

Fig.6 - Test Circuit Diagram and Reverse Recovery Time Characteristic



Reel Taping Specification



DO-214AC (SMA)	SYMBOL	A	B	C	d	D	D1	D2
	(mm)	2.7 Max	5.3 Max	2.66 Max	1.50 ± 0.10 DIA	330 ± 2.00	50.0 Min.	13.5 ± 1.00
	(inch)	0.106 Max	0.209 Max	0.105 Max	0.059 ± 0.004 DIA	13.00 ± 0.079	1.969 Min.	0.531 ± 0.039

DO-214AC (SMA)	SYMBOL	E	F	P	P0	P1	W	W1
	(mm)	1.75 ± 0.10	5.50 ± 0.05	4.00 ± 0.10	4.00 ± 0.10	2.00 ± 0.05	12.0 ± 0.30	18.4 Max.
	(inch)	0.689 ± 0.004	0.216 ± 0.002	0.157 ± 0.004	0.157 ± 0.004	0.079 ± 0.002	0.472 ± 0.012	0.724 Max