



Features

- Formerly a **KEKOVARICON** product
- Five model sizes available - 5, 7, 10, 14 and 20 mm
- Broad range of current and energy handling capabilities
- 50 to 680 V_{rms} AC voltage range; higher voltages available upon request (see the ZV Series for voltages below 50 V)
- 65 to 895 V_{dc} DC operating voltage range
- Available in tape and reel packaging for automatic pick-and-place
- RoHS compliant*

CV Series - Medium Voltage Disc Varistors

General Information

The CV series of transient surge suppressors are disc shaped varistors designed to be operated continuously in low and medium voltage electronic system circuits as well as across AC power lines.

Due to their radial lead construction, these components require very little mounting space. They are available in five model sizes: 5 mm, 7 mm, 10 mm, 14 mm and 20 mm and feature a wide AC operating voltage ranging from 50 V to 680 V.

Absolute Maximum Ratings

Parameter	Value	Units
Continuous:		
Steady State Applied Voltage		
DC Voltage Range (V_{dc})	65 to 895	V
AC Voltage Range (V_{rms})	50 to 680	V
Transient:		
Peak Single Pulse Surge Current, 8/20 μs Waveform (I_{max})	400 to 6500	A
Single Pulse Surge Energy, 10/1000 μs Waveform (W_{max})	2.7 to 620	J
Operating Ambient Temperature	-40 to +85	$^{\circ}C$
Storage Temperature Range	-40 to +125	$^{\circ}C$
Threshold Voltage Temperature Coefficient	< +0.05	%/ $^{\circ}C$
Insulation Resistance	> 1	G Ω
Isolation Voltage Capability	> 2.5	kV
Response Time	< 25	ns
Climatic Category	40 / 85 / 56	

Additional Information

Click these links for more information:



Agency Recognition

Standard	UL 1449
File Number	E313168**

Varistor Symbol

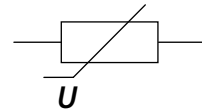

Index

Features	1
General Information	1
Agency Recognition	1
Varistor Symbol	1
Absolute Maximum Ratings	1
Device Ratings	2-3
Product Dimensions	4-6
How to Order	7
Typical Part Marking	7
Pulse Rating Curves	7-9
Packaging Drawings	10
Packaging Specifications	11-12
Assembly / Soldering Recommendations for Through-Hole Components	13
Reliability Testing Procedures	14-15
Terminology	16
Legal Disclaimer	17



Asia-Pacific: Tel: +886-2 2562-4117 • Email: asiacus@bourns.com

EMEA: Tel: +36 88 885 877 • Email: eurocus@bourns.com

The Americas: Tel: +1-951 781-5500 • Email: americus@bourns.com

www.bourns.com



WARNING Cancer and Reproductive Harm - www.P65Warnings.ca.gov

*RoHS Directive 2015/863, Mar 31, 2015 and Annex.

Specifications are subject to change without notice.

Users should verify actual device performance in their specific applications.

The products described herein and this document are subject to specific legal disclaimers as set forth on the last page of this document, and at www.bourns.com/docs/legal/disclaimer.pdf.

CV Series - Medium Voltage Disc Varistors

BOURNS®

Device Ratings

Model	V _{rms}	V _{dc}	V _n @ 1 mA	V _c	I _c	W _{max} 10/1000 μs	P max.	I _{max} 8/20 μs	C Typ. @ 1 kHz
	V	V	V	V	A	J	W	A	pF
CV 50 K 5	50	65	82	135	5	2.7	0.1	400	350
CV 50 K 7	50	65	82	135	10	6.8	0.25	1200	820
CV 50 K 10	50	65	82	135	25	17	0.4	2500	1400
CV 50 K 14	50	65	82	135	50	35	0.6	4500	2600
CV 50 K 20	50	65	82	135	100	75	1	6500	5000
CV 60 K 5	60	85	100	165	5	3	0.1	400	300
CV 60 K 7	60	85	100	165	10	7	0.25	1200	680
CV 60 K 10	60	85	100	165	25	16	0.4	2500	1200
CV 60 K 14	60	85	100	165	50	34	0.6	4500	2200
CV 60 K 20	60	85	100	165	100	71	1	6500	4100
CV 75 K 5	75	100	120	200	5	4	0.1	400	250
CV 75 K 7	75	100	120	200	10	9	0.25	1200	550
CV 75 K 10	75	100	120	200	25	21	0.4	2500	950
CV 75 K 14	75	100	120	200	50	41	0.6	4500	1800
CV 75 K 20	75	100	120	200	100	81	1	6500	3300
CV 95 K 5	95	125	150	250	5	6	0.1	400	200
CV 95 K 7	95	125	150	250	10	11	0.25	1200	440
CV 95 K 10	95	125	150	250	25	25	0.4	2500	750
CV 95 K 14	95	125	150	250	50	51	0.6	4500	1400
CV 95 K 20	95	125	150	250	100	106	1	6500	2600
CV 115 K 5	115	150	180	300	5	6	0.1	400	170
CV 115 K 7	115	150	180	300	10	13	0.25	1200	360
CV 115 K 10	115	150	180	300	25	30	0.4	2500	650
CV 115 K 14	115	150	180	300	50	62	0.6	4500	1200
CV 115 K 20	115	150	180	300	100	118	1	6500	2100
CV 130 K 5	130	170	205	340	5	7	0.1	400	150
CV 130 K 7	130	170	205	340	10	15	0.25	1200	320
CV 130 K 10	130	170	205	340	25	34	0.4	2500	580
CV 130 K 14	130	170	205	340	50	68	0.6	4500	1050
CV 130 K 20	130	170	205	340	100	142	1	6500	1900
CV 140 K 5	140	180	220	360	5	7	0.1	400	140
CV 140 K 7	140	180	220	360	10	18	0.25	1200	1200
CV 140 K 10	140	180	220	360	25	37	0.4	2500	2500
CV 140 K 14	140	180	220	360	50	75	0.6	4500	4500
CV 140 K 20	140	180	220	360	100	157	1	6500	6500
CV 150 K 5	150	200	240	395	5	9	0.1	400	130
CV 150 K 7	150	200	240	395	10	18	0.25	1200	280
CV 150 K 10	150	200	240	395	25	41	0.4	2500	510
CV 150 K 14	150	200	240	395	50	81	0.6	4500	900
CV 150 K 20	150	200	240	395	100	170	1	6500	1550
CV 175 K 5	175	225	270	455	5	9.5	0.1	400	120
CV 175 K 7	175	225	270	455	10	21	0.25	1200	250
CV 175 K 10	175	225	270	455	25	46	0.4	2500	440
CV 175 K 14	175	225	270	455	50	95	0.6	4500	800
CV 175 K 20	175	225	270	455	100	193	1	6500	1400

Continued on Next Page

Specifications are subject to change without notice.

Users should verify actual device performance in their specific applications.

The products described herein and this document are subject to specific legal disclaimers as set forth on the last page of this document, and at www.bourns.com/docs/legal/disclaimer.pdf.

CV Series - Medium Voltage Disc Varistors

BOURNS®

Device Ratings (Continued)

Model	V _{rms}	V _{dc}	V _n @ 1 mA	V _c	I _c	W _{max} 10/1000 μs	P max.	I _{max} 8/20 μs	C Typ. @ 1 kHz
	V	V	V	V	A	J	W	A	pF
CV 230 K 5	230	300	360	595	5	13	0.1	400	90
CV 230 K 7	230	300	360	595	10	28	0.25	1200	190
CV 230 K 10	230	300	360	595	25	62	0.4	2500	350
CV 230 K 14	230	300	360	595	50	126	0.6	4500	650
CV 230 K 20	230	300	360	595	100	258	1	6500	1200
CV 250 K 5	250	320	390	650	5	14	0.1	400	80
CV 250 K 7	250	320	390	650	10	30	0.25	1200	180
CV 250 K 10	250	320	390	650	25	68	0.4	2500	320
CV 250 K 14	250	320	390	650	50	135	0.6	4500	580
CV 250 K 20	250	320	390	650	100	276	1	6500	1000
CV 275 K 5	275	350	430	710	5	16	0.1	400	70
CV 275 K 7	275	350	430	710	10	35	0.25	1200	160
CV 275 K 10	275	350	430	710	25	78	0.4	2500	300
CV 275 K 14	275	350	430	710	50	150	0.6	4500	530
CV 275 K 20	275	350	430	710	100	304	1	6500	900
CV 300 K 5	300	385	470	775	5	21	0.1	400	65
CV 300 K 7	300	385	470	775	10	37	0.25	1200	150
CV 300 K 10	300	385	470	775	25	82	0.4	2500	280
CV 300 K 14	300	385	470	775	50	169	0.6	4500	490
CV 300 K 20	300	385	470	775	100	350	1	6500	850
CV 320 K 10	320	420	510	840	25	91	0.4	2500	260
CV 320 K 14	320	420	510	840	50	184	0.6	4500	460
CV 320 K 20	320	420	510	840	100	388	1	6500	800
CV 385 K 10	385	505	620	1025	25	93	0.4	2500	240
CV 385 K 14	385	505	620	1025	50	193	0.6	4500	400
CV 385 K 20	385	505	620	1025	100	396	1	6500	700
CV 420 K 10	420	560	680	1120	25	97	0.4	2500	220
CV 420 K 14	420	560	680	1120	50	202	0.6	4500	350
CV 420 K 20	420	560	680	1120	100	418	1	6500	650
CV 460 K 10	460	615	750	1240	25	106	0.4	2500	200
CV 460 K 14	460	615	750	1240	50	220	0.6	4500	330
CV 460 K 20	460	615	750	1240	100	460	1	6500	550
CV 510 K 10	510	670	820	1355	25	115	0.4	2500	180
CV 510 K 14	510	670	820	1355	50	227	0.6	4500	310
CV 510 K 20	510	670	820	1355	100	478	1	6500	500
CV 550 K 10	550	745	910	1500	25	134	0.4	2500	170
CV 550 K 14	550	745	910	1500	50	264	0.6	4500	290
CV 550 K 20	550	745	910	1500	100	515	1	6500	450
CV 625 K 10	625	825	1000	1650	25	140	0.4	2500	160
CV 625 K 14	625	825	1000	1650	50	280	0.6	4500	270
CV 625 K 20	625	825	1000	1650	100	565	1	6500	400
CV 680 K 10	680	895	1100	1815	25	155	0.4	2500	150
CV 680 K 14	680	895	1100	1815	50	310	0.6	4500	250
CV 680 K 20	680	895	1100	1815	100	620	1	6500	350

Specifications are subject to change without notice.

Users should verify actual device performance in their specific applications.

The products described herein and this document are subject to specific legal disclaimers as set forth on the last page of this document, and at www.bourns.com/docs/legal/disclaimer.pdf.

CV Series - Medium Voltage Disc Varistors

BOURNS®

Product Dimensions

Model	Dimension					
	D (Max.)	t (Max.)	R	d	h (Max.)	a
CV 50 K 5	7 (.276)	3.5 (.138)	5 (.197)	0.6 (.024)	9.5 (.374)	1.0 (.039)
CV 50 K 7	9 (.354)	3.5 (.138)	5 (.197)	0.6 (.024)	11.5 (.453)	1.0 (.039)
CV 50 K 10	12.5 (.492)	4.1 (.161)	7.5 (.295)	0.8 (.031)	15 (.591)	1.3 (.051)
CV 50 K 14	16.5 (.650)	4.1 (.161)	7.5 (.295)	0.8 (.031)	20 (.787)	1.4 (.055)
CV 50 K 20	22.5 (.886)	4.5 (.177)	10 (.394)	1.0 (.039)	26 (1.024)	1.6 (.063)
CV 60 K 5	7 (.276)	3.5 (.138)	5 (.197)	0.6 (.024)	9.5 (.374)	1.1 (.043)
CV 60 K 7	9 (.354)	3.5 (.138)	5 (.197)	0.6 (.024)	11.5 (.453)	1.1 (.043)
CV 60 K 10	12.5 (.492)	4.1 (.161)	7.5 (.295)	0.8 (.031)	15 (.591)	1.4 (.055)
CV 60 K 14	16.5 (.650)	4.2 (.165)	7.5 (.295)	0.8 (.031)	20 (.787)	1.5 (.059)
CV 60 K 20	22.5 (.886)	4.6 (.186)	10 (.394)	1.0 (.039)	26 (1.024)	1.7 (.067)
CV 75 K 5	7 (.276)	3.6 (.142)	5 (.197)	0.6 (.024)	9.5 (.374)	1.2 (.047)
CV 75 K 7	9 (.354)	3.6 (.142)	5 (.197)	0.6 (.024)	11.5 (.453)	1.2 (.047)
CV 75 K 10	12.5 (.492)	4.2 (.165)	7.5 (.295)	0.8 (.031)	15 (.591)	1.5 (.059)
CV 75 K 14	16.5 (.650)	4.2 (.165)	7.5 (.295)	0.8 (.031)	20 (.787)	1.5 (.059)
CV 75 K 20	22.5 (.886)	4.6 (.186)	10 (.394)	1.0 (.039)	26 (1.024)	1.7 (.067)
CV 95 K 5	7 (.276)	3.8 (.150)	5 (.197)	0.6 (.024)	9.5 (.374)	1.4 (.055)
CV 95 K 7	9 (.354)	3.8 (.150)	5 (.197)	0.6 (.024)	11.5 (.453)	1.4 (.055)
CV 95 K 10	12.5 (.492)	4.3 (.169)	7.5 (.295)	0.8 (.031)	15 (.591)	1.7 (.067)
CV 95 K 14	16.5 (.650)	4.3 (.169)	7.5 (.295)	0.8 (.031)	20 (.787)	1.7 (.067)
CV 95 K 20	22.5 (.886)	4.6 (.186)	10 (.394)	1.0 (.039)	26 (1.024)	1.9 (.075)
CV 115 K 5	7 (.276)	4.0 (.157)	5 (.197)	0.6 (.024)	9.5 (.374)	1.6 (.063)
CV 115 K 7	9 (.354)	4.0 (.157)	5 (.197)	0.6 (.024)	11.5 (.453)	1.6 (.063)
CV 115 K 10	12.5 (.492)	4.3 (.169)	7.5 (.295)	0.8 (.031)	15 (.591)	1.9 (.075)
CV 115 K 14	16.5 (.650)	4.4 (.173)	7.5 (.295)	0.8 (.031)	20 (.787)	1.9 (.075)
CV 115 K 20	22.5 (.886)	4.8 (.189)	10 (.394)	1.0 (.039)	26 (1.024)	2.1 (.083)
CV 130 K 5	7 (.276)	4.0 (.157)	5 (.197)	0.6 (.024)	9.5 (.374)	1.8 (.071)
CV 130 K 7	9 (.354)	4.0 (.157)	5 (.197)	0.6 (.024)	11.5 (.453)	1.8 (.071)
CV 130 K 10	12.5 (.492)	4.5 (.177)	7.5 (.295)	0.8 (.031)	15 (.591)	2.0 (.079)
CV 130 K 14	16.5 (.650)	4.6 (.186)	7.5 (.295)	0.8 (.031)	20 (.787)	2.0 (.079)
CV 130 K 20	22.5 (.886)	5.0 (.197)	10 (.394)	1.0 (.039)	26 (1.024)	2.2 (.087)

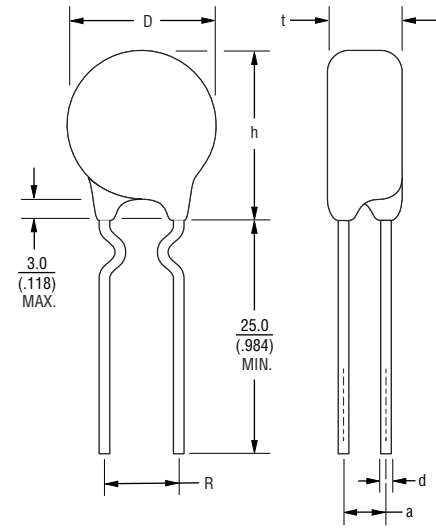
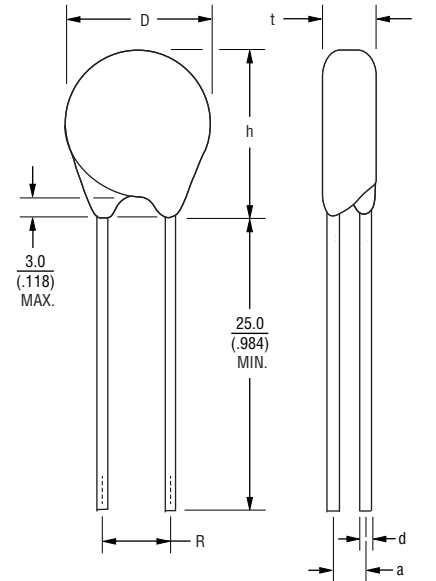

DIMENSIONS: $\frac{\text{MM}}{\text{(INCHES)}}$

Specifications are subject to change without notice.

Users should verify actual device performance in their specific applications.

The products described herein and this document are subject to specific legal disclaimers as set forth on the last page of this document, and at www.bourns.com/docs/legal/disclaimer.pdf.

CV Series - Medium Voltage Disc Varistors

BOURNS®

Product Dimensions (Continued)

Model	Dimension					
	D (Max.)	t (Max.)	R	d	h (Max.)	a
CV 140 K 5	7 (.276)	4.1 (.161)	5 (.197)	0.6 (.024)	9.5 (.374)	1.9 (.075)
CV 140 K 7	9 (.354)	4.1 (.161)	5 (.197)	0.6 (.024)	11.5 (.453)	1.9 (.075)
CV 140 K 10	12.5 (.492)	4.6 (.186)	7.5 (.295)	0.8 (.031)	15 (.591)	2.1 (.083)
CV 140 K 14	16.5 (.650)	4.7 (.185)	7.5 (.295)	0.8 (.031)	20 (.787)	2.1 (.083)
CV 140 K 20	22.5 (.886)	5.1 (.201)	10 (.394)	1.0 (.039)	26 (1.024)	2.3 (.091)
CV 150 K 5	7 (.276)	4.3 (.169)	5 (.197)	0.6 (.024)	9.5 (.374)	2.0 (.079)
CV 150 K 7	9 (.354)	4.3 (.169)	5 (.197)	0.6 (.024)	11.5 (.453)	2.0 (.079)
CV 150 K 10	12.5 (.492)	4.6 (.186)	7.5 (.295)	0.8 (.031)	15 (.591)	2.2 (.087)
CV 150 K 14	16.5 (.650)	4.8 (.189)	7.5 (.295)	0.8 (.031)	20 (.787)	2.2 (.087)
CV 150 K 20	22.5 (.886)	5.2 (.205)	10 (.394)	1.0 (.039)	26 (1.024)	2.4 (.094)
CV 175 K 5	7 (.276)	4.8 (.189)	5 (.197)	0.6 (.024)	9.5 (.374)	2.1 (.083)
CV 175 K 7	9 (.354)	4.8 (.189)	5 (.197)	0.6 (.024)	11.5 (.453)	2.1 (.083)
CV 175 K 10	12.5 (.492)	4.9 (.193)	7.5 (.295)	0.8 (.031)	15 (.591)	2.3 (.091)
CV 175 K 14	16.5 (.650)	4.9 (.193)	7.5 (.295)	0.8 (.031)	20 (.787)	2.3 (.091)
CV 175 K 20	22.5 (.886)	5.3 (.209)	10 (.394)	1.0 (.039)	26 (1.024)	2.5 (.098)
CV 230 K 5	7 (.276)	4.8 (.189)	5 (.197)	0.6 (.024)	9.5 (.374)	2.6 (.102)
CV 230 K 7	9 (.354)	4.8 (.189)	5 (.197)	0.6 (.024)	11.5 (.453)	2.6 (.102)
CV 230 K 10	12.5 (.492)	5.4 (.213)	7.5 (.295)	0.8 (.031)	15 (.591)	2.8 (.110)
CV 230 K 14	16.5 (.650)	5.5 (.217)	7.5 (.295)	0.8 (.031)	20 (.787)	2.8 (.110)
CV 230 K 20	22.5 (.886)	5.9 (.232)	10 (.394)	1.0 (.039)	26 (1.024)	3.0 (.118)
CV 250 K 5	7 (.276)	5.0 (.197)	5 (.197)	0.6 (.024)	9.5 (.374)	2.8 (.110)
CV 250 K 7	9 (.354)	5.0 (.197)	5 (.197)	0.6 (.024)	11.5 (.453)	2.8 (.110)
CV 250 K 10	12.5 (.492)	5.6 (.220)	7.5 (.295)	0.8 (.031)	15 (.591)	3.0 (.118)
CV 250 K 14	16.5 (.650)	5.7 (.224)	7.5 (.295)	0.8 (.031)	20 (.787)	3.0 (.118)
CV 250 K 20	22.5 (.886)	6.1 (.240)	10 (.394)	1.0 (.039)	26 (1.024)	3.2 (.126)
CV 275 K 5	7 (.276)	5.6 (.220)	5 (.197)	0.6 (.024)	9.5 (.374)	3.0 (.118)
CV 275 K 7	9 (.354)	5.6 (.220)	5 (.197)	0.6 (.024)	11.5 (.453)	3.0 (.118)
CV 275 K 10	12.5 (.492)	6.0 (.236)	7.5 (.295)	0.8 (.031)	15 (.591)	3.2 (.126)
CV 275 K 14	16.5 (.650)	6.0 (.236)	7.5 (.295)	0.8 (.031)	20 (.787)	3.2 (.126)
CV 275 K 20	22.5 (.886)	6.3 (.248)	10 (.394)	1.0 (.039)	26 (1.024)	3.4 (.134)

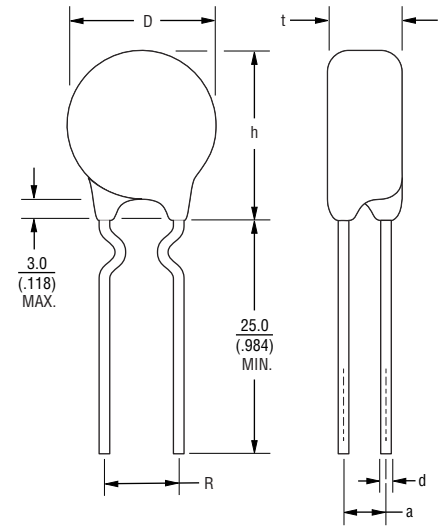
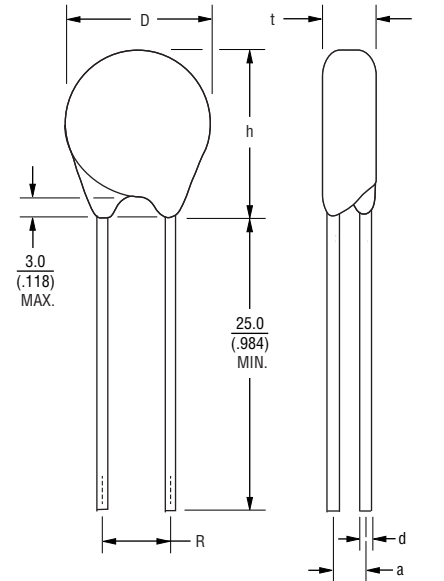

DIMENSIONS: $\frac{\text{MM}}{\text{(INCHES)}}$

Specifications are subject to change without notice.

Users should verify actual device performance in their specific applications.

The products described herein and this document are subject to specific legal disclaimers as set forth on the last page of this document, and at www.bourns.com/docs/legal/disclaimer.pdf.

CV Series - Medium Voltage Disc Varistors

BOURNS®

Product Dimensions (Continued)

Model	Dimension					
	D (Max.)	t (Max.)	R	d	h (Max.)	a
CV 300 K 5	7 (.276)	5.8 (.228)	5 (.197)	0.6 (.024)	9.5 (.374)	3.2 (.126)
CV 300 K 7	9 (.354)	5.8 (.228)	5 (.197)	0.6 (.024)	11.5 (.453)	3.2 (.126)
CV 300 K 10	12.5 (.492)	6.1 (.240)	7.5 (.295)	0.8 (.031)	15 (.591)	3.4 (.134)
CV 300 K 14	16.5 (.650)	6.1 (.240)	7.5 (.295)	0.8 (.031)	20 (.787)	3.4 (.134)
CV 300 K 20	22.5 (.886)	6.6 (.260)	10 (.394)	1.0 (.039)	26 (1.024)	3.6 (.141)
CV 320 K 10	12.5 (.492)	6.8 (.268)	7.5 (.295)	0.8 (.031)	16 (.630)	3.6 (.141)
CV 320 K 14	16.5 (.650)	6.8 (.268)	7.5 (.295)	0.8 (.031)	21 (.827)	3.6 (.141)
CV 320 K 20	22.5 (.886)	6.8 (.268)	10 (.394)	1.0 (.039)	27 (1.063)	3.8 (.150)
CV 385 K 10	12.5 (.492)	7.4 (.291)	7.5 (.295)	0.8 (.031)	16 (.630)	4.2 (.165)
CV 385 K 14	16.5 (.650)	7.4 (.291)	7.5 (.295)	0.8 (.031)	21 (.827)	4.2 (.165)
CV 385 K 20	22.5 (.886)	7.5 (.295)	10 (.394)	1.0 (.039)	27 (1.063)	4.4 (.173)
CV 420 K 10	12.5 (.492)	7.3 (.287)	7.5 (.295)	0.8 (.031)	16 (.630)	4.4 (.173)
CV 420 K 14	16.5 (.650)	7.4 (.291)	7.5 (.295)	0.8 (.031)	21 (.827)	4.4 (.173)
CV 420 K 20	22.5 (.886)	7.8 (.307)	10 (.394)	1.0 (.039)	27 (1.063)	4.6 (.181)
CV 460 K 10	12.5 (.492)	7.8 (.307)	7.5 (.295)	0.8 (.031)	16 (.630)	4.8 (.189)
CV 460 K 14	16.5 (.650)	7.8 (.307)	7.5 (.295)	0.8 (.031)	21 (.827)	4.8 (.189)
CV 460 K 20	22.5 (.886)	8.2 (.323)	10 (.394)	1.0 (.039)	27 (1.063)	5.0 (.197)
CV 510 K 10	12.5 (.492)	8.2 (.323)	7.5 (.295)	0.8 (.031)	16 (.630)	5.1 (.201)
CV 510 K 14	16.5 (.650)	8.2 (.323)	7.5 (.295)	0.8 (.031)	21 (.827)	5.1 (.201)
CV 510 K 20	22.5 (.886)	8.7 (.343)	10 (.394)	1.0 (.039)	27 (1.063)	5.3 (.209)
CV 550 K 10	12.5 (.492)	8.8 (.346)	7.5 (.295)	0.8 (.031)	16 (.630)	5.6 (.220)
CV 550 K 14	16.5 (.650)	8.8 (.346)	7.5 (.295)	0.8 (.031)	21 (.827)	5.6 (.220)
CV 550 K 20	22.5 (.886)	9.2 (.362)	10 (.394)	1.0 (.039)	27 (1.063)	5.8 (.228)
CV 625 K 10	12.5 (.492)	9.1 (.358)	7.5 (.295)	0.8 (.031)	16 (.630)	6.1 (.240)
CV 625 K 14	16.5 (.650)	9.2 (.362)	7.5 (.295)	0.8 (.031)	21 (.827)	6.1 (.240)
CV 625 K 20	22.5 (.886)	9.7 (.382)	10 (.394)	1.0 (.039)	27 (1.063)	6.3 (.248)
CV 680 K 10	12.5 (.492)	9.7 (.382)	7.5 (.295)	0.8 (.031)	16 (.630)	6.6 (.260)
CV 680 K 14	16.5 (.650)	9.8 (.386)	7.5 (.295)	0.8 (.031)	21 (.827)	6.6 (.260)
CV 680 K 20	22.5 (.886)	10.2 (.402)	10 (.394)	1.0 (.039)	27 (1.063)	6.8 (.268)

DIMENSIONS: $\frac{\text{MM}}{\text{(INCHES)}}$

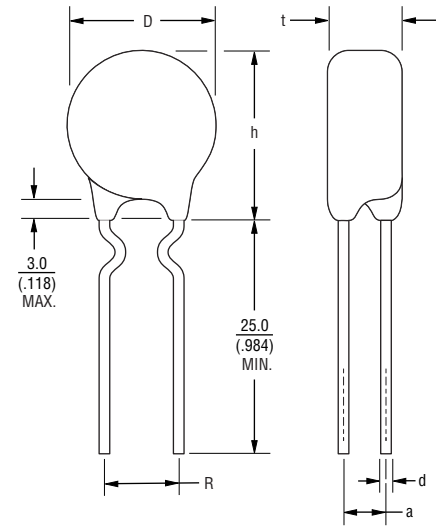
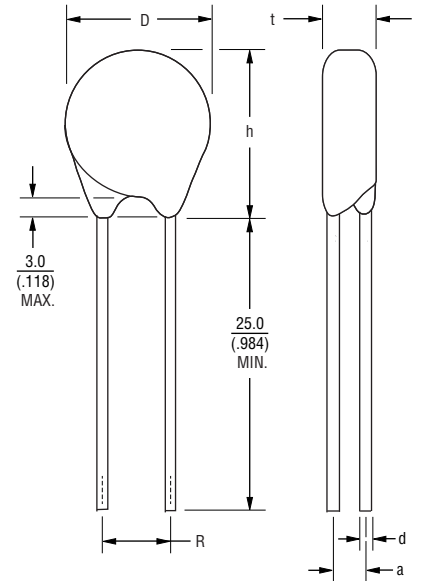

Typical Part Marking

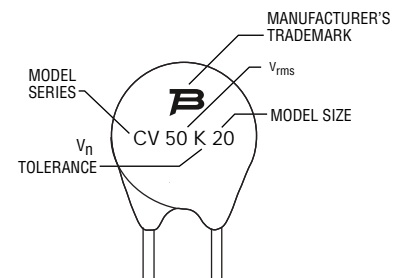

Specifications are subject to change without notice.

Users should verify actual device performance in their specific applications.

The products described herein and this document are subject to specific legal disclaimers as set forth on the last page of this document, and at www.bourns.com/docs/legal/disclaimer.pdf.

CV Series - Medium Voltage Disc Varistors

BOURNS®

How to Order

CV130K14RL1yy

Series Designator _____
 CV = CV Series

Max. Continuous Operating Voltage (V_{rms}) _____
 V_n Tolerance _____
 K = $\pm 10\%$

Model Size _____
 5 = 5 mm 14 = 14 mm
 7 = 7 mm 20 = 20 mm
 10 = 10 mm

Packaging _____
 R = Reel*
 B = Bulk
 A = Ammo Pack (Available only upon special request)*
 *Reel and Ammo Pack options not available for Model Size 20.

Lead Style _____
 L1 = Straight Leads
 L5 = Crimped Leads

Special Parameters _____
 YY = Unique two digit suffix is assigned to each customer requesting special parameters.
 Please contact Bourns for more information.

Instructions for Creating Orderable Part Number:

- 1) Start with base part number in characteristics table
 (example: CV130K14).
- 2) Add Packaging: R
 (example part number becomes CV130K14R).
- 3) Add Lead Style: L1
 (example part number becomes CV130K14RL1).
- 4) Part number can have no spaces or lower case letters.

Pulse Rating Curves - Protection level with worst-case condition in the tolerance region

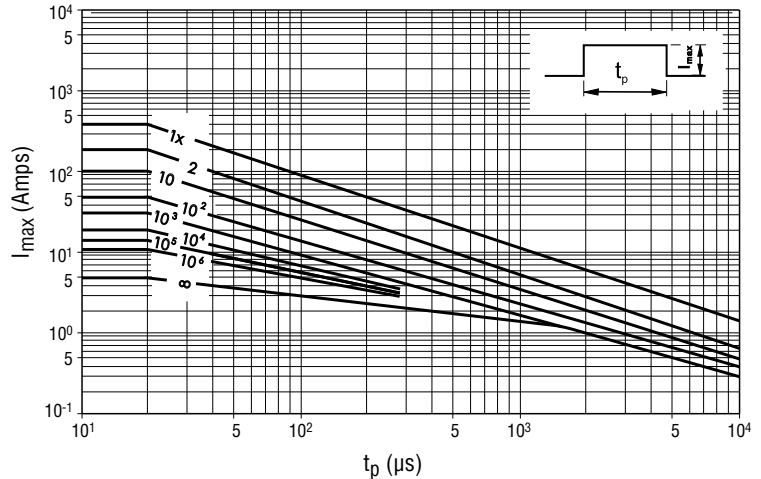
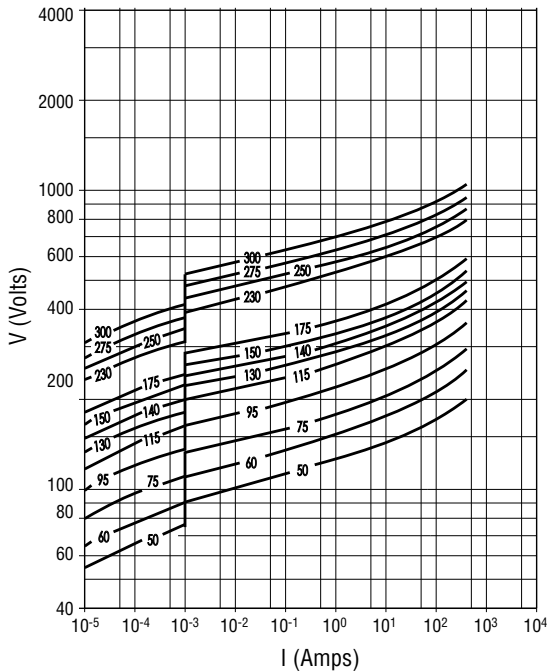

Specifications are subject to change without notice.
 Users should verify actual device performance in their specific applications.
 The products described herein and this document are subject to specific legal disclaimers as set forth on the last page of this document, and at www.bourns.com/docs/legal/disclaimer.pdf.

CV Series - Medium Voltage Disc Varistors

BOURNS®

Pulse Rating Curves (Continued) - Protection level with worst-case condition in the tolerance region

Model Size 7 - (CV50 ~ CV300)

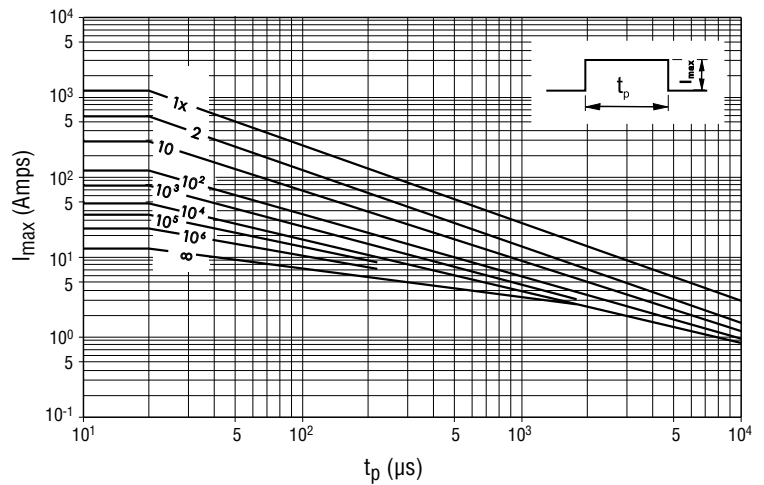
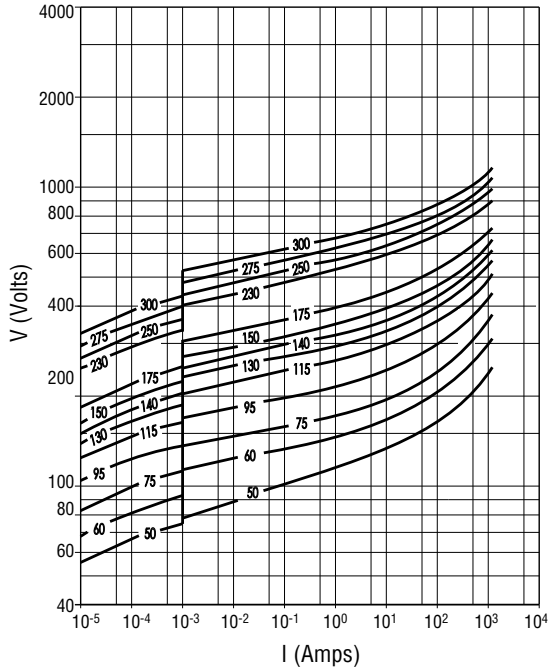

Model Size 10 - (CV50 ~ CV680)

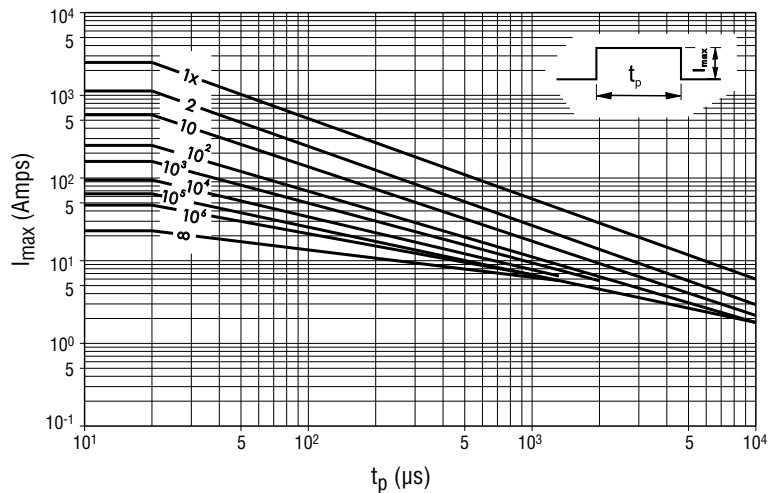
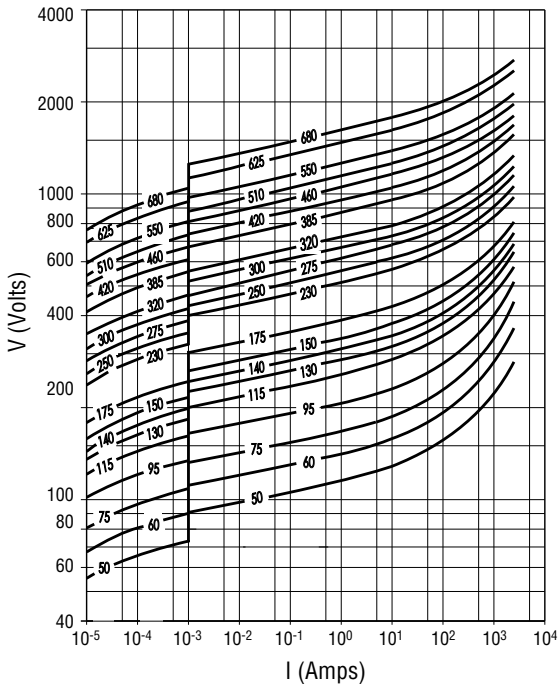

Specifications are subject to change without notice.

Users should verify actual device performance in their specific applications.

The products described herein and this document are subject to specific legal disclaimers as set forth on the last page of this document, and at www.bourns.com/docs/legal/disclaimer.pdf.

Pulse Rating Curves (Continued) - Protection level with worst-case condition in the tolerance region

Model Size 14 - (CV50 ~ CV680)

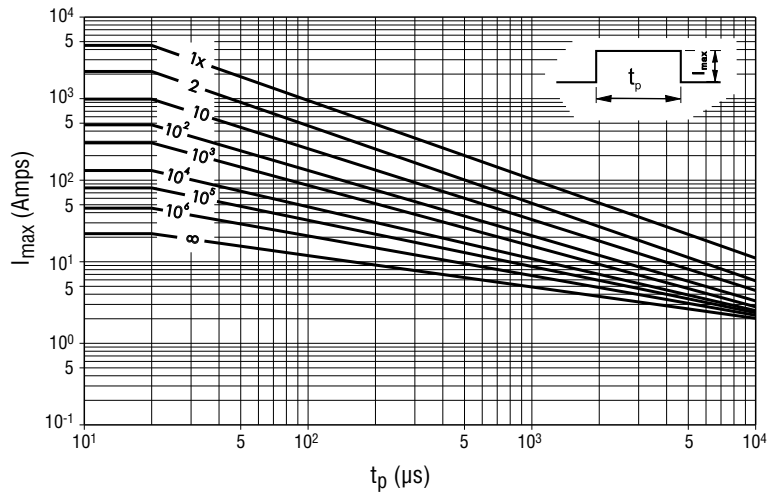
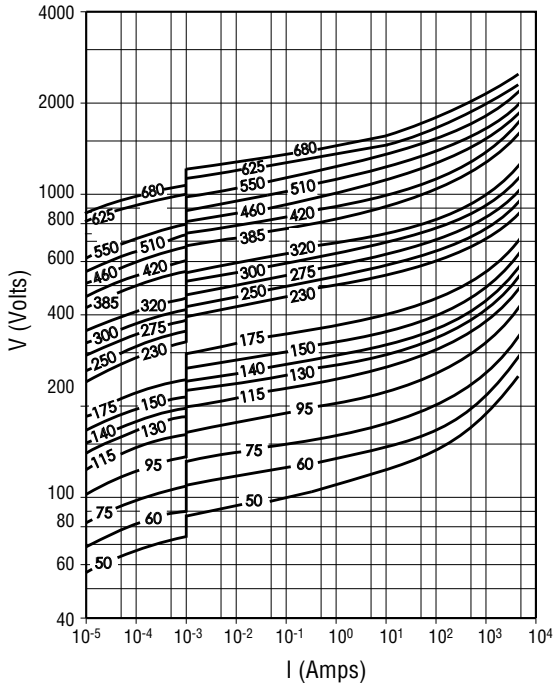

Model Size 20 - (CV50 ~ CV680)

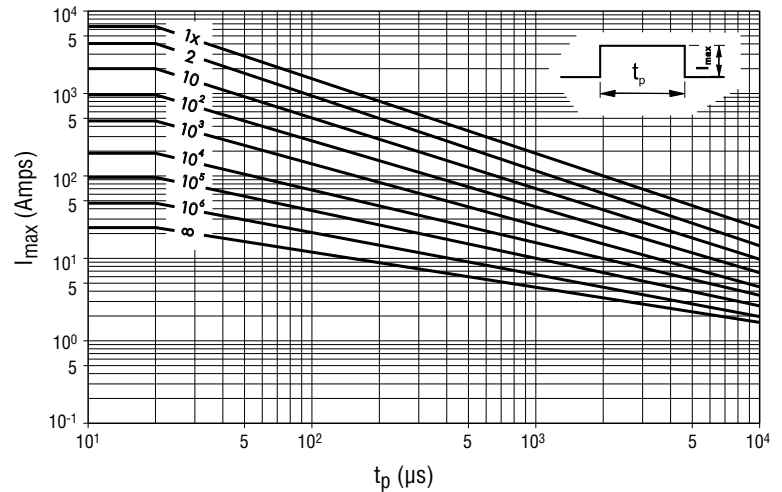
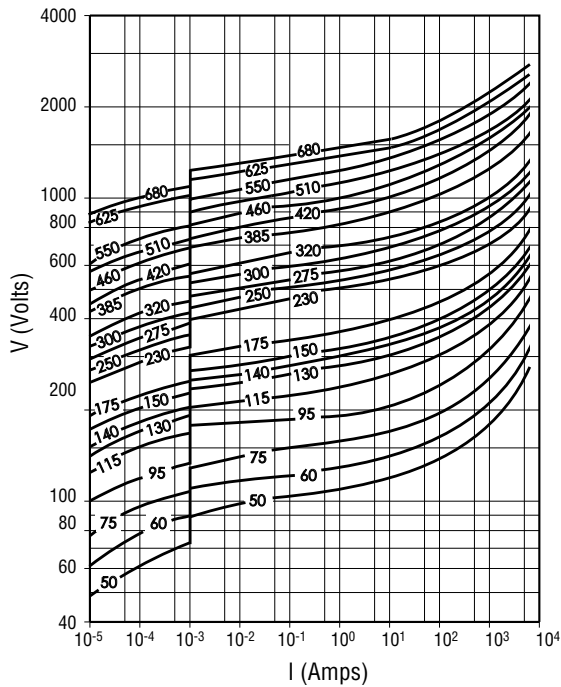

Specifications are subject to change without notice.

Users should verify actual device performance in their specific applications.

The products described herein and this document are subject to specific legal disclaimers as set forth on the last page of this document, and at www.bourns.com/docs/legal/disclaimer.pdf.

CV Series - Medium Voltage Disc Varistors

BOURNS®

Packaging Specifications - Tape

Conforms to IES Publication 286-2 Ed. 3: 2008-03

Dimension R = 5 mm

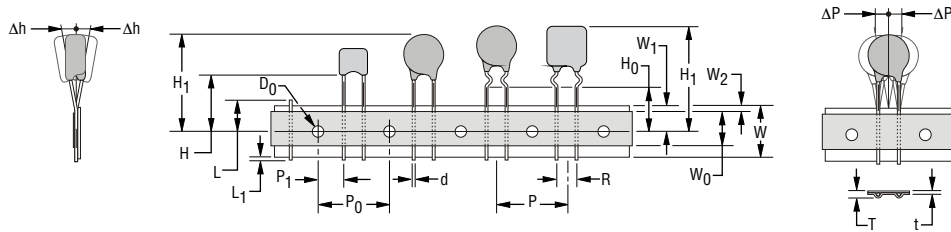

Dimensions on Next Page

Dimension R = 7.5 mm & 10 mm

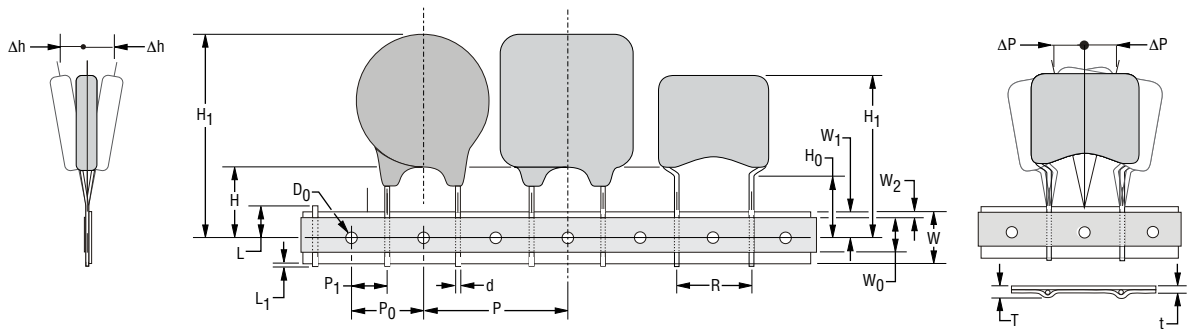

Dimensions on Next Page

Reel

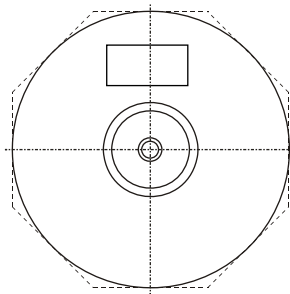
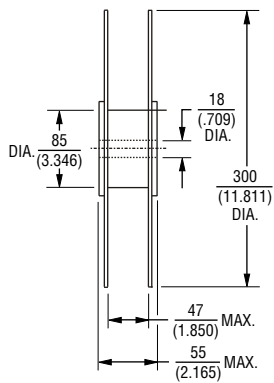

DIMENSIONS: $\frac{\text{MM}}{\text{(INCHES)}}$

Ammo Pack (Available upon Special Request)

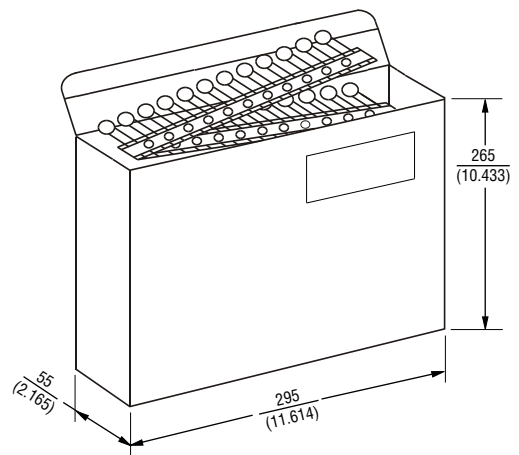

Specifications are subject to change without notice.

Users should verify actual device performance in their specific applications.

The products described herein and this document are subject to specific legal disclaimers as set forth on the last page of this document, and at www.bourns.com/docs/legal/disclaimer.pdf.

Packaging Specifications - Tape (Continued)

Symbol	Parameter	Model Size				
		5	7	10	14	20
W	Carrier tape width	$\frac{18 + 1.0/-0.5}{(.709 + .039/- .020)}$				
W ₀	Hold down tape width	$\frac{5}{(.197)}$ MIN.				
W ₁	Sprocket hole position	$\frac{9 + 0.75/-0.5}{(.354 + .030/- .020)}$				
W ₂	Distance between the upper edges of the carrier tape and hold down tape	$\frac{3}{(.118)}$ MAX.				
T	Total tape thickness	$\frac{1.5}{(.059)}$ MAX.		$\frac{1.7}{(.067)}$ MAX.		$\frac{1.9}{(.075)}$ MAX.
t	Tape thickness	$\frac{0.9}{(.035)}$ MAX.				
P	Pitch of component	$\frac{12.7 \pm 1.0}{(.500 \pm .039)}$			$\frac{25.4 \pm 1.0}{(1.000 \pm .039)}$	
P ₀	Feed hole pitch	$\frac{12.7 \pm 0.3}{(.500 \pm .012)}$				
P ₁	Feed hole center to pitch	$\frac{3.85 \pm 0.7}{(.152 \pm .028)}$		$\frac{8.95 \pm 0.7}{(.352 \pm .028)}$		$\frac{7.7 \pm 0.7}{(.303 \pm .028)}$
R	Lead spacing	$\frac{5 + 0.5/-0.2}{(.197 + .020/- .008)}$		$\frac{7.5 + 0.5/-0.2}{(.295 + .020/- .008)}$		$\frac{10 + 0.5/-0.2}{(.394 + .020/- .008)}$
ΔP	Component alignment	$\frac{\pm 1.3}{(\pm .051)}$ MAX.				
Δh	Component alignment	$\frac{\pm 2}{(\pm .079)}$ MAX.				
d	Wire diameter	$\frac{0.6}{(.024)}$ MAX.		$\frac{0.8}{(.031)}$ MAX.		$\frac{1}{(.039)}$ MAX.
D ₀	Feed hold diameter	$\frac{4 \pm 0.2}{(.157 \pm .008)}$				
H	Height from tape center to component base	$\frac{18 + 2.0/-0.0}{(.709 + .079/- .000)}$				
H ₀	Seating plane height	$\frac{16 \pm 0.5}{(.630 \pm .020)}$				
H ₁	Component height	$\frac{32.2}{(1.268)}$ MAX.		$\frac{46.5}{(1.831)}$ MAX.		
L	Protrusion - cut out	$\frac{11}{(.433)}$ MAX.				
L ₁	Protrusion - cut off	$\frac{0.5}{(.020)}$ MAX.				

DIMENSIONS: $\frac{\text{MM}}{\text{(INCHES)}}$

Specifications are subject to change without notice.

Users should verify actual device performance in their specific applications.

The products described herein and this document are subject to specific legal disclaimers as set forth on the last page of this document, and at www.bourns.com/docs/legal/disclaimer.pdf.

CV Series - Medium Voltage Disc Varistors



Packaging Quantities - Bulk

Voltage	Model Size				
	5	7	10	14	20
50	1500	1500	600	400	300
60	1500	1500	600	400	300
75	1500	1500	600	400	300
95	1500	1000	600	400	300
115	1500	1000	500	400	300
130	1500	1000	500	400	300
140	1500	1000	500	400	300
150	1500	1000	500	400	300
175	1500	1000	500	400	300
230	1000	1000	500	300	300
250	1000	1000	500	300	200
275	1000	1000	500	300	200
300	1000	1000	500	300	200
320			500	300	200
385			400	300	200
420			400	300	200
460			400	300	200
510			400	300	200
550-680			300	300	200

Packaging Quantities - Reel

Voltage	Model Size				
	5	7	10	14	20
50	1500	1500	1300	700	
60	1500	1500	1300	700	
75	1500	1500	1300	700	
95	1500	1000	1300	600	
115	1300	1000	1000	600	
130	1300	1000	1000	600	
140	1200	1000	1000	600	
150	1200	1000	1000	600	
175	1200	1000	1000	500	
230	1000	1000	1000	500	
250	1000	1000	800	400	
275	1000	1000	800	400	
300	900	1000	800	400	
320			800	400	
385			700	400	
420			700	300	
460			600	300	
510			600	300	
550-680			600	300	

Specifications are subject to change without notice.

Users should verify actual device performance in their specific applications.

The products described herein and this document are subject to specific legal disclaimers as set forth on the last page of this document, and at www.bourns.com/docs/legal/disclaimer.pdf.

Assembly Recommendations for Through-Hole Components

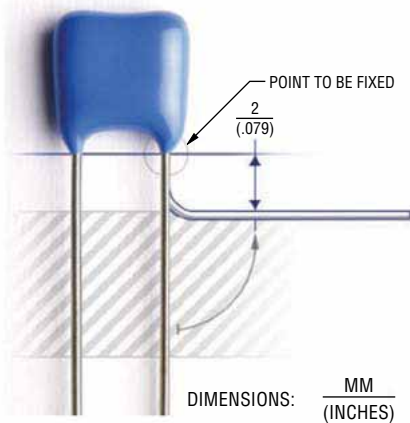

Very often before soldering through-hole components, their leads get bent. It is important not to damage the components during lead bending. Damage most commonly incurred during bending is cracks in epoxy parts, which can lead to increased humidity sensitivity of a component and, consequentially, a shorter lifetime.

In order to avoid epoxy damage, it is necessary to:

- fix the most sensitive point (epoxy parts) of a component body
- bend the wire at least 2 mm below the end of epoxy parts

Other potential damage to a component which can lead to component failure or a shorter lifetime is thermal shock during manual soldering with a soldering iron. This can occur when a soldering iron is placed too close to one point of the component body and it happens most often when the solder joint is too close to the varistor body.

Resistance to Soldering Heat

In the case of automatic wave soldering, it is important to provide sufficient resistance to soldering heat. In order to prevent any potential problems, internal standards were introduced for testing the resistance to soldering heat of through-hole components: 300 °C, 10 seconds.

Pb-free Wave Soldering Profile Recommendations

Recommended soldering profiles for all above components are in accordance with JEDEC standard curves (J-STD-020D) and are, therefore, compatible with the Pb-free process.

Lead-free Wave Soldering Profile - Pb-free wave profile requirements for soldering heat resistance of components

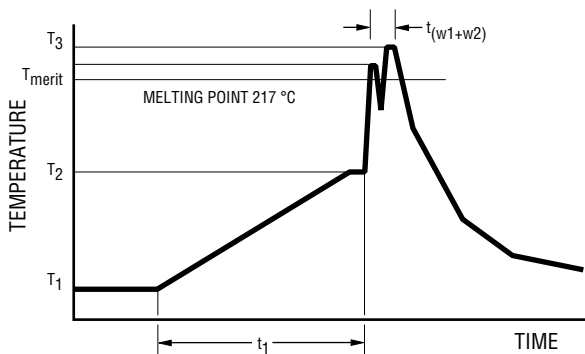

Parameter	Symbol	Specification
Preheating temperature gradient		4 °C/sec. max.
Preheating time	t_1	2 to 5 min.
Min. preheating temperature	T_1	130 °C
Max. preheating temperature	T_2	180 °C
Melting temperature/point	T_{meltv}	217 °C
Time in wave soldering phase (w_1+w_2)	t_{w1+w2}	10 sec.
Max. wave temperature (w_1+w_2)	T_s	265 °C +0/-5 °C
Cooling temperature gradient		6° C/sec. max.
Temperature jump from T_2 to T_3 (w_1)	$T_{3(w1)} - T_2$	120 °C max
Time from 25 °C to T_3 (wave temperature)		8 min. max.

Specifications are subject to change without notice.

Users should verify actual device performance in their specific applications.

The products described herein and this document are subject to specific legal disclaimers as set forth on the last page of this document, and at www.bourns.com/docs/legal/disclaimer.pdf.

Reliability Testing Procedures

Varistor test procedures comply with CECC 42200, IEC 1051-1/2 (and AEC-Q200, if applicable). Test results are available upon customer request. Special tests can be performed upon customer request.

Reliability Parameter	Test	Tested According to	Condition to be Satisfied after Testing
AC/DC Bias Reliability	AC/DC Life Test	CECC 42200, Test 4.20 or IEC 1051-1, Test 4.20, AEC-Q200 Test 8 - 1000 h at UCT	$ \delta V_N (1 \text{ mA}) < 10 \%$
Pulse Current Capability	$I_{\max} 8/20 \mu\text{s}$	CECC 42200, Test C 2.1 or IEC 1051-1, Test 4.5 10 pulses in the same direction at 2 pulses per minute at maximum peak current for 10 pulses	$ \delta V_N (1 \text{ mA}) < 10 \%$ no visible damage
Pulse Energy Capability	$W_{\max} 10/1000 \mu\text{s}$	CECC 42200, Test C 2.1 or IEC 1051-1, Test 4.5 10 pulses in the same direction at 1 pulse every 2 minutes at maximum peak current for 10 pulses	$ \delta V_N (1 \text{ mA}) < 10 \%$ no visible damage
WLD Capability	WLD x 10	ISO 7637, Test pulse 5, 10 pulses at rate of 1 per minute	$ \delta V_N (1 \text{ mA}) < 15 \%$ no visible damage
V_{jump} Capability	V _{jump} 5 min.	Increase of supply voltage to $V \geq V_{\text{jump}}$ for 1 minute	$ \delta V_N (1 \text{ mA}) < 15 \%$ no visible damage
Environmental and Storage Reliability	Climatic Sequence	CECC 42200, Test 4.16 or IEC 1051-1, Test 4.17 a) Dry heat, 16h, UCT, Test Ba, IEC 68-2-2 b) Damp heat, cyclic, the first cycle: 55 °C, 93 % RH, 24 h, Test Db 68-2-4 c) Cold, LCT, 2 h, Test Aa, IEC 68-2-1 d) Damp heat cyclic, remaining 5 cycles: 55 °C, 93 % RH, 24 h/cycle, Test Bd, IEC 68-2-30	$ \delta V_N (1 \text{ mA}) < 10 \%$
	Thermal Shock	CECC 42200, Test 4.12, Test Na, IEC 68-2-14, AEC-Q200 Test 16, 5	$ \delta V_N (1 \text{ mA}) < 10 \%$ no visible damage
	Steady State Damp Heat	CECC 42200, Test 4.17, Test Ca, IEC 68-2-3, AEC-Q200 Test 6, 56 days, 40 °C, 93 % RH, AEC-Q200 Test 7: Bias, Rh, T all at 85.	$ \delta V_N (1 \text{ mA}) < 10 \%$
	Storage Test	IEC 68-2-2, Test Ba, AEC-Q200 Test 3, 1000 h at maximum storage temperature	$ \delta V_N (1 \text{ mA}) < 5 \%$

Continued on Next Page

Reliability Testing Procedures (Continued)

Reliability Parameter	Test	Tested According to	Condition to be Satisfied after Testing
Mechanical Reliability	Solderability	CECC 42200, Test 4.10.1, Test Ta, IEC 68-2-20 solder bath and reflow method	Solderable at shipment and after 2 years of storage, criteria: >95% must be covered by solder for reflow meniscus
	Resistance to Soldering Heat	CECC 42200, Test 4.10.2, Test Tb, IEC 68-2-20 solder bath and reflow method	$ ΔV_{11}(1\text{ mA}) < 5\%$
	Terminal Strength	JIS-C-6429, App. 1, 18N for 60 sec. - same for AEC-Q200 Test 22	No visual damage
	Board Flex	JIS-C-6429, App. 2, 2 mm min. AEC-Q200 test 21 - Board flex: 2 mm flex min.	$ ΔV_{11}(1\text{ mA}) < 2\%$ No visible damage
	Vibration	CECC 42200, Test 4.15, Test Fc, IEC 68-2-6, AEC-Q200 Test 14 Frequency range 10 to 55 Hz (AEC: 10-2000 Hz) Amplitude 0.75 m/s ² or 98 m/s ² (AEC: 5 g for 20 minutes) Total duration 6 h (3x2 h) (AEC: 12 cycles each of 3 directions) Waveshape - half sine	$ ΔV_{11}(1\text{ mA}) < 2\%$ No visible damage
	Mechanical Shock	CECC 42200, Test 4.14, Test Ea, IEC 68-2-27, AEC-Q200 Test 13. Acceleration = 490 m/s ² (AEC: MIL-STD-202-Method 213), Pulse duration = 11 ms, Waveshape - half sine; Number of shocks = 3x6	$ ΔV_{11}(1\text{ mA}) < 10\%$ No visible damage
Electrical Transient Conduction	ISO-7637-1 Pulses	AEC-Q200 Test 30: Test pulses 1 to 3. Also other pulses - freestyle.	$ ΔV_{11}(1\text{ mA}) < 10\%$ No visible damage

Specifications are subject to change without notice.

Users should verify actual device performance in their specific applications.

The products described herein and this document are subject to specific legal disclaimers as set forth on the last page of this document, and at www.bourns.com/docs/legal/disclaimer.pdf.

Terminology

Term	Symbol	Definition
Rated AC Voltage	V_{rms}	Maximum continuous sinusoidal AC voltage (<5 % total harmonic distortion) which may be applied to the component under continuous operation conditions at +25 °C
Rated DC Voltage	V_{dc}	Maximum continuous DC voltage (<5 % ripple) which may be applied to the component under continuous operating conditions at +25 °C
Supply Voltage	V	The voltage by which the system is designated and to which certain operating characteristics of the system are referred; $V_{rms} = 1.1 \times V$
Leakage Current	I_{dc}	The current passing through the varistor at V_{dc} and at +25 °C or at any other specified temperature
Varistor Voltage	V_n	Voltage across the varistor measured at a given reference current (I_n)
Reference Current	I_n	Reference current = 1 mA DC
Clamping Voltage	V_c	The peak voltage developed across the varistor under standard atmospheric conditions, when passing an 8/20 μs class current pulse
Protection Level		
Class Current	I_c	A peak value of current which is 1/10 of the maximum peak current for 100 pulses at two per minute for the 8/20 μs pulse
Voltage Clamping Ratio	V_c/V_{app}	A figure of merit measure of the varistor clamping effectiveness as defined by the symbols V_c/V_{app} , where ($V_{app} = V_{rms}$ or V_{dc})
Jump Start Transient	V_{jump}	The jump start transient results from the temporary application of an overvoltage in excess of the rated battery voltage. The circuit power supply may be subjected to a temporary overvoltage condition due to the voltage regulation failing or it may be deliberately generated when it becomes necessary to boost start the car.
Rated Single Pulse	W_{max}	Energy which may be dissipated for a single 10/1000 μs pulse of a maximum rated current, with rated AC voltage or rated DC voltage also applied, without causing device failure
Transient Energy		
Load Dump Transient	WLD	Load Dump is a transient which occurs in automotive environments. It is an exponentially decaying positive voltage which occurs in the event of a battery disconnect while the alternator is still generating charging current with other loads remaining on the alternator circuit at the time of battery disconnect.
Rated Peak Single Pulse	I_{max}	Maximum peak current which may be applied for a single 8/20 μs pulse, with rated line voltage also applied, without causing device failure
Transient Current		
Rated Transient Average	P	Maximum average power which may be dissipated due to a group of pulses occurring within a specified isolated time period, without causing device failure at 25 °C
Power Dissipation		
Capacitance	C	Capacitance between two terminals of the varistor measured @ 1 kHz
Non-linearity Exponent	α	A measure of varistor nonlinearity between two given operating currents, I_n and I_1 as described by $I = k V \exp(a)$, where: - k is a device constant, - $I_1 < I < I_n$ and - $a \log(I_1/I_n) / \log(V_1/V_n) = 1 / \log(V_1/V_n)$, where: - I_r is reference current (1 mA) and V_n is varistor voltage - $I_1 = 10 I_n$, V_1 is the voltage measured at I_1
Response Time	t_r	The time lag between application of a surge and varistor's "turn-on" conduction action
Varistor Voltage Temperature	TC	$(V_n @ 85 \text{ °C} - V_n @ 25 \text{ °C}) / (V_n @ 25 \text{ °C}) \times 60 \text{ °C} \times 100$
Coefficient		
Insulation Resistance	IR	Minimum resistance between shorted terminals and varistor surface
Isolation Voltage		The maximum peak voltage which may be applied under continuous operating conditions between the varistor terminations and any conducting mounting surface
Operating Temperature		The range of ambient temperature for which the varistor is designed to operate continuously as defined by the temperature limits of its climatic category
Climatic Category	LCT/UCT/DHD	LCT & UCT = Lower and Upper Category Temperature - the minimum and maximum ambient temperatures for which a varistor has been designed to operate continuously. DHD = Dump Heat Test Duration
Storage Temperature		Storage temperature range without voltage applied
Current/Energy Derating		Derating of maximum values when operated above UCT

REV. E 06/20

Specifications are subject to change without notice.

Users should verify actual device performance in their specific applications.

The products described herein and this document are subject to specific legal disclaimers as set forth on the last page of this document, and at www.bourns.com/docs/legal/disclaimer.pdf.