

# SERPAC CXL6 1D-YY-A-ZZ

Electronic Enclosures

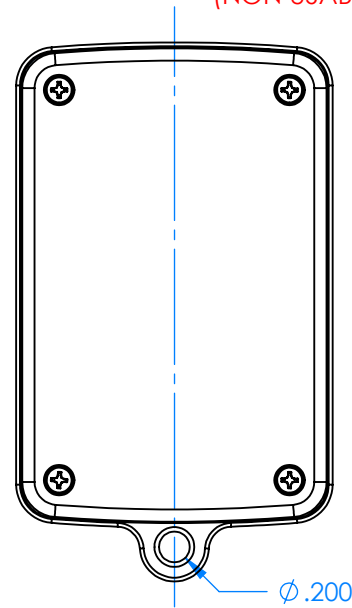

.035 TYP. PCB CLAMP AREA (NON USABLE MARGIN)

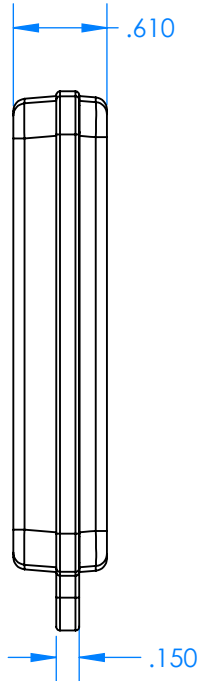
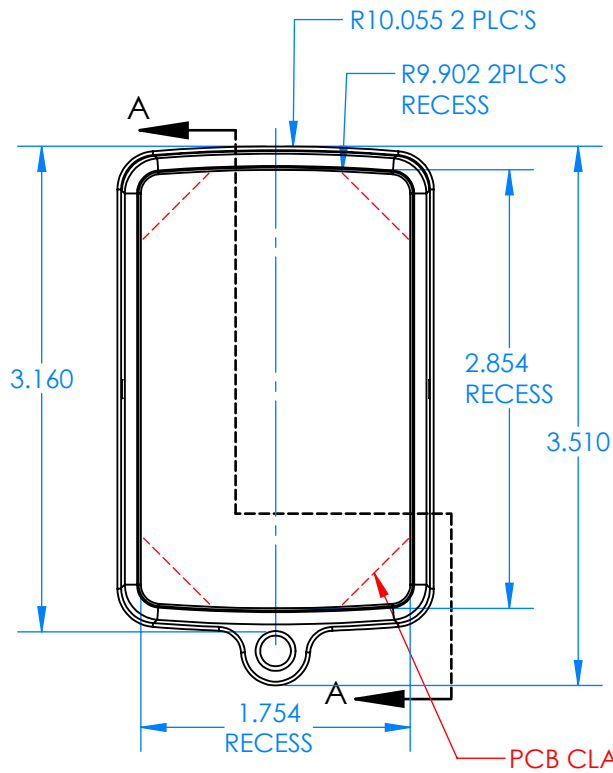
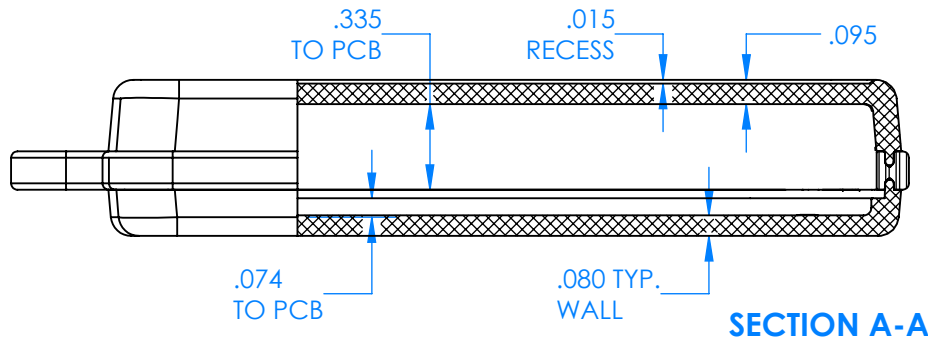
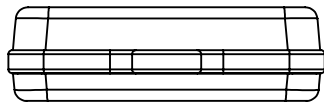
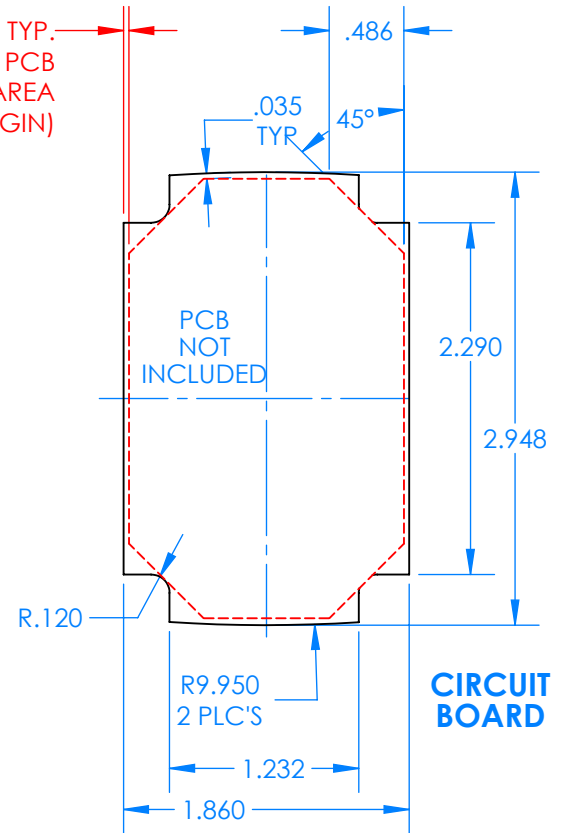

**Enclosure color (YY)**  
**Top-Bottom combinations available**  
 BK=black  
 CL=clear  
 TRGY=translucent gray  
 TRRD=translucent red

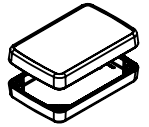

**Seal color (ZZ)**  
 BK=black  
 BL=blue  
 GM=gunmetal  
 NG=neon green  
 NO=neon orange  
 OR=orange  
 YL=yellow  
 WH=white

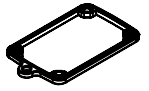

PN	Description
5533D	(1) BW 6B Top style D
5532D	(1) BW 6A Bottom style D
5541A	(1) CXL6A Series perimeter seal style A
6002	(4) #2 X 3/8" PH HD screw TORQUE 35-60 in-oz.

**Wateright enclosure mees or exceeds:**  
**IP67**  
**NEMA 4X, 12, 13**