

SERPAC CXL6 1D-YY-A-ZZ

Electronic Enclosures

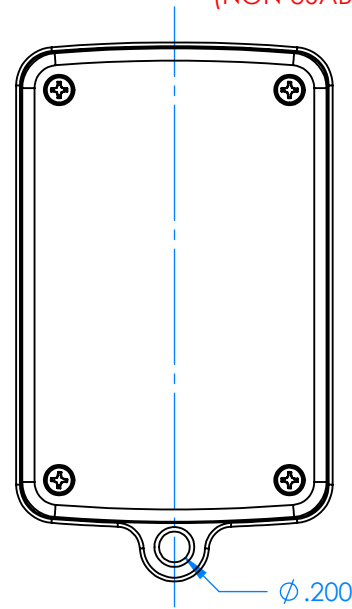

.035 TYP. PCB CLAMP AREA (NON USABLE MARGIN)

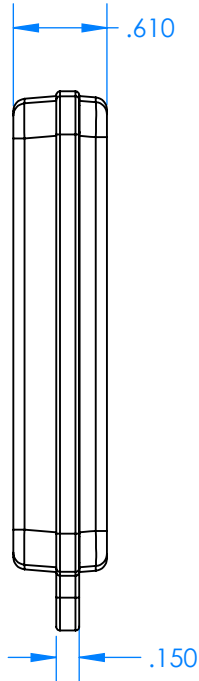
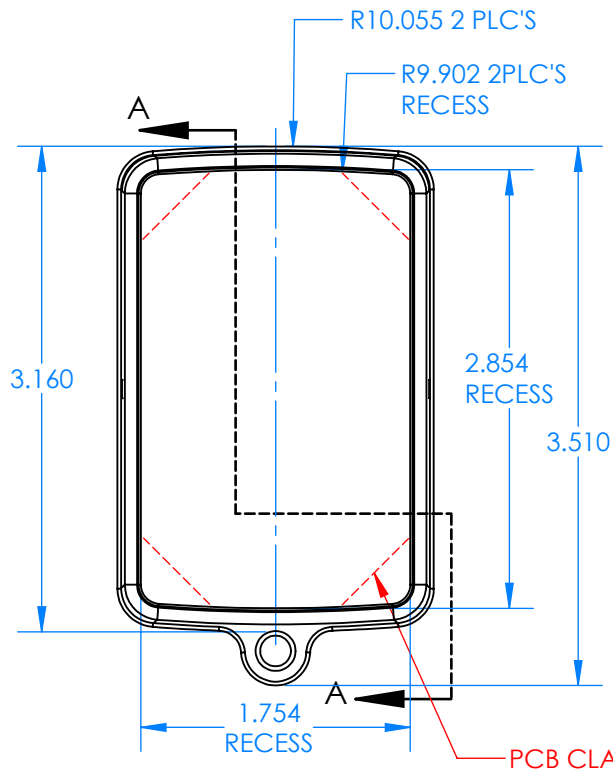
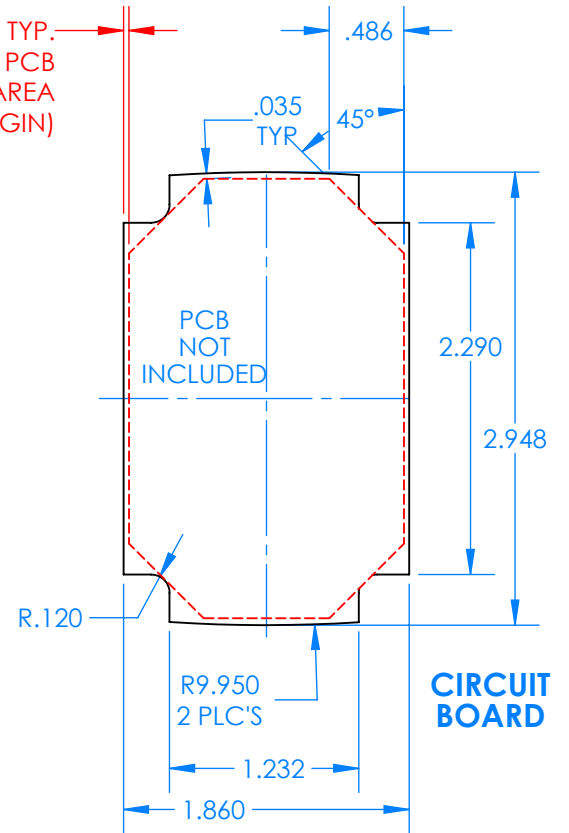

CIRCUIT BOARD

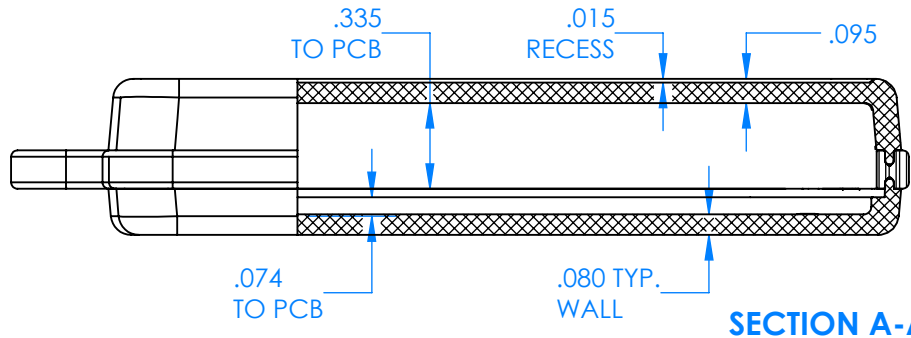
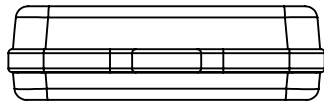

Enclosure color (YY)

Top-Bottom combinations available

- BK=black
- CL=clear
- TRGY=translucent gray
- TRRD=translucent red

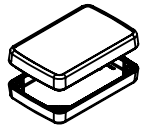

Seal color (ZZ)

- BK=black
- BL=blue
- GM=gunmetal
- NG=neon green
- NO=neon orange
- OR=orange
- YL=yellow
- WH=white

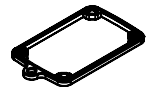

PN	Description
5533D	(1) BW 6B Top style D
5532D	(1) BW 6A Bottom style D
5541A	(1) CXL6A Series perimeter seal style A
6002	(4) #2 X 3/8" PH HD screw TORQUE 35-60 in-oz.

Wateright enclosure meets or exceeds:
IP67
NEMA 4X, 12, 13