

# Four Output PCI-X and General Purpose Buffer

## Features

- One input to four output buffer/driver
- General-purpose or PCI-X clock buffer
- Buffers all frequencies from DC to 140 MHz
- Output-to-output skew less than 100 ps
- Space-saving 8-pin TSSOP package
- 3.3 V operation
- 60 ps typical output-output skew

## Functional Description

The CY2304NZ is a low-cost buffer designed to distribute high-speed clocks for PCI-X and other applications. The device operates at 3.3 V and outputs can run up to 140 MHz.

For a complete list of related documentation, click [here](#).

## Function Table

Inputs		Outputs
BUF_IN	OE	Output [1:4]
L	L	L
H	L	L
L	H	L
H	H	H

## Block Diagram

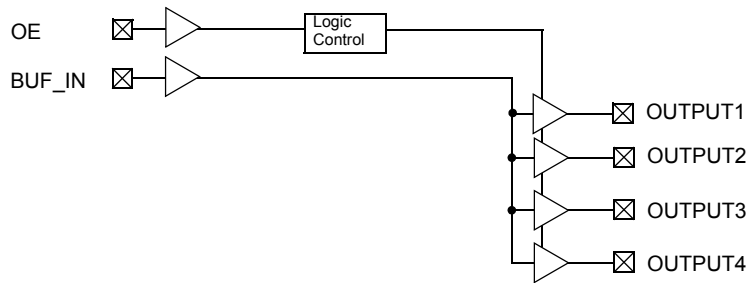

## Pin Configuration

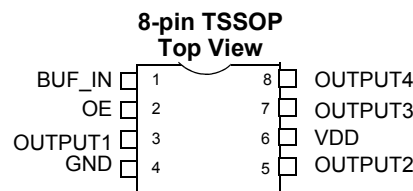

## Pin Description

For CY2304NZ

Signal	Pin	Description
V <sub>DD</sub>	6	3.3 V voltage supply
GND	4	Ground
BUF_IN	1	Input clock
OUTPUT [1:4]	3, 5, 7, 8	Outputs
OE	2	Input pin for output enable, active HIGH.

## Maximum Ratings

Supply Voltage to Ground Potential .... -0.5 V to  $V_{DD} + 0.5$  V  
 DC Input Voltage ..... -0.5 V to  $V_{DD} + 0.5$  V

Storage Temperature ..... -65 °C to +150 °C  
 Max. Soldering Temperature (10 sec.) ..... 260 °C  
 Junction Temperature ..... 150 °C

## Operating Conditions

Parameter	Description	Min	Max	Unit
$V_{DD}$	Supply Voltage	3.0	3.6	V
$T_A$	Operating Temperature (Ambient Temperature)	-40	85	°C
$C_L$	Load Capacitance	-	25	pF
$C_{IN}$	Input Capacitance	-	7	pF
BUF_IN, OUTPUT [1:4]	Operating Frequency	DC	140	MHz
$t_{PU}^{[1]}$	Power-up time for all VDD's to reach minimum specified voltage (power ramps must be monotonic)	0.05	50	ms

## Electrical Characteristics

Parameter	Description	Test Conditions	Min	Max	Unit
$V_{IL}$	Input LOW Voltage <sup>[2]</sup>		-	0.8	V
$V_{IH}$	Input HIGH Voltage <sup>[2]</sup>		2.0	-	V
$I_{IL}$	Input LOW Current	$V_{IN} = 0$ V	-5	5	μA
$I_{IH}$	Input HIGH Current	$V_{IN} = V_{DD}$	-5	5	μA
$V_{OL}$	Output LOW Voltage <sup>[3]</sup>	$I_{OL} = 24$ mA	-	0.8	V
		$I_{OL} = 12$ mA	-	0.55	V
$V_{OH}$	Output HIGH Voltage <sup>[3]</sup>	$I_{OH} = -24$ mA	2.0	-	V
		$I_{OH} = -12$ mA	2.4	-	V
$I_{DD}$	Supply Current	Unloaded outputs at 66.66 MHz	-	25	mA

## Thermal Resistance

Parameter <sup>[4]</sup>	Description	Test Conditions	8-pin TSSOP	Unit
$\theta_{JA}$	Thermal resistance (junction to ambient)	Test conditions follow standard test methods and procedures for measuring thermal impedance, in accordance with EIA/JESD51.	165	°C/W
$\theta_{JC}$	Thermal resistance (junction to case)		33	°C/W

### Notes

1. This operating condition guarantees skew and propagation delay.
2. BUF\_IN input has a threshold voltage of  $V_{DD}/2$ .
3. Parameter is guaranteed by design and characterization. It is not 100% tested in production.
4. These parameters are guaranteed by design and are not tested.

## Switching Characteristics

For Commercial and Industrial Temperature Devices which are characterized over the frequency range of 1 MHz to 140 MHz.

Parameter <sup>[5]</sup>	Name	Description	Min	Typ	Max	Unit
	Duty Cycle <sup>[6]</sup> = $t_2 \div t_1$	Measured at 1.5 V	40.0	50.0	60.0	%
$t_3$	Rise Time <sup>[6]</sup>	Measured between 0.8 V and 2.0 V	–	–	1.50	ns
$t_4$	Fall Time <sup>[6]</sup>	Measured between 0.8 V and 2.0 V	–	–	1.50	ns
$t_5$	Output to Output Skew <sup>[6]</sup>	All outputs equally loaded	–	60	100	ps
$t_6$	Propagation Delay, BUF_IN Rising Edge to OUTPUT Rising Edge <sup>[6]</sup>	Measured at $V_{DD}/2$	2.5	3.5	5	ns

## Switching Waveforms

Figure 1. Duty Cycle Timing

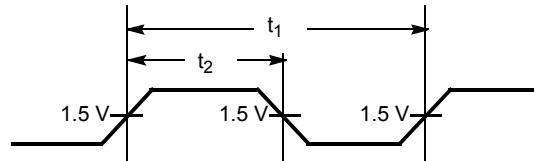

Figure 2. All Outputs Rise/Fall Time

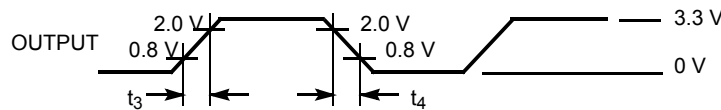

Figure 3. Output-Output Skew

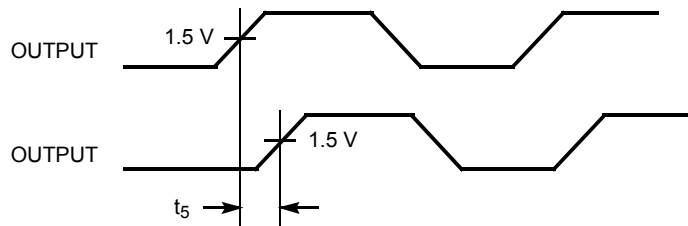
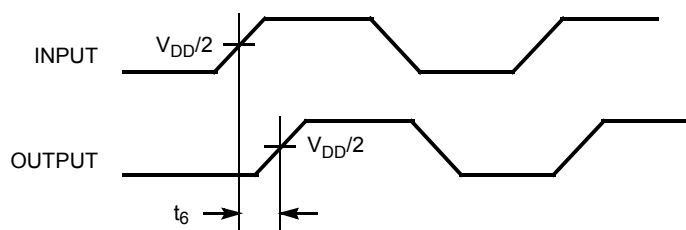

Figure 4. Input-Output Propagation Delay



**Notes**

- 5. All parameters specified with loaded outputs.
- 6. Parameter is guaranteed by design and characterization. It is not 100% tested in production.

### Ordering Information

Ordering Code	Package Type	Operating Range
<b>Standard</b>		
CY2304NZZI-1	8-pin TSSOP	Industrial, -40 °C to 85 °C
CY2304NZZI-1T	8-pin TSSOP – Tape and Reel	Industrial, -40 °C to 85 °C
<b>Pb-free</b>		
CY2304NZZXC-1	8-pin TSSOP	Commercial, 0 °C to 70 °C
CY2304NZZXC-1T	8-pin TSSOP – Tape and Reel	Commercial, 0 °C to 70 °C
CY2304NZZXI-1	8-pin TSSOP	Industrial, -40 °C to 85 °C
CY2304NZZXI-1T	8-pin TSSOP – Tape and Reel	Industrial, -40 °C to 85 °C

### Ordering Code Definitions

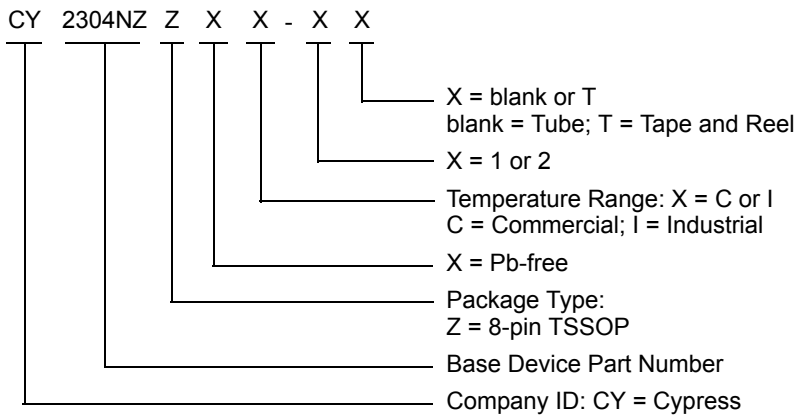

Package Diagram

Figure 5. 8-pin TSSOP (4.40 mm Body) Z08.173/ZZ08.173 Package Outline, 51-85093

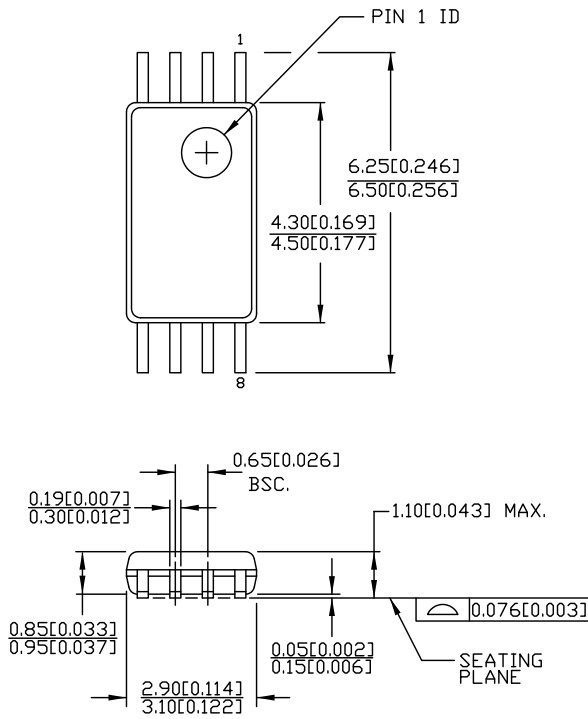

DIMENSIONS IN MM [INCHES] MIN. MAX.

REFERENCE JEDEC MO-153

PART #	
Z08.173	STANDARD PKG.
ZZ08.173	LEAD FREE PKG.

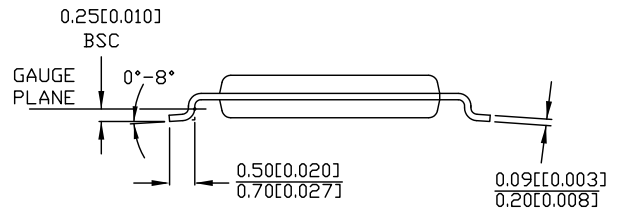

51-85093 \*E

## Acronyms

Acronym	Description
PCI	Peripheral Component Interconnect
TSSOP	Thin-Shrink Small Outline Package

## Document Conventions

### Units of Measure

Symbol	Unit of Measure
°C	degree Celsius
Hz	hertz
MHz	megahertz
μA	microampere
mA	milliampere
ms	millisecond
mV	millivolt
ns	nanosecond
Ω	ohm
%	percent
pF	picofarad
ps	picosecond
V	volt
W	watt

Document History Page

Document Title: CY2304NZ, Four Output PCI-X and General Purpose Buffer				
Document Number: 38-07099				
Rev.	ECN No.	Issue Date	Orig. of Change	Description of Change
**	111420	02/12/02	IKA	New data sheet.
*A	118610	09/25/02	HWT	Updated <a href="#">Ordering Information</a> : Added Industrial Temperature Range in the Ordering Information.
*B	121820	12/14/02	RBI	Updated <a href="#">Operating Conditions</a> : Added t <sub>PJ</sub> parameter and its details.
*C	291098	See ECN	RGL	Updated <a href="#">Switching Characteristics</a> : Specified typical value for "Output to Output Skew" parameter. Updated <a href="#">Ordering Information</a> : Added Lead-free Devices.
*D	2904623	04/05/10	CXQ	Updated <a href="#">Ordering Information</a> (Removed inactive parts). Updated <a href="#">Package Diagram</a> .
*E	3163624	02/05/2011	CXQ	Updated <a href="#">Maximum Ratings</a> (Removed reference to "Except REF" and "REF" for DC Input Voltage spec). Added <a href="#">Ordering Code Definitions</a> . Updated <a href="#">Package Diagram</a> . Added <a href="#">Acronyms</a> and <a href="#">Units of Measure</a> . Updated to new template.
*F	3931498	04/08/2013	PURU	Updated <a href="#">Maximum Ratings</a> : Removed "Static Discharge Voltage" and its related information. Updated <a href="#">Package Diagram</a> : spec 51-85093 – Changed revision from *C to *D.
*G	4103402	08/23/2013	MNSB	Updated <a href="#">Operating Conditions</a> : Added Note 1 and referred the same note in t <sub>PJ</sub> parameter. Updated to new template.
*H	4312848	03/18/2014	CINM	No technical updates. Completing Sunset Review.
*I	4578443	11/25/2014	AJU	Updated <a href="#">Functional Description</a> : Added "For a complete list of related documentation, click <a href="#">here</a> ." at the end. Updated <a href="#">Package Diagram</a> : spec 51-85093 – Changed revision from *D to *E.
*J	4756553	05/06/2015	TAVA	Updated <a href="#">Switching Characteristics</a> : Replaced "For Commercial and Industrial Temperature Devices" with "For Commercial and Industrial Temperature Devices which are characterized over the frequency range of 1 MHz to 140 MHz." for characterization.
*K	5258800	05/04/2016	PSR	Added <a href="#">Thermal Resistance</a> . Updated to new template.