

EZ-USB HX2LP™

Low Power USB 2.0 Hub Controller Family

Features

- USB 2.0 hub controller
- Automotive and Industrial grade option (−40 °C to 85 °C)
- Compliant with USB 2.0 specification
- USB-IF certified: TID# 30000009
- Windows Hardware Quality Lab (WHQL) Compliant
- Up to four downstream ports supported
- Supports bus powered and self powered modes
- Single transaction translator (TT)
- Bus power configurations
- Fit, form, and function compatible with CY7C65640 and CY7C65640A (TetraHub™)
- Space saving 56-pin QFN
- Single power supply requirement
 - Internal regulator for reduced cost
- Integrated upstream pull-up resistor
- Integrated pull-down resistors for all downstream ports
- Integrated upstream and downstream termination resistors
- Integrated port status indicator control
- 24 MHz external crystal (integrated phase-locked loop (PLL))
- In-system EEPROM programming
- Configurable with external SPI EEPROM:
 - Vendor ID, Product ID, Device ID (VID/PID/DID)
 - Number of active ports
 - Number of removable ports
 - Maximum power setting for high-speed and full-speed
 - Hub controller power setting
 - Power-on timer
 - Overcurrent detection mode
 - Enabled and disabled overcurrent timer
 - Overcurrent pin polarity
 - Indicator pin polarity
 - Compound device
 - Enable full-speed only
 - Disable port indicators
 - Ganged power switching
 - Self and bus powered compatibility
 - Fully configurable string descriptors for multiple language support

For a complete list of related documentation, click [here](#).

Block Diagram – CY7C65630

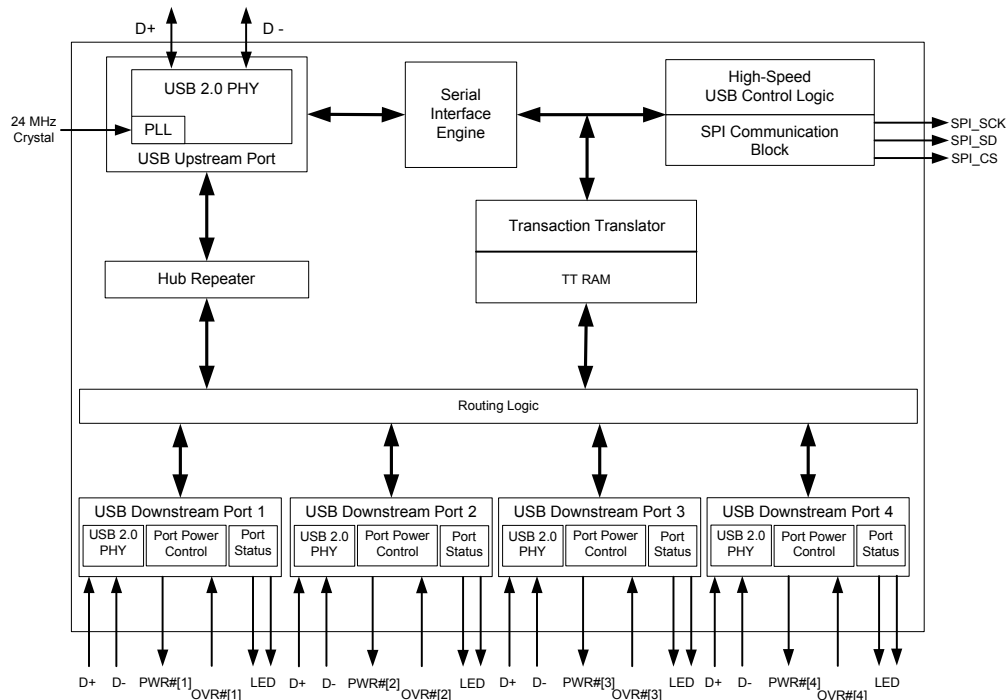

Errata: For information on silicon errata, see "Errata" on page 28. Details include trigger conditions, devices affected, and proposed workaround.

Block Diagram – CY7C65620

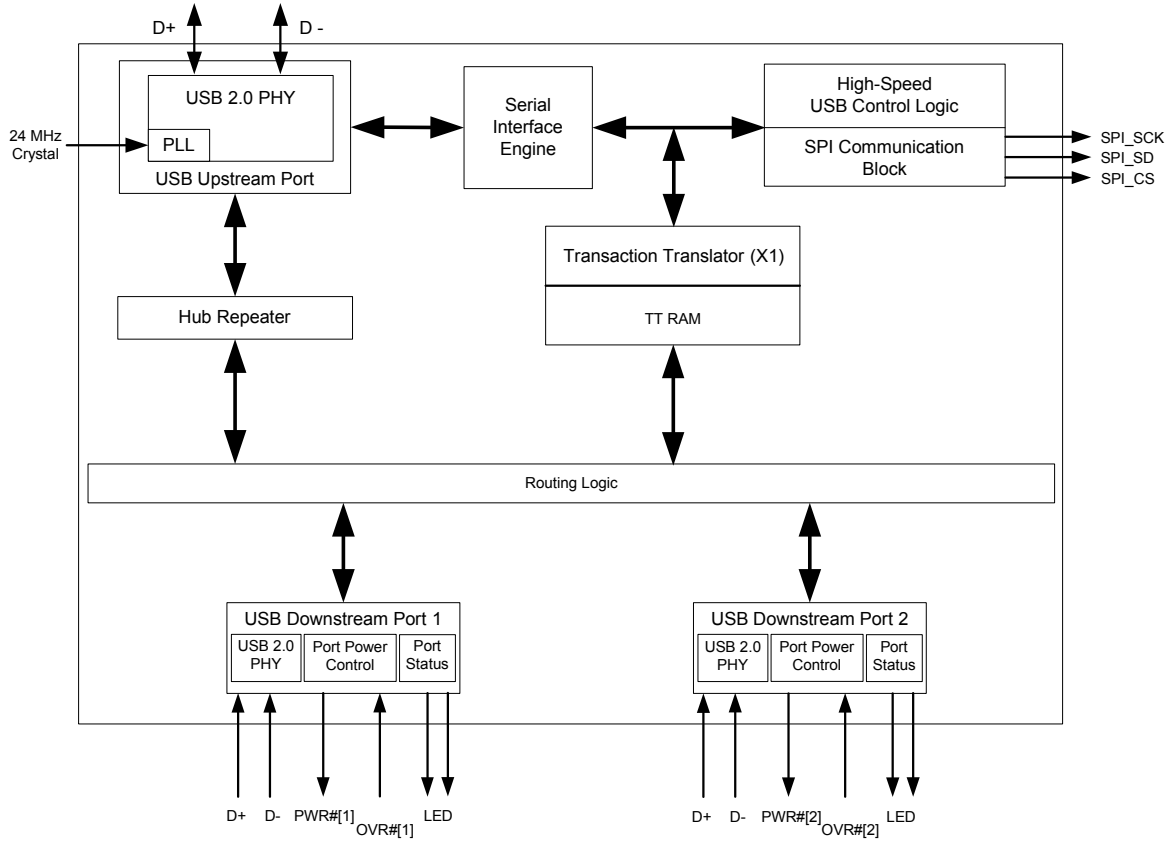

More Information

Cypress provides a wealth of data at www.cypress.com to help you to select the right <product> device for your design, and to help you to quickly and effectively integrate the device into your design. For a comprehensive list of resources, see the knowledge base article <http://www.cypress.com/products/hx2lp>.

- Overview: [USB Portfolio](#), [USB Roadmap](#)
- USB 2.0 Product Selectors: [HX2LP](#), [HX2VL](#)
- Application notes: Cypress offers a large number of USB application notes covering a broad range of topics, from basic to advanced level. Recommended application notes for getting started with HX2LP are:
 - [AN49150 - Schematic and Layout Review Checklist for HX2LP](#)
 - [AN5044 - EZ-USB Hubs\(CY7C656XX\) PCB Design Recommendations](#)
 - [AN15454 - Bus-Powered USB Hub Design Using EZ-USB HX2LP™/HX2VL](#)
 - [AN61904 - How HX2LP™ Addresses Byte and Word-Addressable SPI EEPROMs](#)
 - [AN69235 - Migrating from HX2/HX2LP to HX2VL](#)
 - [AN5038 - Migrating From EZ-USB® HX2™ to EZ-USB HX2LP™](#)
- Reference Designs:
 - [CY4605 - High-Speed Low-Power USB 2.0 Compliant 2-Port Hub](#)
 - [CY4606 - EZ-USB HX2LP High-Speed Low-Power USB 2.0 Compliant 4-Port Hub](#)
- Models: [HX2LP](#)

EZ-USB® HX2LP™ Reference Design Kit (RDK)

EZ-USB® HX2LP™ Reference Design Kit (RDK) board is a tool to demonstrate the features of EZ-USB HX2LP devices (CY7C65620/CY7C65630). Both CY7C65620 and CY7C65630 are identical in every aspect except for the number of ports they support. The HX2LP RDK is based on the 56-pin QFN for CY7C65620/CY7C65630. Both are single transaction translator (1TT) hubs. In the initial phase of the design, this board helps developers to understand the chip features and limitations before proceeding with a complete design. The RDK includes support documents related to board hardware, PC application software, and EEPROM configuration data (.iic) files.

Contents

Introduction	5	Upstream USB Connection	21
USB Serial Interface Engine	5	Downstream USB Connection	21
Hub Repeater	5	LED Connection	21
Transaction Translator	5	System Block Diagram	22
Applications	5	Absolute Maximum Ratings	23
Functional Overview	5	Operating Conditions	23
System Initialization	5	Electrical Characteristics	23
Enumeration	5	DC Electrical Characteristics	23
Downstream Ports	6	USB Transceiver	23
Upstream Port	6	AC Electrical Characteristics	24
Power Switching	6	Ordering Information	25
Overcurrent Detection	6	Ordering Code Definitions	25
Port Indicators	6	Package Diagrams	26
Pin Configuration	8	Thermal Impedance for the Package	26
Pin Definitions	9	Acronyms	27
Default Descriptors	11	Document Conventions	27
Device Descriptor	11	Units of Measure	27
Configuration Descriptor	11	Numeric Naming	27
Interface Descriptor	12	Errata	28
Endpoint Descriptor	12	Part Numbers Affected	28
Device Qualifier Descriptor	12	HX2LP Qualification Status	28
Hub Descriptor	13	HX2LP Errata Summary	28
Configuration Options	14	Document History Page	29
0xD0 Load	14	Sales, Solutions, and Legal Information	32
0xD2 Load	14	Worldwide Sales and Design Support	32
0xD4 Load	15	Products	32
Supported USB Requests	18	PSoC® Solutions	32
Device Class Commands	18	Cypress Developer Community	32
Hub Class Commands	19	Technical Support	32

Introduction

EZ-USB HX2LP™ is Cypress's next generation family of high-performance, low-power USB 2.0 hub controllers. HX2LP is an ultra low power single chip USB 2.0 hub controller with integrated upstream and downstream transceivers, a USB serial interface engine (SIE), USB hub control and repeater logic, and TT logic. Cypress has also integrated many of the external passive components, such as pull-up and pull-down resistors, reducing the overall bill of materials required to implement a hub design. The HX2LP portfolio consists of:

- **CY7C65630: 4-port/single transaction translator**

This device option is for ultra low-power applications that require four downstream ports. All four ports share a single transaction translator. The CY7C65630 is available in 56 QFN and is also pin-for-pin compatible with the CY7C65640.

- **CY7C65620: 2-port/single transaction translator**

This device option is for a 2-port bus powered application. Both ports share a single transaction translator. The CY7C65620 is available in a 56 QFN.

All device options are supported by Cypress's world class reference design kits, which include board schematics, bill of materials, Gerber files, Orcad files, and thorough design documentation.

USB Serial Interface Engine

The serial interface engine (SIE) allows the CY7C65620/CY7C65630 to communicate with the USB host. The SIE handles the following USB activities independently of the Hub Control Block.

- Bit stuffing and unstuffing
- Checksum generation and checking
- TOKEN type identification
- Address checking.

Hub Repeater

The hub repeater manages the connectivity between upstream and downstream facing ports that are operating at the same speed. It supports full- or low-speed connectivity and high-speed connectivity. According to the USB 2.0 specification, the HUB Repeater provides the following functions:

- Sets up and tears down connectivity on packet boundaries
- Ensures orderly entry into and out of the suspend state, including proper handling of remote wakeups.

Transaction Translator

The TT translates data from one speed to another. A TT takes high speed split transactions and translates them to full- or low-speed transactions when the hub is operating at high-speed (the upstream port is connected to a high-speed host controller) and has full- or low-speed devices attached. The operating speed of a device attached on a downstream facing port determines whether the routing logic connects a port to the TT or hub repeater. If a full- or low-speed device is connected to the hub operating at high-speed, the data transfer route includes the TT. If a high-speed device is connected to this high-speed hub,

the route only includes the repeater and no TT, because the device and the hub are operating at the same speed. When the hub is operating at full-speed (the upstream port is connected to a full-speed host controller), a high-speed peripheral does not operate at its full capability. These devices only work at full-speed. Full- and low-speed devices connected to this hub operate at their normal speed.

Applications

Typical applications for the HX2LP device family are:

- Standalone hubs
- Motherboard hubs
- Monitor hubs
- Advanced port replicators
- Docking stations
- Split-PC designs
- External personal storage drives
- Keyboard hubs

Functional Overview

The Cypress CY7C65620/CY7C65630 USB 2.0 Hubs are high-performance, low system cost solutions for USB. The CY7C65620/CY7C65630 USB 2.0 Hubs integrate 1.5 k Ω upstream pull-up resistors for full-speed operation and all downstream 15 k Ω pull-down resistors and series termination resistors on all upstream and downstream D+ and D- pins. This results in optimization of system costs by providing built-in support for the USB 2.0 specification.

System Initialization

On power-up, the CY7C65620/CY7C65630 reads an external SPI EEPROM for configuration information. At the most basic level, this EEPROM has the vendor ID (VID), product ID (PID), and device ID (DID) for the customer's application. For more specialized applications, other configuration options can be specified. See [Configuration Options on page 14](#) for more details.

After reading the EEPROM, if VBUSPOWER (connected to upstream V_{BUS}) is high, CY7C65620/CY7C65630 enables the pull-up resistor on D+ to indicate its presence to the upstream hub, after which a USB bus reset is expected. During this reset, CY7C65620/CY7C65630 initiates a chirp to indicate that it is a high-speed peripheral. In a USB 2.0 system, the upstream hub responds with a chirp sequence, and CY7C65620/CY7C65630 is in a high-speed mode, with the upstream D+ pull-up resistor turned off. In USB 1.x systems, no such chirp sequence from the upstream hub is seen, and CY7C65620/CY7C65630 operates as a normal 1.x hub (operating at full-speed).

Enumeration

After a USB bus reset, CY7C65620/CY7C65630 is in an unaddressed, unconfigured state (configuration value set to '0'). During the enumeration process, the host sets the hub's address and configuration. After the hub is configured, the full hub functionality is available.

Downstream Ports

The CY7C65620/CY7C65630 supports a maximum of four downstream ports, each of which may be marked as usable or removable in the extended configuration (0xD2 EEPROM load or 0xD4 EEPROM load, see [Configuration Options on page 14](#). Downstream D+ and D– pull-down resistors are incorporated in CY7C65620/CY7C65630 for each port. Before the hubs are configured, the ports are driven SE0 (single ended zero, where both D+ and D– are driven low) and are set to the unpowered state. When the hub is configured, the ports are not driven and the host may power the ports by sending a SetPortPower command for each port. After a port is powered, any connect or disconnect event is detected by the hub. Any change in the port state is reported by the hubs back to the host through the status change endpoint (endpoint 1). On receipt of SetPortReset request for a port with a device connected, the hub does as follows:

- Performs a USB reset on the corresponding port
- Puts the port in an enabled state
- Enables the green port indicator for that port (if not previously overridden by the host)
- Enables babble detection after the port is enabled.

Babble consists of a non-idle condition on the port after EOF2. If babble is detected on an enabled port, that port is disabled. A ClearPortEnable request from the host also disables the specified port.

Downstream ports can be individually suspended by the host with the SetPortSuspend request. If the hub is not suspended, a remote wakeup event on that port is reflected to the host through a port change indication in the hub status change endpoint. If the hub is suspended, a remote wakeup event on this port is forwarded to the host. The host may resume the port by sending a ClearPortSuspend command.

Upstream Port

The upstream port includes the transmitter and the receiver state machine. The transmitter and receiver operate in high-speed and full-speed depending on the current hub configuration.

The transmitter state machine monitors the upstream facing port while the hub repeater has connectivity in the upstream direction. This machine prevents babble and disconnect events on the downstream facing ports of this hub from propagating and causing the hub to be disabled or disconnected by the hub to which it is attached.

Power Switching

The CY7C65620/CY7C65630 includes interface signals for external port power switches. Both ganged and individual (per-port) configurations are supported, with individual switching being the default. Initially all ports are unpowered. After enumerating, the host may power each port by sending a SetPortPower request for that port. The power switching and overcurrent detection of downstream ports is managed by control pins connected to an external power switch device. PWR

[n]# output pins of the CY7C65620/CY7C65630 series are connected to the respective external power switch's port power enable signals. Note that each port power output pin of the external power switch must be bypassed with an electrolytic or tantalum capacitor as required by the USB specification. These capacitors supply the inrush currents, which occur during downstream device hot-attach events. The polarity of this pin is configured through the EEPROM; see [Configuration Options on page 14](#).

Overcurrent Detection

Overcurrent detection includes 8 ms of timed filtering by default. This parameter is configured from the external EEPROM in a range of 0 ms to 15 ms for both enabled ports and disabled ports individually. Detection of overcurrent on downstream ports is managed by control pins connected to an external power switch device.

The OVR[n]# pins of the CY7C65620/CY7C65630 series are connected to the respective external power switch's port overcurrent indication (output) signals. After detecting an overcurrent condition, hub reports overcurrent condition to the host and disables the PWR# output to the external power device. The polarity of the OVR pins can be configured through the EEPROM; see [Configuration Options on page 14](#).

Port Indicators

The USB 2.0 port indicators are also supported directly by CY7C65620/CY7C65630. According to the specification, each downstream port of the hub optionally supports a status indicator. The presence of indicators for downstream facing ports is specified by bit 7 of the wHubCharacteristics field of the hub class descriptor. The default CY7C65620/CY7C65630 descriptor specifies that port indicators are supported (wHubCharacteristics, bit 7 is set). If port indicators are not included in the hub, disable this bit through EEPROM settings.

Each port indicator pin is strategically located directly on the opposite edge of the port with which it is associated. A port indicator provides two colors: green and amber. This is usually implemented as two separate LEDs, one amber and the other green. A combination of hardware and software control is used to inform the user of the current status of the port or the device attached to the port and to guide the user through problem resolution. Colors and blinking provide information to the user. The significance of the color of the LED depends on the operational mode of CY7C65620/CY7C65630. The CY7C65620/CY7C65630 port indicators has two modes of operation: automatic and manual.

On power up the CY7C65620/CY7C65630 defaults to automatic mode, where the color of the Port Indicator (green, amber, off) indicates the functional status of the CY7C65620/CY7C65630 port. In automatic mode, the CY7C65620/CY7C65630 turns on the green LED whenever the port is enabled and the amber LED when an overcurrent condition is detected. The color of the port indicator is set by the port state machine. Blinking of the LEDs is not supported in automatic mode. [Table 1](#) identifies the mapping of color to port state in automatic mode.

Table 1. Automatic Port State to Port Indicator Color Mapping

Downstream Facing Hub Port State	
Color Definition	Port State
Off or Amber, if due to an overcurrent condition	Powered Off
Off	Disconnected, Disabled, Not Configured, Resetting, Testing
Green	Enabled, Transmit, or TransmitR
Off	Suspended, Resuming, SendEOR, Restart_E/S

The LED control lines can also be modulated with a square wave for power conservation. The polarity of these pins is programmable, see [Configuration Options on page 14](#).

In manual mode, the indicators are under the control of the host, which can turn on the LEDs, or leave them off. This is done by a USB Hub class request. Blinking of the LEDs is supported in manual mode. The port indicators enable the user to intervene in any error detection. For example, when babble is detected while plugging in a defective device, or when an overcurrent condition occurs, the port indicators corresponding to the downstream port blink green or only light the amber LED, respectively.

[Table 2](#) displays the color definition of the indicators when CY7C65620/CY7C65630 is in manual mode.^[1]

Table 2. Port Indicator Color Definitions in Manual Mode

Color Definition	Port State
Off	Not operational
Amber	Error condition
Green	Fully operational
Blinking Off / Green	Software attention
Blinking Off / Amber	Hardware attention
Blinking Green / Amber	Reserved

Note

1. Information presented in [Table 1](#) and [Table 2](#) is from USB 2.0 specification Tables 11-6 and 11-7, respectively.

Pin Configuration

Figure 1. 56-pin Quad Flat Pack No Leads (8 mm × 8 mm) [2]

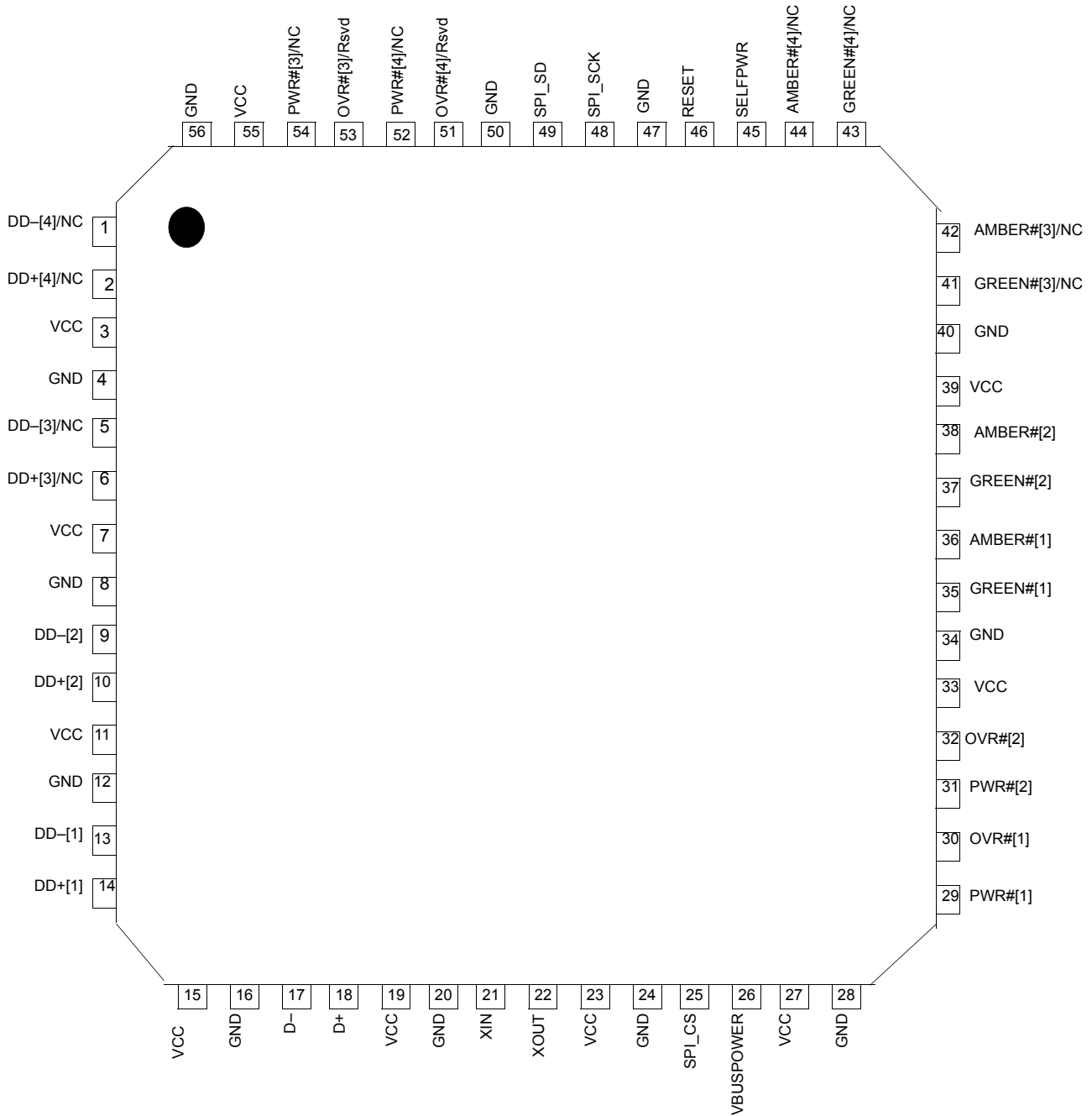

Note

2. NC and Rsvd are for CY7C65620 only.

Pin Definitions

Table 3. Pin Assignments^[3]

Pin	CY7C65630 Name	CY7C65620 Name	Type	Default	Description
3	V _{CC}	V _{CC}	Power	N/A	V _{CC} . This signal provides power to the chip.
7	V _{CC}	V _{CC}	Power	N/A	V _{CC} . This signal provides power to the chip.
11	V _{CC}	V _{CC}	Power	N/A	V _{CC} . This signal provides power to the chip.
15	V _{CC}	V _{CC}	Power	N/A	V _{CC} . This signal provides power to the chip.
19	V _{CC}	V _{CC}	Power	N/A	V _{CC} . This signal provides power to the chip.
23	V _{CC}	V _{CC}	Power	N/A	V _{CC} . This signal provides power to the chip.
27	V _{CC}	V _{CC}	Power	N/A	V _{CC} . This signal provides power to the chip.
33	V _{CC}	V _{CC}	Power	N/A	V _{CC} . This signal provides power to the chip.
39	V _{CC}	V _{CC}	Power	N/A	V _{CC} . This signal provides power to the chip.
55	V _{CC}	V _{CC}	Power	N/A	V _{CC} . This signal provides power to the chip.
4	GND	GND	Power	N/A	GND. Connect to ground with as short a path as possible.
8	GND	GND	Power	N/A	GND. Connect to ground with as short a path as possible.
12	GND	GND	Power	N/A	GND. Connect to ground with as short a path as possible.
16	GND	GND	Power	N/A	GND. Connect to ground with as short a path as possible.
20	GND	GND	Power	N/A	GND. Connect to ground with as short a path as possible.
24	GND	GND	Power	N/A	GND. Connect to ground with as short a path as possible.
28	GND	GND	Power	N/A	GND. Connect to ground with as short a path as possible.
34	GND	GND	Power	N/A	GND. Connect to ground with as short a path as possible.
40	GND	GND	Power	N/A	GND. Connect to ground with as short a path as possible.
47	GND	GND	Power	N/A	GND. Connect to ground with as short a path as possible.
50	GND	GND	Power	N/A	GND. Connect to ground with as short a path as possible.
56	GND	GND	Power	N/A	GND. Connect to ground with as short a path as possible.
21	XIN	XIN	Input	N/A	24 MHz crystal IN or external clock input.
22	XOUT	XOUT	Output	N/A	24 MHz crystal OUT. (NC if external clock is used)
46	RESET#	RESET#	Input	N/A	Active LOW reset. This pin resets the entire chip. It is normally tied to V _{CC} through a 100 K resistor, and to GND through a 0.1 μF capacitor. No other special power-up procedure is required.
45	SELPWR	SELPWR	Input	N/A	Self power. Indicator for bus or self powered. 0 is bus powered, 1 is self powered.
26	VBUSPOWER	VBUSPOWER	Input	N/A	VBUS. Connect to the VBUS pin of the upstream connector. This signal indicates to the hub that it is in a connected state, and may enable the D+ pull-up resistor to indicate a connection. (The hub does so after the external EEPROM is read).
SPI Interface					
25	SPI_CS	SPI_CS	Output	O	SPI chip select. Connect to CS pin of the EEPROM.
48	SPI_SCK	SPI_SCK	Output	O	SPI clock. Connect to EEPROM SCK pin.
49	SPI_SD	SPI_SD	I/O/Z	Z	SPI dataline connect to GND with 15 kΩ resistor and to the Data I/O pin of the EEPROM.
Upstream Port					
17	D-	D-	I/O/Z	Z	Upstream D- Signal.
18	D+	D+	I/O/Z	Z	Upstream D+ Signal.

Note

3. Unused port DD+/DD- lines can be left floating. Leave the port power, amber, and green LED pins unconnected, and deassert the overcurrent pin. Do not leave the overcurrent pin floating; it is an input. SPI data line should be connected to GND with 15 kΩ resistor (Even if no EEPROM is used).

Table 3. Pin Assignments^[3] (continued)

Pin	CY7C65630 Name	CY7C65620 Name	Type	Default	Description
Downstream Port 1					
13	DD-[1]	DD-[1]	I/O/Z	Z	Downstream D- Signal.
14	DD+[1]	DD+[1]	I/O/Z	Z	Downstream D+ Signal.
36	AMBER#[1]	AMBER#[1]	Output	1	LED. Driver output for Amber LED. Port indicator support. Default is active LOW. Polarity is controlled through EEPROM.
35	GREEN#[1]	GREEN#[1]	Output	1	LED. Driver output for Green LED. Port indicator support. Default is active LOW. Polarity is controlled through EEPROM.
30	OVR#[1]	OVR#[1]	Input	1	Overcurrent condition detection input. Default is active LOW. Polarity is controlled through EEPROM.
29	PWR#[1]	PWR#[1]	O/Z	Z	Power switch driver output. Default is active LOW. Polarity is controlled through EEPROM.
Downstream Port 2					
9	DD-[2]	DD-[2]	I/O/Z	Z	Downstream D- Signal.
10	DD+[2]	DD+[2]	I/O/Z	Z	Downstream D+ Signal.
38	AMBER#[2]	AMBER#[2]	Output	1	LED. Driver output for amber LED. Port indicator support. Default is active LOW. Polarity is controlled through EEPROM.
37	GREEN#[2]	GREEN#[2]	Output	1	LED. Driver output for green LED. Port indicator support. Default is active LOW. Polarity is controlled through EEPROM.
32	OVR#[2]	OVR#[2]	Input	1	Overcurrent condition detection input. Default is active LOW. Polarity is controlled through EEPROM.
31	PWR#[2]	PWR#[2]	O/Z	Z	Power switch driver output. Default is active LOW. Polarity is controlled through EEPROM.
Downstream Port 3					
5	DD-[3]	NC	I/O/Z	Z	Downstream D- Signal.
6	DD+[3]	NC	I/O/Z	Z	Downstream D+ Signal.
42	AMBER#[3]	NC	Output	1	LED. Driver output for amber LED. Port indicator support. Default is active LOW. Polarity is controlled through EEPROM.
41	GREEN#[3]	NC	Output	1	LED. Driver output for Green LED. Port indicator support. Default is active LOW. Polarity is controlled through EEPROM.
53	OVR#[3]	Reserved	Input	1	Overcurrent condition detection input. Default is active LOW. Polarity is controlled through EEPROM. Reserved. Pull to deasserted state with external resistor (CY7C65620 only)
54	PWR#[3]	NC	O/Z	Z	Power switch driver output. Default is active LOW. Polarity is controlled through EEPROM.
Downstream Port 4					
1	DD-[4]	NC	I/O/Z	Z	Downstream D- Signal.
2	DD+[4]	NC	I/O/Z	Z	Downstream D+ Signal.
44	AMBER#[4]	NC	Output	1	LED. Driver output for amber LED. Port indicator support. Default is active LOW. Polarity is controlled through EEPROM.
43	GREEN#[4]	NC	Output	1	LED. Driver output for green LED. Port indicator support. Default is active LOW. Polarity is controlled through EEPROM.
51	OVR#[4]	Reserved	Input	1	Overcurrent condition detection input. Default is active LOW. Polarity is controlled through EEPROM. Reserved. Pull to deasserted state with external resistor (CY7C65620 only)
52	PWR#[4]	NC	O/Z	Z	Power switch driver output. Default is active LOW. Polarity is controlled through EEPROM.

Default Descriptors

This section presents the different descriptors that are available. The following tables list the functionality of each descriptor.

Device Descriptor

The standard device descriptor for CY7C65620/CY7C65630 is based on the information found in the SPI EEPROM. The information in the EEPROM overrides the default descriptor values. If no EEPROM is used, the CY7C65620/CY7C65630 enumerates with the default descriptor values as shown in the following table. If a blank EEPROM is connected, the hub enumerates as vendor defined class instead of a hub class. This is for the purpose of programming the EEPROM with the Cypress driver.

Byte	Full Speed	High Speed	Field Name	Description
0	0x12	0x12	bLength	18 bytes
1	0x01	0x01	bDescriptorType	DEVICE_DESCRIPTOR
2,3	0x0110	0x0200	bcdUSB	USB specification 2.0 (1.1 if forced FS)
4	0x09	0x09	bDeviceClass	HUB
5	0x00	0x00	bDeviceSubClass	None
6	0x00	0x01	bDeviceProtocol	None
7	0x40	0x40	bMaxPacketSize0	64 bytes
8,9	0x04B4	0x04B4	wIdVendor	VID (overridden by what is defined in EEPROM)
10,11	0x6560	0x6560	wIdProduct	PID (overridden by what is defined in EEPROM)
12, 13	0x0915	0x0915	wbcdDevice	DID (overridden by what is defined in EEPROM)
14	0x00	0x00	iManufacturer	Overridden by EEPROM
15	0x00	0x00	iProduct	Overridden by EEPROM
16	0x00	0x00	iSerialNumber	Overridden by EEPROM
17	0x01	0x01	bNumConfigurations	One configuration supported

Configuration Descriptor

Byte	Full Speed	High Speed	Field Name	Description
0	0x09	0x09	bLength	9 bytes
1	0x02 ^[4] /0x07 ^[5]	0x02 ^[4] /0x07 ^[5]	bDescriptorType	CONFIG_DESCRIPTOR
2	0x0019	0x0019	wTotalLength	Length of all other descriptors
4	0x01	0x01	bNumInterfaces	1
5	0x01	0x01	bConfigurationValue	The configuration to use
6	0x00	0x00	iConfiguration	Index of string descriptor describing this configuration
7	0xA0 0xE0	0xA0 0xE0	bmAttributes	Value depends on pin 45 - SELFPWR signal SELPWR = 0 yields 0xA0 and =1 yields 0xE0
8	0x28	0x57 ^[4]	bMaxPower	Maximum power consumption of hub from the USB bus

Notes

4. Configured speed descriptor.
5. Other speed descriptor.

Interface Descriptor

Byte	Full Speed	High Speed	Field Name	Description
0	0x09	0x09	bLength	9 bytes
1	0x04	0x04	bDescriptorType	INTERFACE_DESCRIPTOR
2	0x00	0x00	bInterfaceNumber	Number of this interface
3	0x00	0x00	bAlternateSetting	Value used to select this alternate setting for the interface
4	0x01	0x01	bNumEndpoints	Number of endpoints used by this interface (not including endpoint 0)
5	0x09	0x09	bInterfaceClass	Hub class code
6	0x00	0x00	bInterfaceSubClass	Subclass code (assigned by the USB-IF)
7	0x00	0x00	bInterfaceProtocol	Protocol code (assigned by the USB-IF)
8	0x00	0x00	iInterface	Index of the string descriptor describing this interface

Endpoint Descriptor

Byte	Full-Speed	High-Speed	Field Name	Description
0	0x07	0x07	bLength	7 bytes
1	0x05	0x05	bDescriptorType	ENDPOINT_DESCRIPTOR
2	0x81	0x81	bEndpointAddress	IN Endpoint #1
3	0x03	0x03	bmAttributes	Interrupt
4, 5	0x0001	0x0001	wMaxPacketSize	Maximum packet size
6	0xFF	0x0C	bInterval	Polling rate

Device Qualifier Descriptor

Byte	Full-Speed	High-Speed	Field Name	Description
0	0x0A	0x0A	bLength	10 bytes
1	0x06	0x06	bDescriptorType	DEVICE_QUALIFIER
2, 3	0x0200	0x0200	bcdUSB	USB Specification Release Number in Binary-Coded Decimal
4	0x09	0x09	bDeviceClass	Class code (assigned by the USB-IF)
5	0x00	0x00	bDeviceSubClass	Subclass code (assigned by the USB-IF)
6	0x01	0x00	bDeviceProtocol	Protocol code (assigned by the USB-IF)
7	0x40	0x40	bMaxPacketSize0	Maximum packet size for other speed
8	0x01	0x01	bNumConfigurations	Number of other-speed configurations
9	0x00	0x00	bReserved	Reserved for future use, must be zero

Hub Descriptor

Byte	All Speed	Field Name	Description
0	0x09	bLength	9 bytes
1	0x29	bDescriptorType	HUB descriptor
2	0x04 ^[6] 0x02	bNbrPorts	Number of ports supported, CY7C65630 Number of ports supported, CY7C65620
3,4	0x0089 ^[6]	wHubCharacteristics	b1, b0: Logical power switching mode 00: Ganged power switching (all ports' power at once). 01: Individual port power switching (Default in CY7C65620/CY7C65630). b2: Identifies a compound device 0: Hub is not part of a compound device (Default in CY7C65620/CY7C65630). 1: Hub is part of a compound device. b4, b3: Overcurrent protection mode 00: Global overcurrent protection. The hub reports overcurrent as a summation of all ports' current draw, without a breakdown of individual port overcurrent status. 01: Individual port overcurrent protection. The hub reports overcurrent on a per-port basis. Each port has an overcurrent status (Default in CY7C65620/CY7C65630). 1X: No overcurrent protection. This option is allowed only for bus powered hubs that do not implement overcurrent protection. b6, b5: TT think time 00: TT requires at most eight FS bit times of inter transaction gap on a full/low-speed downstream bus (Default in CY7C65620/CY7C65630). b7: Port indicators supported, 0: Port indicators are not supported on its downstream facing ports and the SetPortIndicator request has no effect. 1: Port indicators are supported on its downstream facing ports and the SetPortIndicator request controls the indicators. See "Functional Overview" on page 5 and "Supported USB Requests" on page 18. (Default in CY7C65620/CY7C65630). b15, b8: Reserved
5	0x32 ^[6]	bPwrOn2PwrGood	Time from when the port is powered to when the power is good on that port.
6	0x28 ^[6] 0xAE ^[6]	bHubContrCurrent	Maximum current requirement for the hub controller at full-speed. Maximum current requirement for the hub controller at high-speed.
7	0x00 ^[6]	bDeviceRemovable	Indicates if the logical port has a removable device attached (0 = removable, 1 = non removable).
8	0xFF ^[6]	bPortPwrCtrlMask	Required for compatibility with software written for 1.0 compliant devices.

Note

6. This value is configured through the external EEPROM.

Configuration Options

Systems using CY7C65620/CY7C65630 have the option of using a fuse ROM, which is preset at the factory to configure the hub. Otherwise, it must have an external EEPROM for the device to have a unique VID, PID, and DID. The CY7C65620/CY7C65630 can communicate with SPI EEPROM that are either double byte addressed or single byte with the ninth bit within the instruction byte, such as the 24LC040 parts use. The 25LC080 EEPROM uses the double byte address format. Therefore, the CY7C65620/CY7C65630 can communicate with these parts. The '010s and '020s use the same command format that is used to interface with the '040 and hence these can also be used to interface with the CY7C65620/CY7C65630.

If the attached EEPROM is blank (0xFF) the hub enumerates as a vendor class device. In this configuration, the hub connects to the Cypress driver to allow programming of the EEPROM. When the EEPROM is programmed, a power cycle configures the chip as a hub class device.

0xD0 Load

With this EEPROM format, only a unique VID, PID, and DID must be present in the external SPI EEPROM. The contents of the EEPROM must contain this information in the following format:

Byte	Value
0	0xD0
1	VID (LSB)
2	VID (MSB)
3	PID (LSB)
4	PID (MSB)
5	reserved
6	DID (MSB)

0xD2 Load

Byte	Value (MSB ≥ LSB)
0	0xD2
1	VID (LSB)
2	VID (MSB)
3	PID (LSB)
4	PID (MSB)
5	reserved
6	DID (MSB)
7	EnabledOverCurrentTimer[3:0], DisableOvercurrentTimer[3:0]
8	ActivePorts[3:0], RemovablePorts[3:0]
9	MaxPower
10	HubControllerPower
11	PowerOnTimer
12	IllegalHubDescriptor, CompoundDevice, FullspeedOnly, NoPortIndicators, Reserved, GangPowered, Reserved, Reserved

Byte 0: 0xD2

Needs to be programmed with 0xD2

Byte 1: VID (LSB)

Least significant byte of vendor ID

Byte 2: VID (MSB)

Most significant byte of vendor ID

Byte 3: PID (LSB)

Least significant byte of product ID

Byte 4: PID (MSB)]

Most significant byte of product ID

Byte 5: Reserved

Reserved

Byte 6: DID (MSB)]

Most significant byte of device ID

Byte 7: EnabledOvercurrentTimer[3:0], DisabledOvercurrentTimer[3:0]

Count time in ms for filtering overcurrent detection. Bits 7–4 are for an enabled port, and bits 3–0 are for a disabled port. Both range from 0 ms to 15 ms. See [Port Indicators on page 6](#). Default: 8 ms = 0x88.

Byte 8: ActivePorts[3:0], RemovablePorts[3:0]

Bits 7–4 are the ActivePorts[3:0] bits that indicates if the corresponding port is usable. For example, a two-port hub that uses ports 1 and 4 would set this field to 0x09. The total number of ports reported in the Hub Descriptor: bNbrPorts field is calculated from this. Bits 3–0 are the RemovablePorts[3:0] bits that indicates whether the corresponding logical port is removable (set to high). Logical port numbers are from 1 to n where n is the total number of active ports. If port 2 is disabled then physical ports 1, 3, and 4 map to logical ports 1, 2, and 3. These bit values are reported appropriately in the HubDescriptor:DeviceRemovable field. Default: 0xFF.

Byte 9: MaximumPower

This value is reported in the ConfigurationDescriptor:bMaxPower field and is the current in 2 mA increments that is required from the upstream hub. Default: 0x28 = 80 mA for full-speed and 0x57 = 174 mA for high-speed.

Byte 10: HubControllerPower

This value is reported in the HubDescriptor:bHubContrCurrent field and is the current in milliamperes required by the hub controller. Default: 0x50 = 80 mA for full-speed and 0xAE = 174 mA for high-speed.

Byte 11: PowerOnTimer

This value is reported in the HubDescriptor:bPwrOn2PwrGood field and is the time in 2 ms intervals from the SetPortPower command until the power on the corresponding downstream port is good. Default: 0x32 = 100 ms.

Byte 12: IllegalHubDescriptor, CompoundDevice, Full Speed Only, NoPortIndicators, Reserved, GangPowered, Reserved, Reserved

Bit 7: IllegalHubDescriptor. For GetHubDescriptor request, some USB hosts use a DescriptorType of 0x00 instead of HUB_DESCRIPTOR, 0x29. According to the USB 2.0 standard, a hub must treat this as a Request Error, and STALL the transaction accordingly (USB 2.0, 11.24.2.5). For systems that do not accept this, the IllegalHubDescriptor configuration bit can be set to allow CY7C65620/CY7C65630 to accept a DescriptorType of 0x00 for this command. Default is 1.

Bit 6: CompoundDevice. Indicates whether the hub is part of a compound device. This is reported in the HubDescriptor, wHub-Characteristics: b2. Default set to '0'.

Bit 5: Fullspeed. Only configures the hub to be a full-speed only device. Default is set to '0'.

Bit 4: NoPortIndicators. Turns off the port indicators and does not report them as present in the HubDescriptor, wHubCharacteristics b7 field. Default is set to '0'.

Bit 3: Reserved. Set this bit to '0'.

Bit 2: GangPowered. Indicates whether the port power switching is ganged (set to 1) or per-port (set to '0'). This is reported in the HubDescriptor, wHubCharacteristics field, b4, b3, b1, and b0. Default is set to '0'.

Bit 1: Reserved. Default is set to '0'.

Bit 0: Reserved. Default is set to '0'.

0xD4 Load

Byte	Value (MSB ≥ LSB)	Factory Fusable
0	0xD4	
1	VID (LSB)	X
2	VID (MSB)	X
3	PID (LSB)	X
4	PID (MSB)	X
5	reserved	
6	DID (MSB)	X
7	EnabledOverCurrentTimer[3:0], DisableOvercurrentTimer[3:0]	
8	MaxPower (full-speed)	X
9	MaxPower (high-speed)	X
10	Reserved	
11	Reserved	
12	HubControllerPower full-speed bus powered	X
13	HubControllerPower high-speed bus powered	X
14	HubControllerPower full-speed self powered	

0xD4 Load (continued)

Byte	Value (MSB ≥ LSB)	Factory Fusable
15	HubControllerPower high-speed self powered	
16	PowerOnTimer	
17	IllegalHubDescriptor, CompoundDevice, FullspeedOnly, NoPortIndicators, Reserved, GangPowered, Reserved, Reserved	X
18	AmberPolarity, GreenPolarity, ModulateIndicators, PowerControlPolarity, OverCurrentPolarity, OverCurrentMode1, OverCurrentMode2	X
19	Write protect	
20	NumLangs	
21	SupportedStrings	
22	ActivePorts[3:0]	
23	RemovablePorts[3:0]	X
24	LangID	
a=24+2N	iManufacturer	
b=a+2N	iProduct	
c=b+2N	iSerialNumber	
d=c+2N	iConfiguration(FS)	
e=d+2N	iConfiguration(HS)	
f=e+2N	iInterface(0)	
g=f+2N	reserved	
h=g+2N	Strings	

N:NumLangs

Byte 0: 0xD4

Needs to be programmed with 0xD4

Byte 1: VID (LSB)

Least significant byte of vendor ID

Byte 2: VID (MSB)

Most significant byte of vendor ID

Byte 3: PID (LSB)

Least significant byte of product ID

Byte 4: PID (MSB)

Most significant byte of product ID

Byte 5: Reserved

Reserved

Byte 6: DID (MSB)

Most significant byte of device ID

Byte 7: EnabledOvercurrentTimer[3:0], DisabledOvercurrentTimer[3:0]

Count time in ms for filtering overcurrent detection. Bits 7–4 are for an enabled port, and bits 3–0 are for a disabled port. Both range from 0 ms to 15 ms. See [Port Indicators on page 6](#). Default: 8 ms = 0x88.

Byte 8: MaximumPower (Full-speed)

This value is reported in the ConfigurationDescriptor:bMaxPower field and is the current in 2 mA increments that is required from the upstream hub when connected at full-speed. Default: 0x28 = 80 mA for full-speed.

Byte 9: MaximumPower (High-speed)

This value is reported in the ConfigurationDescriptor:bMaxPower field and is the current in 2 mA increments that is required from the upstream hub when connected at high-speed. Default: 0x57 = 174 mA for high-speed.

Byte 10: Reserved

Write zeros to this location.

Byte 11: Reserved

Write zeros to this location.

Byte 12: HubControllerPower (Full-speed, bus-powered)

This value is reported in the HubDescriptor:bHubContrCurrent field and is the current in milliamperes required by the hub controller when connected on the upstream hub as a full-speed. Default: 0x50 = 80 mA for full-speed.

Byte 13: HubControllerPower (High-speed, bus-powered)

This value is reported in the HubDescriptor:bHubContrCurrent field and is the current in milliamperes required by the hub controller when connected on the upstream hub as a high-speed. Default: 0xAE = 174 mA for high-speed.

Byte 14: HubControllerPower (Full-speed, self-powered)

This value is reported in the HubDescriptor:bHubContrCurrent field and is the current in milliamperes required by the hub controller when connected on the upstream hub as a full-speed. Default: 0x50 = 80 mA for full-speed.

Byte 15: HubControllerPower (High-speed, self-powered)

This value is reported in the HubDescriptor:bHubContrCurrent field and is the current in milliamperes required by the hub controller when connected on the upstream hub as a high-speed. Default: 0x64 = 100 mA for high-speed.

Byte 16: PowerOnTimer

This value is reported in the HubDescriptor:bPwrOn2PwrGood field and is the time in 2 ms increments from the SetPortPower command until the power on the corresponding downstream port is good. Default: 0x32 = 100 ms.

Byte 17: IllegalHubDescriptor, CompoundDevice, Full-Speed Only, NoPortIndicators, Reserved, GangPowered, Reserved, Reserved

Bit 7: IllegalHubDescriptor. For GetHubDescriptor request, some USB hosts use a DescriptorType of 0x00 instead of HUB_DESCRIPTOR, 0x29. According to the USB 2.0 standard, a hub must treat this as a request error, and STALL the transaction accordingly (USB 2.0, 11.24.2.5). For systems that do not accept this, the IllegalHubDescriptor configuration bit may be set to allow CY7C65620/CY7C65630 to accept a DescriptorType of 0x00 for this command. Default set to 1.

Bit 6: CompoundDevice. Indicates whether the hub is part of a compound device. This is reported in the HubDescriptor, wHub-Characteristics: b2. Default is set to '0'.

Bit 5: Fullspeed. Only configures the hub to be a full speed only device. Default is set to '0'.

Bit 4: NoPortIndicators. Turns off the port indicators and does not report them as present in the HubDescriptor, wHubCharacteristics b7 field. Default is set to '0'.

Bit 3: Reserved. Set this bit to '0'.

Bit 2: GangPowered. Indicates whether the port power switching is ganged (set to 1) or per-port (set to '0'). This is reported in the HubDescriptor, wHubCharacteristics field, b4, b3, b1, and b0. Default is set to '0'.

Bit 1: Reserved. Default is set to '0'.

Bit 0: Reserved. Default is set to '0'.

Byte 18: AmberPolarity, GreenPolarity, SelfPowerable, ModulateIndicators, PowerControlPolarity, OverCurrentPolarity, OverCurrentMode1, OverCurrentMode2

Bit 7: AmberPolarity. Indicates the polarity of the amber indicator control. (1 = high, 0 = low)

Bit 6: GreenPolarity. Indicates the polarity of the green indicator control. (1 = high, 0 = low)

Bit 5: SelfPowerable. Indicates whether the hub is capable of operating in self powered mode. If '0', the hub is capable of bus powered operation only.

Bit 4: ModulateIndicators. If this bit is set, the indicator outputs are modulated by a square wave of 120 Hz, for power savings. If '0', the outputs are static.

Bit 3: PowerControlPolarity. If set, the power control outputs are active HIGH. If not set, the power control outputs are active LOW.

Bit 2: OverCurrentPolarity. If set, the overcurrent inputs are active HIGH. If not set, the overcurrent inputs are active LOW.

Bit 1: OverCurrentMode1. Reported as bit 4 of the wHubCharacteristics field of the hub descriptor. If set to '1', this bit disables overcurrent detection.

Bit 0: OverCurrentMode2. Reported as bit 3 of the wHubCharacteristics field of the hub descriptor. If Bit 1 of this byte is set to '0', overcurrent detection is enabled. If this bit (Bit 0) is set to '1', the hub reports overcurrent on a per-port basis. If set to '0', the hub reports overcurrent as the summation of all ports' current draw.

Byte 19: Write Protect

Writing the value 0x42 to this field enables Write Protect and any future writes to the EEPROM fail. Default is set to '0'.

Byte 20: NumLangs

Number of supported string languages. CY7C65620/CY7C65630 supports a maximum of 31 languages; if this field is set to '0' or a number larger than 31, all string support is disabled.

Byte 21: SupportedStrings

This field contains a bitmap of strings supported by the hub. A set bit indicates that the standard string is supported. A bit not set indicates that the string is not supported. The hub controller returns a non zero index for each string that is supported, and returns 0x00 for each string not supported, as indicated by this field. The bits in this field correspond to the following standard strings.

Table 4. Byte 21 Supported Strings

Bit	Name	Description
7	Reserved	–
6	Reserved	–
5	Interface (0)	The Interface string index reported in the first interface descriptor (alternate setting 0)
4	iConfiguration	(high speed) The iConfiguration string index reported in the configuration descriptor, when operating at high speed
3	iConfiguration	(full speed) The iConfiguration string index reported in the configuration descriptor, when operating at full speed
2	iSerial Number	The iSerialNumber string index reported in the device descriptor
1	iProduct	The iProduct string index reported in the device descriptor
0	iManufacturer	The iManufacturer string index reported in the device descriptor

Byte 22: ActivePorts[3:0]

Bits 3–0 are the ActivePorts[3:0] bits that indicates if the corresponding port is usable. For example, a two-port hub that uses ports 1 and 4 sets this field to 0x09. The total number of ports reported in the Hub Descriptor: bNbrPorts field is calculated from this. Default 0x0F.

Byte 23: RemovablePorts[3:0]

Bits 3–0 are the RemovablePorts[3:0] bits that indicates whether the corresponding logical port is removable (set to high). Logical port numbers are from 1 to n where n is the total number of active ports. If port 2 is disabled then physical ports 1, 3, and 4 map to logical ports 1, 2, and 3. These bit values are recorded in the HubDescriptor:DeviceRemovable field. Default 0x0F.

Byte 24: LangID

Array of LangID codes supported by the hub. Each LangID consists of two bytes, stored LSB first. The array has NumLangs entries (2 × NumLangs bytes).

Byte a: iManufacturer

Array of addresses for the iManufacturer strings. Each address is two bytes long, stored LSB first. The array has NumLangs entries (2 × NumLangs bytes). The starting EEPROM address is based upon the number entered for NumLangs. The address $a = 24 + 2 \times \text{NumLangs}$.

Byte b: iProduct

Array of addresses for the iProduct strings. Each address is two bytes long, stored LSB first. The array has NumLangs entries (2 × NumLangs bytes). The address $b = a + 2 \times \text{NumLangs}$.

Byte c: iSerialNumber

Array of addresses for the iSerialNumber strings. Each address is two bytes long, stored LSB first. The array has NumLangs entries (2 × NumLangs bytes). The address $c = b + 2 \times \text{NumLangs}$.

Byte d: iConfiguration(Full Speed)

Array of addresses for the iConfiguration (full speed) strings. Each address is two bytes long, stored LSB first. The array has NumLangs entries (2 × NumLangs bytes). The address $d = c + 2 \times \text{NumLangs}$.

Byte e: iConfiguration(High Speed)

Array of addresses for the iConfiguration (high speed) strings. Each address is two bytes long, stored LSB first. The array has NumLangs entries (2 × NumLangs bytes). The address $e = d + 2 \times \text{NumLangs}$.

Byte f: iInterface(0)

Array of addresses for the iInterface(0) strings. Each address is two bytes long, stored LSB first. The array has NumLangs entries (2 × NumLangs bytes). The address $f = e + 2 \times \text{NumLangs}$.

Byte g: iInterface(1)

Reserved

Byte h: Strings

Strings addressed by the string pointers. Strings must comply with the USB specification. The first byte must be the length of the string in bytes, the second must be 0x03, and the string must be in Unicode.

Supported USB Requests

Device Class Commands

Table 5. Device Class Requests

Request	bmRequestType	bRequest	wValue	wIndex	wLength	Data
GetDeviceStatus	10000000B	0x00	0x0000	0x0000	0x0002	2 Byte device status
GetInterfaceStatus	10000001B	0x00	0x0000	0x0000	0x0002	2 Byte interface status
GetEndpointStatus	10000010B	0x00	0x0000	0x0000	0x0002	2 Byte endpoint status
GetDeviceDescriptor	10000000B	0x06	0x0001	Zero or language ID	Descriptor length	Descriptor
GetConfigDescriptor	10000000B	0x06	0x0002	Zero or language ID	Descriptor length	Descriptor
GetDeviceQualifierDescriptor	10000000B	0x06	0x0006	Zero or language ID	Descriptor length	Descriptor
GetOtherSpeedConfiguration Descriptor	10000000B	0x06	0x0007	Zero or language ID	Descriptor length	Descriptor
GetConfiguration ^[7]	10000000B	0x08	0x0000	0x0000	0x0001	Configuration value
SetConfiguration ^[7]	00000000B	0x09	Configuration value	0x0000	0x0000	None
GetInterface	10000001B	0xA	0x0000	0x0000	0x0001	Interface number

SetInterface	00000001B	0x0B	Alternate setting	Interface number	0x0000	None
SetAddress	00000000B	0x05	Device address	0x0000	0x0000	None
SetDeviceRemoteWakeup	00000000B	0x03	0x01	0x0000	0x0000	None
SetDeviceTest_J	00000000B	0x03	0x02	0x0100	0x0000	None
SetDeviceTest_K	00000000B	0x03	0x02	0x0200	0x0000	None
SetDeviceTest_SE0_NAK	00000000B	0x03	0x02	0x0300	0x0000	None
SetDeviceTest_Packet	00000000B	0x03	0x02	0x0400	0x0000	None
SetEndpointHalt	00000000B	0x03	0x00	0x0000	0x0000	None
ClearDeviceRemoteWakeup	00000000B	0x01	0x01	0x0000	0x0000	None
ClearEndpointHalt	00000000B	0x01	0x00	0x0000	0x0000	None

Note

7. Only one configuration is supported in CY7C65620/CY7C65630.

Hub Class Commands

Table 6. Hub Class Requests

Request	bmRequestType	bRequest	wValue	wIndex	wLength	Data
GetHubStatus	10100000B	0x00	0x0000	0x0000	0x0004	Hub status (See Table 11-19 of USB 2.0 Specifications) Change status (See Table 11-20 of USB 2.0 specifications)
GetPortStatus	10100011B	0x00	0x0000	Byte 0: 0x00 Byte 1: Port	0x0004	Port status (See Table 11-21 of USB 2.0 Specifications) Change status (See Table 11-20 of USB 2.0 specifications)
ClearHubFeature	00100000B	0x01	Feature selectors ^[8] 0 or 1	0x0000	0x0000	None
ClearPortFeature	00100011B	0x01	Feature selectors ^[8] 1, 2, 8, 16, 17, 18, 19, or 20	Byte 0: 0x00 Byte 1: Port	0x0000	None
ClearPortFeature	00100011B	0x01	Feature selectors ^[8] 22 (PORT_INDI- CATOR)	Byte 0: - Byte 1: Port	0x0000	None
SetHubFeature	00100000B	0x03	Feature selector ^[8] 0 or 1	0x0000	0x0000	None
SetPortFeature	00100011B	0x03	Feature selectors ^[8] 2, 4 or 8	Port	0x0000	None
SetPortFeature	00100011B	0x03	Feature selector ^[8] 21 (PORT_TEST)	Byte 0: selectors ^[8] 1,2, 3, 4 or 5 Byte 1: Port	0x0000	None

SetPortFeature	00100011B	0x03	Feature selector ^[8] 22 (PORT_INDICATOR)	Byte 0: selectors ^[9] 0, 1, 2, or 3 Byte 1: Port	0x0000	None
GetHubDe- scriptor	10100000B	0x06	Descriptor type and descriptor index	Zero/ Language ID	Hub descriptor length	Descriptor
ClearTTBuffer	00100011B	0x08	Dev_Addr, EP_Num	TT_Port	0x0000	None
ResetTT	00100000B	0x09	0x0000	Byte 0: 0x00 Byte 1: Port	0x0000	None
GetTTState	10100011B	0x0A	TT_Flags	Byte 0: 0x00 Byte 1: Port	TT state length	TT state
StopTT	00100011B	0x0B	0x0000	Byte 0: 0x00 Byte 1: Port	0x0000	None

Notes

8. Selector values for different features are presented in [Table 7 on page 20](#).
9. Selector values for different features are presented in [Table 9 on page 20](#).

Table 6. Hub Class Requests (continued)

Request	bmRequestType	bRequest	wValue	wIndex	wLength	Data
Vendor Commands						
Read EEPROM	11000000B	0x02	0x00	0x00	Length	Data
This request results in reading length bytes of data from the external memory device and returned to the host. Data is read beginning with address 0. This request fails if there is no external memory device present. This request is only valid if the hub is in the configured state; the request fails otherwise.						
Write EEPROM	01000000B	0x01	0x00	0x00	Length	Data
This request results in writing length bytes of data to the external memory device. Data is written beginning with address 0. This request fails if there is no external memory device present. This request is only valid if the hub is in the configured state or if the external memory device write protect byte is set; the request fails otherwise.						

Table 7. Hub Class Feature Selector

Feature Selector	Recipient	Value
C_HUB_LOCAL_POWER	Hub	0
C_HUB_OVER_CURRENT	Hub	1
PORT_CONNECTION	Port	0
PORT_ENABLE	Port	1
PORT_SUSPEND	Port	2
PORT_RESET	Port	4
PORT_POWER	Port	8
PORT_LOW_SPEED	Port	9
C_PORT_CONNECTION	Port	16
C_PORT_ENABLE	Port	17
C_PORT_SUSPEND	Port	18
C_PORT_OVER_CURRENT	Port	19
C_PORT_RESET	Port	20
PORT_TEST	Port	21
PORT_INDICATOR	Port	22

Table 8. Test Mode Selector for Feature Selector PORT_TEST (21)^[10]

PORT_TEST Mode Description	Selector Value
Test_J	1
Test_K	2
Test_SE0_NAK	3
Test_Packet	4
Test_Force_Enable	5

Table 9. Port Indicator Selector for Feature Selector PORT_INDICATOR (22)

Port Indicator Color	Selector Value	Port Indicator Mode
Color set automatically as shown in Table 1 on page 7	0	Automatic mode
Amber	1	Manual mode
Green	2	Manual mode
Off	3	Manual mode

Note

 10. Selector values for different features are presented in [Table 8](#).

Upstream USB Connection

The following is a schematic of the USB upstream connector.

Figure 2. USB Upstream Port Connection

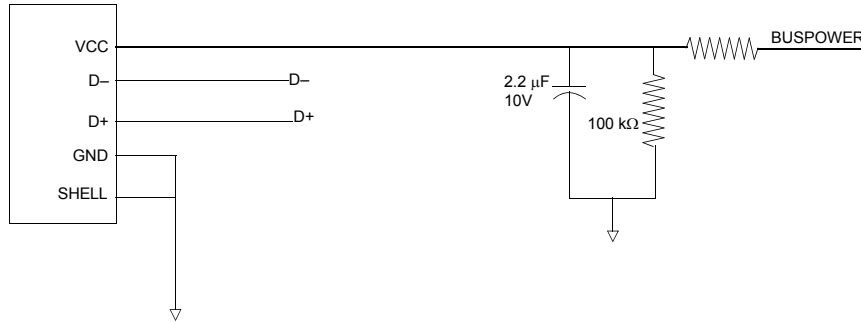

Downstream USB Connection

The following is a schematic of the USB downstream connector.

Figure 3. USB Downstream Port Connection

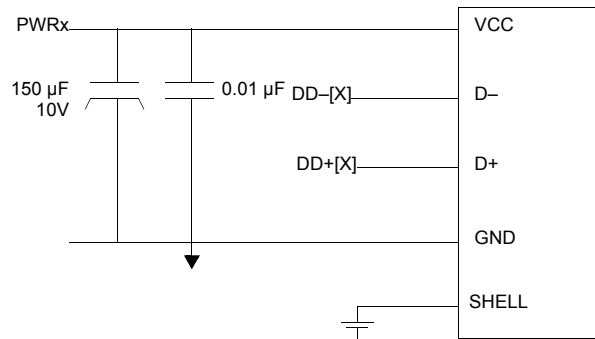

LED Connection

The following is a schematic of the LED circuitry.

Figure 4. USB Downstream Port Connection

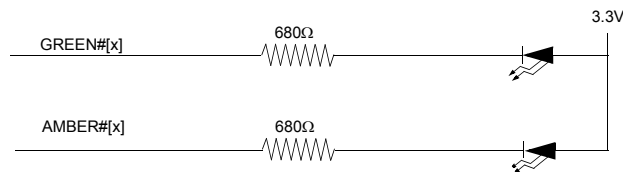

System Block Diagram

Figure 5. Sample Schematic for 4-port Self Powered Configuration

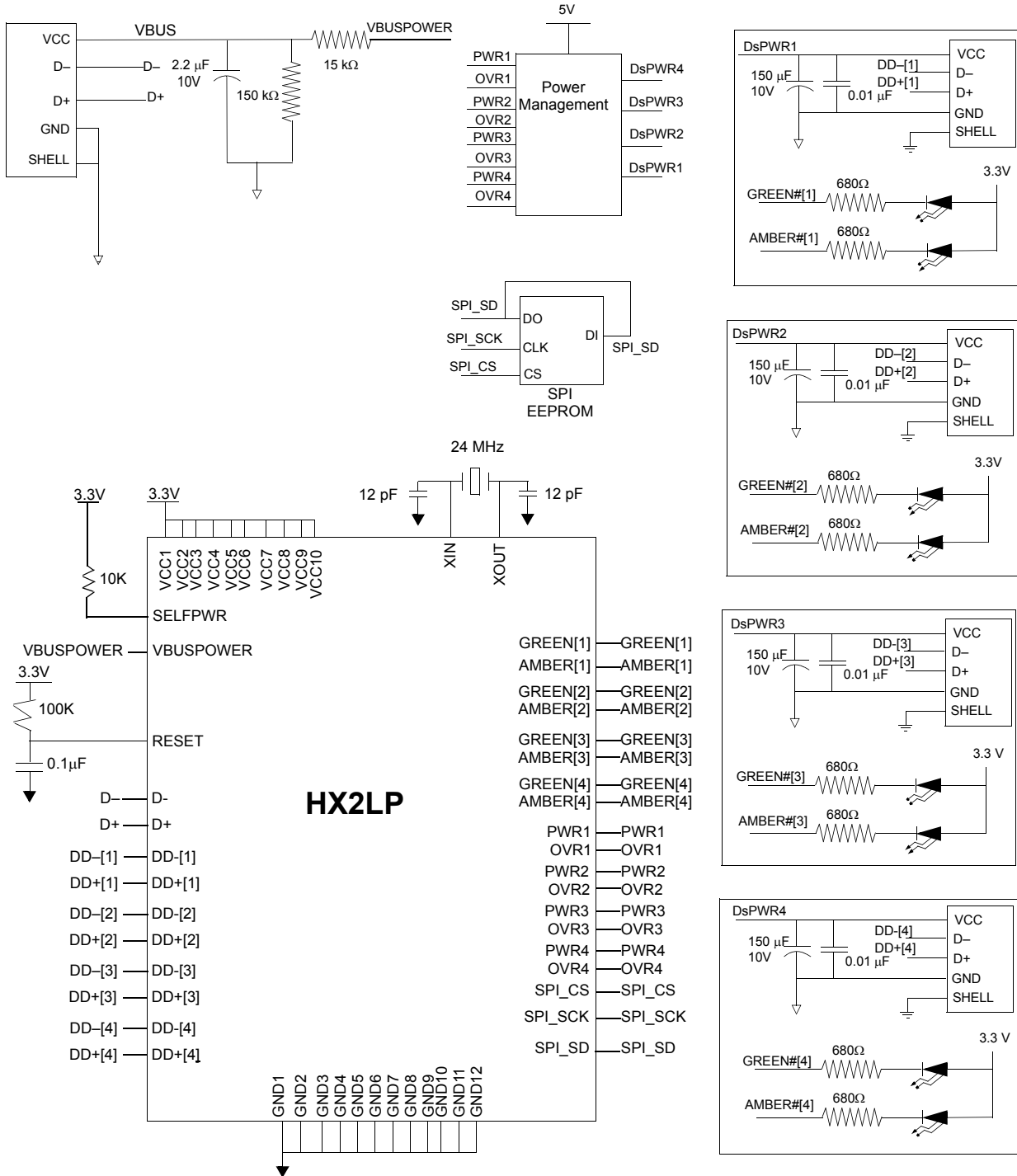

Absolute Maximum Ratings

Exceeding maximum ratings may impair the useful life of the device. These user guidelines are not tested.

Storage temperature	-65 °C to +150 °C
Ambient temperature with power applied:	
Commercial	0 °C to +70 °C
Automotive	-40 °C to +85 °C
Industrial	-40 °C to +85 °C
Supply voltage to ground potential	-0.5 V to +4.0 V
DC voltage applied to outputs in high Z state	-0.5 V to $V_{CC} + 0.5$ V
Power dissipation (4 HS ports)	0.9 W
Static discharge voltage	> 2000 V
Maximum output sink current per I/O	10 mA

Reset period
 (the minimum period between when V_{CC} reaches the minimum operating voltage and de-assertion of the reset line) 1.9 ms

Operating Conditions

T_A (ambient temperature under bias)	
Commercial	0 °C to +70 °C
Automotive	-40 °C to +85 °C
Industrial	-40 °C to +85 °C
Supply voltage	+3.15 V to +3.45 V
Ground voltage	0 V
FOSC (oscillator or crystal frequency) parallel resonant, 12 pF load capacitance, 0.5 mW	24 MHz \pm 0.05%

Electrical Characteristics

DC Electrical Characteristics

Parameter	Description	Conditions	Min	Typ	Max	Unit
V_{CC}	Supply voltage		3.15	3.3	3.45	V
V_{CC} RampUp	Ramp rate on V_{CC}		-	-	18	V/ms
V_{IH}	Input high voltage		2	-	5.25	V
V_{IL}	Input low voltage		-0.5	-	0.8	V
I_I	Input leakage current	$0 < V_{IN} < V_{CC}$	-	-	± 10	μ A
V_{OH}	Output voltage high	$I_{OUT} = 4$ mA	2.4	-	-	V
V_{OL}	Output low voltage	$I_{OUT} = -4$ mA	-	-	0.4	V
I_{OH}	Output current high		-	-	4	mA
I_{OL}	Output current low		-	-	4	mA
C_{IN}	Input pin capacitance		-	-	10	pF
I_{SUSP}	Suspend current		-	80	-	μ A
I_{CC}	Supply current					
	4 active ports	Full speed host, full-speed devices	-	86	110	mA
		High speed host, high-speed devices	-	231	260	mA
		High speed host, full-speed devices	-	154	180	mA
	2 active ports	Full speed host, full-speed devices	-	77	100	mA
		High speed host, high-speed devices	-	163	190	mA
		High speed host, full-speed devices	-	136	160	mA
	No active ports	Full speed host	-	65	90	mA
		High speed host	-	93	120	mA

USB Transceiver

USB 2.0 certified in full-, low-, and high-speed modes.

AC Electrical Characteristics

Both the upstream USB transceiver and all four downstream transceivers have passed the USB-IF USB 2.0 Electrical Certification Testing.

Table 10. Serial Peripheral Interface

Description	Min	Typ	Max	Unit
Clock rise/fall time	–	–	500	ns
Clock frequency	–	–	250	kHz
Data setup time	50	–	–	ns
Hold time	100	–	–	ns

Ordering Information

Ordering Code	Status	Package Type
CY7C65620-56LTXC	–	56-pin QFN 2-Port Sawn Type QFN Bulk
CY7C65620-56LTXCT	–	56-pin QFN 2-Port Sawn Type QFN Tape and Reel
CY7C65620-56LTXA	NRND*	56-pin QFN 2-Port Automotive AEC grade
CY7C65620-56LTXAT	NRND*	56-pin QFN 2-Port Automotive AEC grade Tape and Reel
CY7C65630-56LTXC	–	56-pin QFN 4-Port Sawn Type QFN Bulk
CY7C65630-56LTXCT	–	56-pin QFN 4-Port Sawn Type QFN Tape and Reel
CY7C65630-56LTXA	NRND*	56-pin QFN 4-Port Automotive AEC grade
CY7C65630-56LTXAT	NRND*	56-pin QFN 4-Port Automotive AEC grade Tape and Reel
CY4606	–	CY7C65630 USB 2.0 4-Port Hub Reference Design Kit
CY4605	–	CY7C65620 USB 2.0 2-Port Hub Reference Design Kit
CY7C65630-56LTXI	–	56-pin QFN 4-Port Industrial grade
CY7C65630-56LTXIT	–	56-pin QFN 4-Port Industrial grade Tape and Reel
CY7C65620-56LTXI	–	56-pin QFN 2-Port Industrial grade
CY7C65620-56LTXIT	–	56-pin QFN 2-Port Industrial grade Tape and Reel

* Not Recommended for New Designs

Ordering Code Definitions

CY 7C656 X0 - 56L X X X X

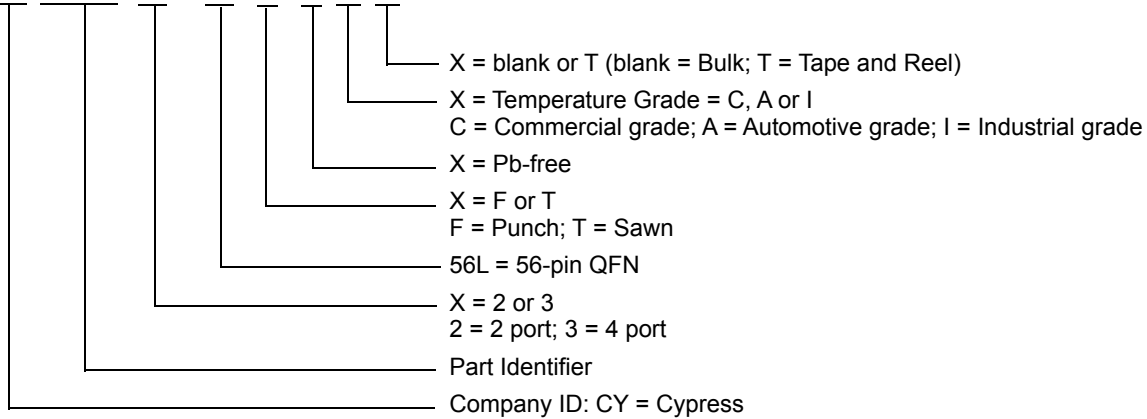

Package Diagrams

The CY7C65620/CY7C65630 is available in a space saving 56-pin QFN (8 × 8 mm).

Figure 6. 56-pin Sawn QFN (8 × 8 × 1.00 mm)

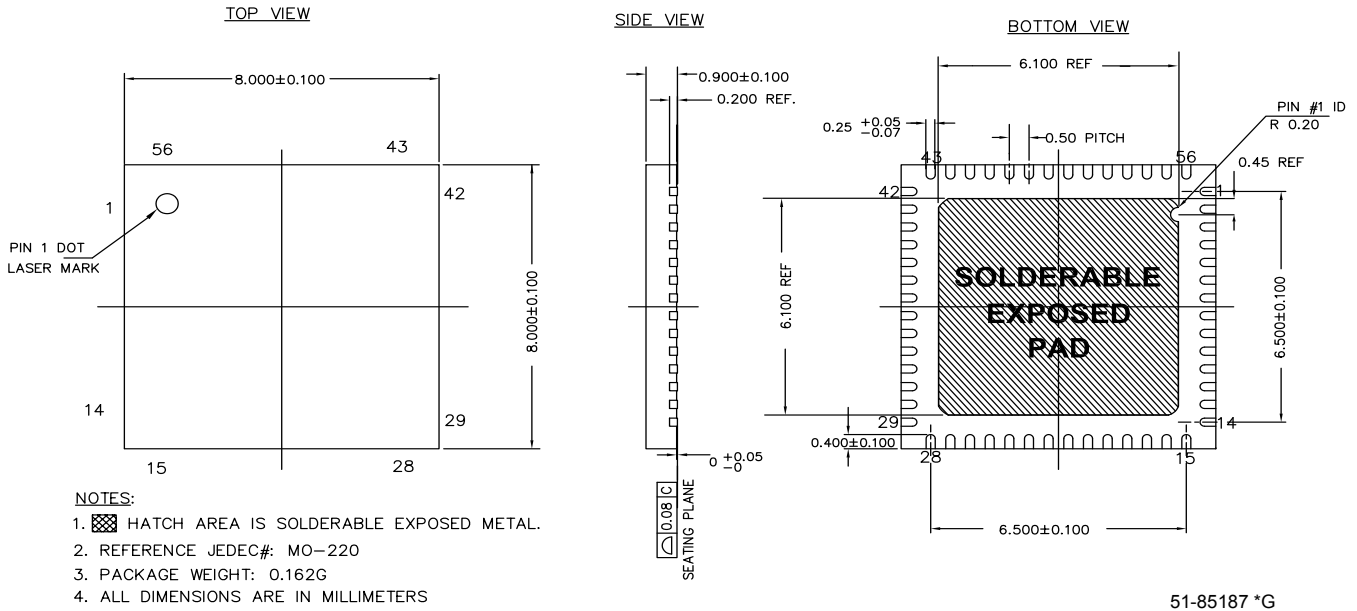
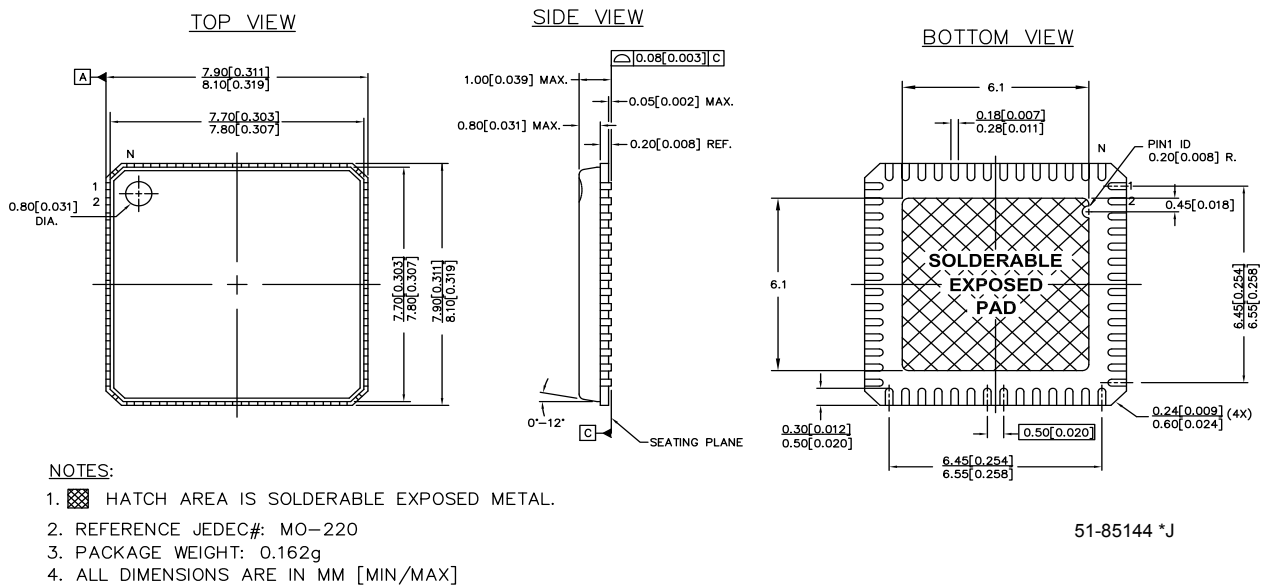

Figure 7. 56-pin QFN 8 × 8 mm LF56A (Subcon Punch Type with 6.1 × 6.1 EPad)



Thermal Impedance for the Package

Package	Typical θ_{JA}	Typical θ_{JC}
56-pin QFN	18.4 °C/W	2.1 °C/W

Acronyms

The following table lists the acronyms that are used in this document.

Acronym	Description
AC	alternating current
AI	analog input
AIO	analog input/output
DO	digital output
GPO	general purpose output
LSB	least significant bit
MSB	most significant bit
P	power pins
PCB	printed circuit board
PLL	phase-locked loop
POR	power-on reset
POST	power on self test
RF	radio frequency

Document Conventions

Units of Measure

The following table lists all the abbreviations used to measure the PSoC devices.

Symbol	Unit of Measure
°C	degree Celsius
kΩ	kilohm
μA	microampere
μs	microsecond
mA	milliampere
ms	millisecond
mV	millivolt
nA	nanoampere
Ω	ohm
pF	picofarad
V	volt

Numeric Naming

Hexadecimal numbers are represented with all letters in uppercase with an appended lowercase 'h' (for example, '14h' or '3Ah'). Hexadecimal numbers may also be represented by a '0x' prefix, the C coding convention. Binary numbers have an appended lowercase 'b' (for example, '01010100b' or '01000011b'). Numbers not indicated by an 'h', 'b', or '0x' are decimal.

Errata

This section describes the errata for the EZ-USB HX2LP™ Low-Power USB 2.0 Hub Controller Family, CY7C65620/30. Details include errata trigger conditions, scope of impact, available workaround, and silicon revision applicability. Contact your local Cypress Sales Representative if you have questions.

Part Numbers Affected

Part Number	Device Characteristics
CY7C65620	All Packages
CY7C65630	All Packages

HX2LP Qualification Status

Product status: Production

HX2LP Errata Summary

1. Non-periodic and Isochronous OUT transfers in the same microframe

■Description

With the operating in High-Speed mode with a Full-Speed device connected to a downstream port, Sometimes, an Isochronous OUT packet gets corrupted on the downstream port.

■Implication

The main cause of this phenomenon is in the way the hub's Transaction Translator downstream handler state machine schedules transactions if non-periodic (Control or Bulk) transactions are found in the non-periodic buffer while an Isochronous OUT transaction is active on the port. If the downstream handler state machine sees an Isochronous OUT packet in the Transaction translation buffer and if it is scheduled in the same micro-frame by the host then it will skip the Isochronous OUT transaction and resume a non-periodic transaction.

■Workaround

The workaround for this issue is for the host controller to avoid scheduling non-periodic traffic such that it will run while an Isochronous OUT transaction is active. Non-periodic traffic can be scheduled to run in the micro-frame before the Isochronous OUT transaction begins, or after the Isochronous OUT transaction completes.

■Status

No plan to fix currently - recommend using workaround.

2. Last data not received in multi-microframe Isochronous IN transfers

■Description

With the hub operating in High-Speed mode with a Full-Speed device connected to a downstream port, Sometimes a multi-microframe Isochronous IN transaction resulted in the last two Complete Split transactions that should have returned data but instead returned NYET handshakes.

■Implication

The main cause of this phenomenon is in the hub's Transaction Translator logic which tracks data stored in the periodic transaction buffer. If the Full-Speed transaction completes before the Complete-Split token is received from the host, there is a chance that buffer will be over-written if the requested Isochronous IN payload is greater than 440 bytes (USB 2.0 specification on buffer size).

■Workaround

The workaround for this issue is for the host controller to avoid scheduling the Complete Split token for the microframe where the Full-Speed packet ends too late in the frame. The TT is guaranteed to work correctly if the Complete Split is received in the first quarter of the microframe.

■Status

No plan to fix currently - recommend using workaround.

Document History Page

Document Title: CY7C65620/CY7C65630, EZ-USB HX2LP™ Low Power USB 2.0 Hub Controller Family				
Document Number: 38-08037				
Revision	ECN	Orig. of Change	Submission Date	Description of Change
**	131505	JTC	02/12/2004	New data sheet.
*A	231329	KKU	See ECN	Changed load capacitors to 12 pF, updated part numbers, added functional overviews, block descriptions, pin configurations, default descriptors, configurations options, supported USB requests, electrical characteristics and package diagram.
*B	250869	ARI	See ECN	Added typical values for I _{CC} in the DC Electrical Characteristics table, changed MPN CY7C65650 to CY7C65640B, added CY7C65620 package.
*C	330195	KKU	See ECN	Added Reset period in to the table in section 'Serial Peripheral Interface'. Added 0xD4 EEPROM Load. Added vendor command values. Added V _{CC} ramp rate. Updated block diagram.
*D	342997	KKU	See ECN	Updated features list. Removed from the Enumeration section "Once the hub is configured, the full hub functionality is available". Added reference to 0xD4 load to the Downstream Ports section. Added reference to polarity control in the Power Switching and Over-current Detection sections. Updated the Automatic Port State to Port Indicator Color Mapping table to match USB-IF spec changes. Added LED modulation to the Port Indicators section . Updated pin description table - SELFPWR# to SELFPWR and removed references to limitations of bus powered. Added reference to polarity control on PWR#, OVR# and LED control lines. Updated Default descriptors. Updated EEPROM list to include 25LC080. Removed NoEOPatEOF1 bit. Added LED polarity control.
*E	498396	TEH	See ECN	Removed all references to HX1TT and Multi-TT. Updated Block Diagrams to remove ports and TTs. Removed Preliminary. Updated Device ID default. Added Write Protect Description. Correct sample schematics to reflect latest RDK. Updated Power Consumption Numbers. Updated Part Numbers.
*F	570287	ARI	See ECN	Corrected typo in Table 3. Changed downstream port 4 signal labels from [3] to [4]. Added dimensions of E-Pads to Figure 6.
*G	852600	KKU	See ECN	Changed feature "2-Port Single TT for bus power support" to "Bus powered configurations". Updated figure 5. Added blank EEPROM statement to the Device Descriptor section. Added blank EEPROM statement to the Configuration Options section. Added indicator for factory fusable options.

Document Title: CY7C65620/CY7C65630, EZ-USB HX2LP™ Low Power USB 2.0 Hub Controller Family
Document Number: 38-08037

*H	1019740	KKU / ARI	See ECN	Added to Features: Automotive AEC grade option (-40-85C). Added to Part numbers: CY7C65630-56LFXA: 56-pin QFN 4-Port Automotive AEC grade. Added absolute ambient temperature with power applied for automotive part. Added operational Ambient Temperature Under Bias for automotive part. Replaced TBD under absolute maximum power dissipation with 0.9 Watts. Removed internal part numbers referenced in figure 6 note 5. Changed "USB 2.0-Compliant" to "USB 2.0-Certified" Removable Ports updated to reflect logical ports. Edited for active voice.
*I	2238608	KKU	See ECN	Block diagrams for CY7C65630 and CY7C65620 were altered in the *H revision and should not have been. Reverted diagrams to *G version.
*J	2370406	PYRS	See ECN	Changing the status from Preliminary to Final as per author's confirmation.
*K	2657415	DPT / PYRS	02/10/09	Added package diagram for 56-pin Sawn QFN.
*L	2705817	GOR / PYRS	05/13/09	Added new part numbers to the ordering information table.
*M	2719596	VIVG / AESA	06/16/2009	Added CY7C65620-56LFXA part in the ordering information table.
*N	2753668	VIVG	08/19/09	Added Tape and Reel for CY7C65620 and CY7C65630 automotive parts.
*O	2857913	VIVG	01/19/2010	Corrected typo in Ordering Information table for CY7C65620-56LFXA. Updated 56-pin Punch and Sawn QFN package diagrams. Added Contents on page 3.
*P	2896582	ODC	03/19/10	Removed obsolete part (CY7C65620-56LFXC) from ordering information table Updated package diagrams.
*Q	3011613	ODC	08/20/2010	Added Ordering Code Definitions. Added the tabular column "Thermal Impedance for the package". Added Document Conventions. Minor edits.
*R	3095394	ODC	11/25/2010	Updated Table 8 on page 20 and Table 9 on page 20 .
*S	3174789	ODC	02/16/2011	Updated 0xD2 Load and 0xD4 Load . Updated Package Diagrams .
*T	3252356	ODC	05/09/2011	Changed title from CY7C656XX EZ-USB HX2LP(TM) Low power USB 2.0 Hub Controller Family to CY7C65620/CY7C65630 EZ-USB HX2LP(TM) Low power USB 2.0 Hub Controller Family .
*U	3501907	PRVE	02/10/2012	Updated Ordering Information and removed parts (CY7C65630-56LFXC, CY7C65630-56LFXCT, and CY7C65620-56LFXCT). Updated Package Diagrams (51-85187 and 51-85144).
*V	3735946	PRVE	09/06/2012	Updated Ordering Information , added four MPNs (CY7C65630-56LTXI, CY7C65630-56LTXIT, CY7C65620-56LTXI, CY7C65620-56LTXIT). Updated Ordering Code Definitions .
*W	3806343	PRJI	11/08/2012	Updated Pin Definitions (Updated Note 3, referred in Table 3).
*X	3830076	PRJI	12/04/2012	Updated Absolute Maximum Ratings (Added Reset period and its details). Updated Electrical Characteristics (Updated AC Electrical Characteristics (Updated Table 10 (Removed Reset period))).
*Y	3992033	PRJI	05/06/2013	Added Errata .
*Z	4033909	PRJI	06/19/2013	Added Errata Footnotes. Updated in new template.
AA	4054137	PRJI	07/09/2013	Updated Ordering Information (Included a column "Status" and updated the status of CY7C65620-56LFXA, CY7C65620-56LFXAT, CY7C65630-56LFXA and CY7C65630-56LFXAT as NRND).

Document Title: CY7C65620/CY7C65630, EZ-USB HX2LP™ Low Power USB 2.0 Hub Controller Family				
Document Number: 38-08037				
AB	4614914	PRJI	01/06/2015	Updated the document to standard template format. Updated Figure 5 (removed VCC11). Updated Figure 6 (spec 51-85187 *F to *G) and Figure 7 (spec 51-85144 *I to *J) in Package Diagrams . Updated the Description for Bytes 6 and 8 in Configuration Descriptor . Updated the Description for Bytes 2 through 8 in Interface Descriptor and Device Qualifier Descriptor . Updated the Data for SetHubFeature and GetHubDescriptor, and updated windex for GetHubDescriptor in Table 6 .
AC	4724071	PRJI	04/14/2015	Updated More Information : Updated description.
AD	5526024	PRJI	11/18/2016	Updated Ordering Information . Updated CY Logo, Copyright, and Disclaimer.
AE	5767382	AESATMP9	06/08/2017	Updated logo and copyright.