

CZRF52C2-HF Thru. CZRF52C39-HF

Voltage 2 to 39 Volts

Power 350 mWatts

RoHS Device

Halogen Free

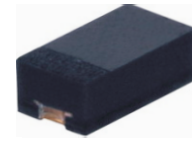

Features

- 350mW Power Dissipation.
- High Voltages from 2 ~ 39 V.
- Designed for mounting on small surface.
- Extremely thin/leadless package.
- Pb free product.

Mechanical data

- Case: 1005/SOD-323F Standard package
Molded plastic.
- Terminals: Gold plated, solderable per MIL-STD-750,method 2026.
- Polarity: Indicated by cathode band.
- Weight: 0.006 gram(approx.).

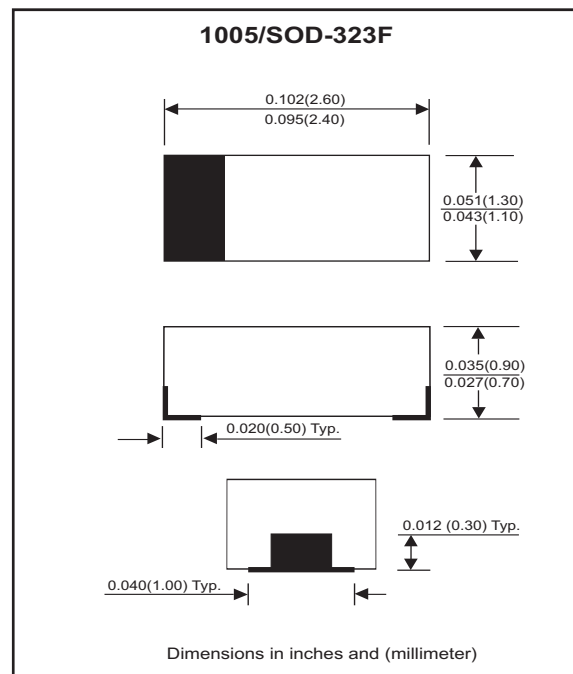

Circuit Diagram



Maximum Rating And Electrical Characteristics (at TA=25°C unless otherwise noted)

| Parameter | Symbol | Value | Unit |
|---|-----------|-------------|------|
| Maximum Forward Voltage Drop at $I_F = 10 \text{ mA}$ | V_F | 0.9 | V |
| Maximum Power Dissipation at 25 °C | P_D | 350 | mW |
| Forward current , surge peak 8.3 ms single half sine-wave superimposed on rate load(JEDEC method) | I_{FSM} | 2.0 | A |
| Peak ESD voltage capability (IEC 61000-4-2) | V_{PV} | 8 | kV |
| Operating Junction and Storage Temperature Range | T_J | -55 to +125 | °C |

Electrical Characteristics(Ta = 25°C)

| Part Number | Marking Code | Zener Voltage | | | Operating resistance | | Rising operating Resistance | | Reverse current | |
|---------------|--------------|--------------------|-------|---------------------|----------------------|---------------------|-----------------------------|---------------------|-----------------|--------------------|
| | | V _Z (V) | | | ZZT(Ohm) | | ZZK(Ohm) | | IR(μA) | |
| | | Min | Max | I _Z (mA) | Max | I _Z (mA) | Max | I _Z (mA) | Max | V _R (V) |
| CZRF52C2-HF | Z0 | 1.90 | 2.10 | 5 | 100 | 5 | 600 | 1 | 100 | 1 |
| CZRF52C2V2-HF | Z1 | 2.09 | 2.31 | 5 | 100 | 5 | 600 | 1 | 100 | 1 |
| CZRF52C2V4-HF | Z2 | 2.28 | 2.52 | 5 | 85 | 5 | 600 | 1 | 100 | 1 |
| CZRF52C2V7-HF | Z3 | 2.57 | 2.84 | 5 | 83 | 5 | 500 | 1 | 75 | 1 |
| CZRF52C3-HF | Z4 | 2.85 | 3.15 | 5 | 95 | 5 | 500 | 1 | 50 | 1 |
| CZRF52C3V3-HF | Z5 | 3.14 | 3.47 | 5 | 95 | 5 | 500 | 1 | 25 | 1 |
| CZRF52C3V6-HF | Z6 | 3.42 | 3.78 | 5 | 95 | 5 | 500 | 1 | 15 | 1 |
| CZRF52C3V9-HF | Z7 | 3.71 | 4.10 | 5 | 95 | 5 | 500 | 1 | 10 | 1 |
| CZRF52C4V3-HF | Z8 | 4.09 | 4.52 | 5 | 95 | 5 | 500 | 1 | 5 | 1 |
| CZRF52C4V7-HF | Z9 | 4.47 | 4.94 | 5 | 78 | 5 | 500 | 1 | 5 | 2 |
| CZRF52C5V1-HF | ZA | 4.85 | 5.36 | 5 | 60 | 5 | 480 | 1 | 0.1 | 0.8 |
| CZRF52C5V6-HF | ZB | 5.32 | 5.88 | 5 | 40 | 5 | 400 | 1 | 0.1 | 1 |
| CZRF52C6V2-HF | ZC | 5.89 | 6.51 | 5 | 10 | 5 | 200 | 1 | 0.1 | 2 |
| CZRF52C6V8-HF | ZE | 6.46 | 7.14 | 5 | 8 | 5 | 150 | 1 | 0.1 | 3 |
| CZRF52C7V5-HF | ZF | 7.13 | 7.88 | 5 | 7 | 5 | 50 | 1 | 0.1 | 5 |
| CZRF52C8V2-HF | ZG | 7.79 | 8.61 | 5 | 7 | 5 | 50 | 1 | 0.1 | 6 |
| CZRF52C9V1-HF | ZH | 8.65 | 9.56 | 5 | 10 | 5 | 50 | 1 | 0.1 | 7 |
| CZRF52C10-HF | ZJ | 9.50 | 10.50 | 5 | 15 | 5 | 70 | 1 | 0.1 | 7.5 |
| CZRF52C11-HF | ZK | 10.45 | 11.55 | 5 | 20 | 5 | 70 | 1 | 0.1 | 8.5 |
| CZRF52C12-HF | ZM | 11.40 | 12.60 | 5 | 20 | 5 | 90 | 1 | 0.1 | 9 |
| CZRF52C13-HF | ZN | 12.35 | 13.65 | 5 | 25 | 5 | 110 | 1 | 0.1 | 10 |
| CZRF52C15-HF | ZP | 14.25 | 15.75 | 5 | 30 | 5 | 110 | 1 | 0.1 | 11 |
| CZRF52C16-HF | ZQ | 15.20 | 16.80 | 5 | 40 | 5 | 170 | 1 | 0.1 | 12 |
| CZRF52C18-HF | ZR | 17.10 | 18.90 | 5 | 50 | 5 | 170 | 1 | 0.1 | 14 |
| CZRF52C20-HF | ZS | 19.00 | 21.00 | 5 | 50 | 5 | 220 | 1 | 0.1 | 15 |
| CZRF52C22-HF | ZT | 20.90 | 23.10 | 5 | 55 | 5 | 220 | 1 | 0.1 | 17 |
| CZRF52C24-HF | ZU | 22.80 | 25.20 | 5 | 80 | 5 | 220 | 1 | 0.1 | 18 |
| CZRF52C27-HF | ZV | 25.65 | 28.35 | 5 | 80 | 5 | 250 | 1 | 0.1 | 20 |
| CZRF52C30-HF | ZW | 28.50 | 31.50 | 5 | 80 | 5 | 250 | 1 | 0.1 | 23 |
| CZRF52C33-HF | ZX | 31.35 | 34.65 | 5 | 80 | 5 | 250 | 1 | 0.1 | 25 |
| CZRF52C36-HF | ZY | 34.20 | 37.80 | 5 | 90 | 5 | 250 | 1 | 0.1 | 27 |
| CZRF52C39-HF | ZZ | 37.05 | 40.95 | 5 | 90 | 5 | 300 | 1 | 0.1 | 29 |

Company reserves the right to improve product design , functions and reliability without notice.

REV:B

RATING AND CHARACTERISTIC CURVES (CZRF52C2-HF Thru. CZRF52C39-HF)

Fig.1 TEMPERATURE COEFFICIENTS

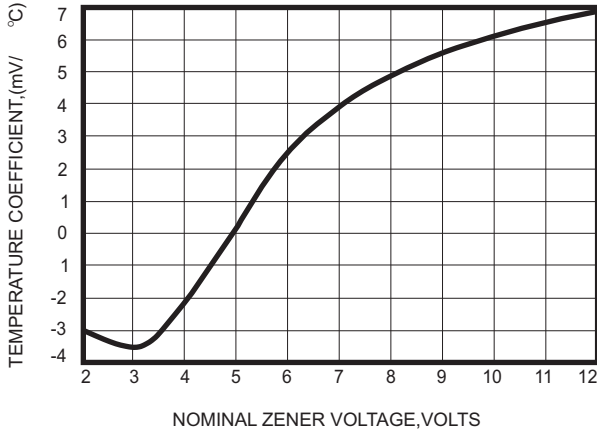

Fig.2 TEMPERATURE COEFFICIENTS

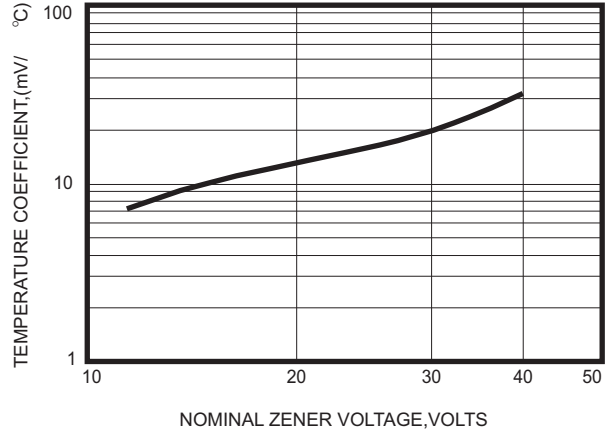

Fig.3 EFFECT OF ZENER VOLTAGE ON ZENER IMPEDANCE



Fig.4 TYPICAL FORWARD VOLTAGE



Fig.5 TYPICAL LEAKAGE CURRENT

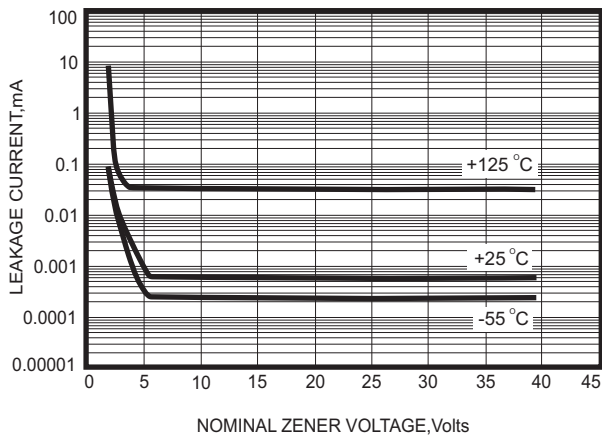
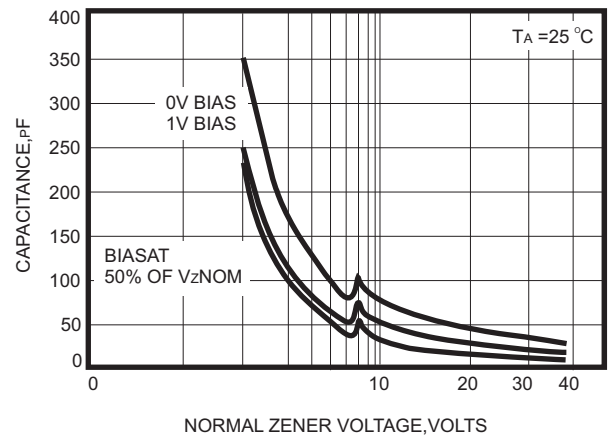

Fig.6 TYPICAL CAPACITANCE



Company reserves the right to improve product design, functions and reliability without notice.

RATING AND CHARACTERISTIC CURVES (CZRF52C2-HF Thru. CZRF52C39-HF)

Fig.7 ZENER VOLTAGE VERSUS ZENER CURRENT

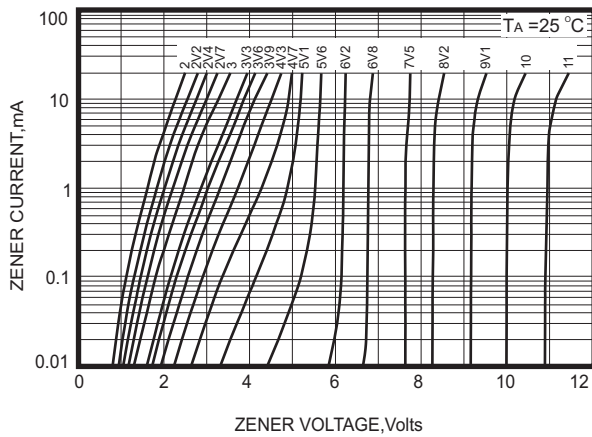

Fig.8 ZENER VOLTAGE VERSUS ZENER CURRENT

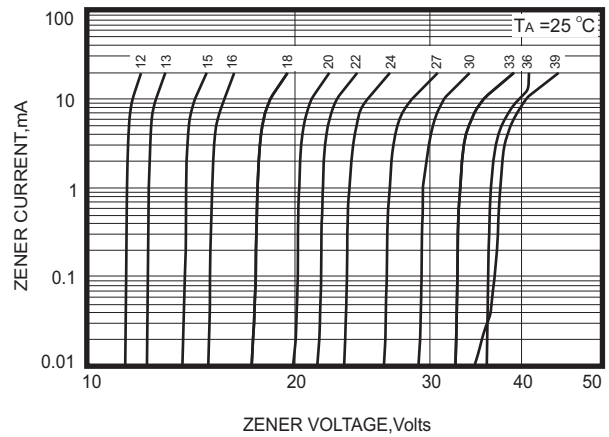
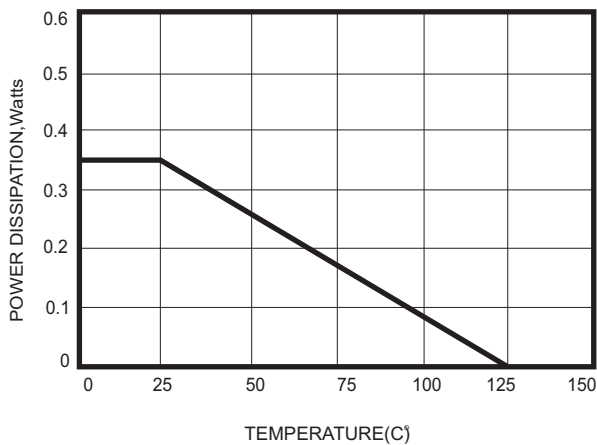
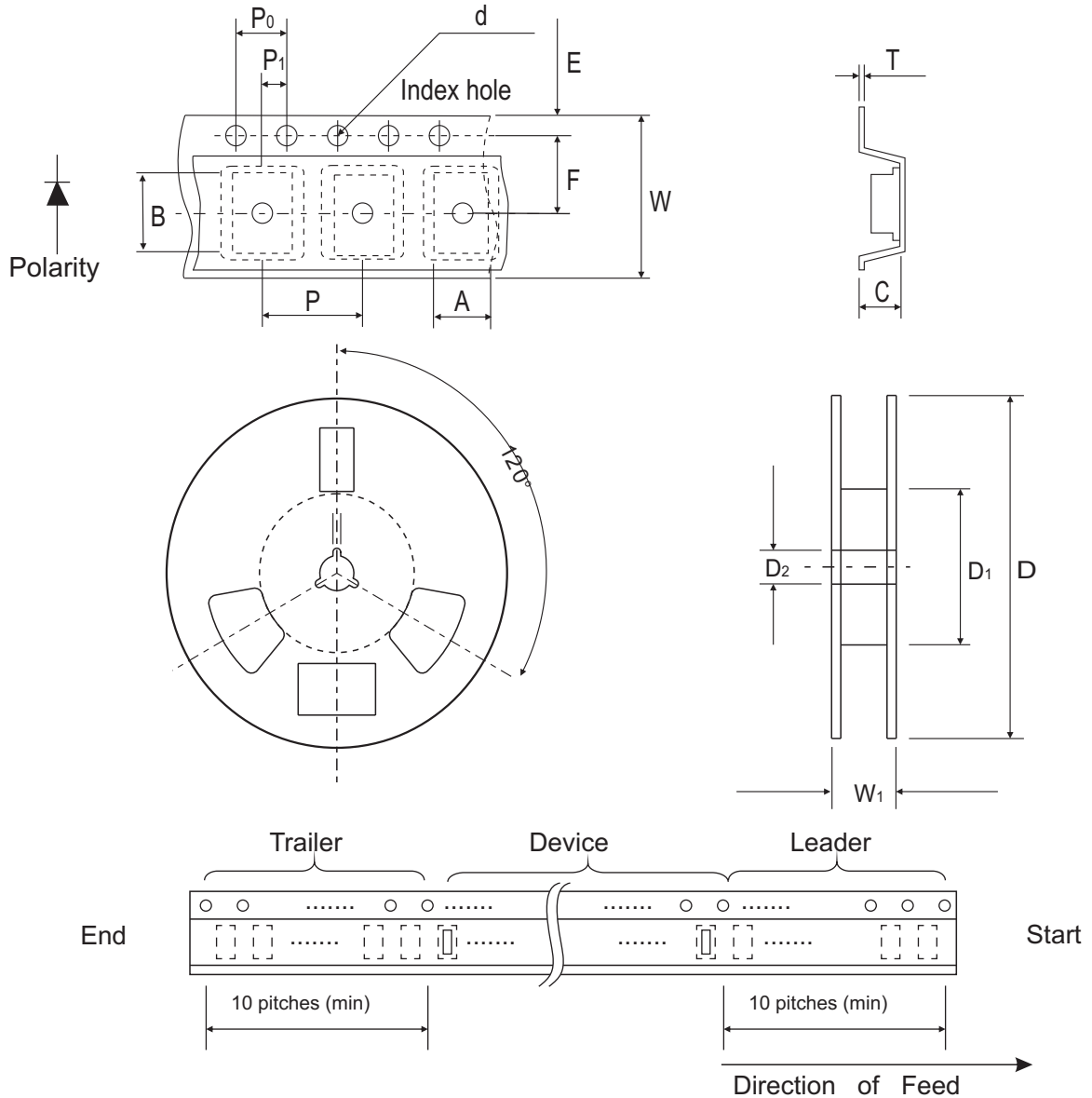

Fig.9 STEADY STATE POWER DERATING



Reel Taping Specification



| 1005 (SOD-323F) | SYMBOL | A | B | C | d | D | D ₁ | D ₂ |
|--------------------|--------|---------------|---------------|---------------|---------------|--------------|----------------|----------------|
| | (mm) | 1.55 ± 0.10 | 2.65 ± 0.10 | 1.05 ± 0.10 | 1.55 ± 0.05 | 178 ± 1 | 60.0 MIN. | 13.0 ± 0.20 |
| | (inch) | 0.061 ± 0.004 | 0.104 ± 0.004 | 0.041 ± 0.004 | 0.061 ± 0.002 | 7.008 ± 0.04 | 2.362 MIN. | 0.512 ± 0.008 |

| 1005 (SOD-323F) | SYMBOL | E | F | P | P ₀ | P ₁ | T | W | W ₁ |
|--------------------|--------|---------------|---------------|---------------|----------------|----------------|---------------|---------------|----------------|
| | (mm) | 1.75 ± 0.10 | 3.50 ± 0.05 | 4.00 ± 0.10 | 4.00 ± 0.10 | 2.00 ± 0.05 | 0.23 ± 0.05 | 8.00 ± 0.20 | 13.5 MAX. |
| | (inch) | 0.069 ± 0.004 | 0.138 ± 0.002 | 0.157 ± 0.004 | 0.157 ± 0.004 | 0.079 ± 0.002 | 0.009 ± 0.002 | 0.315 ± 0.008 | 0.531 MAX. |

Company reserves the right to improve product design, functions and reliability without notice.

REV:B