

## CZRQC2V4B-HF Thru CZRQC39VB-HF

High-Reliability and High-Performance

Voltage 2.4 to 39 Volts

Power 125 mWatts

RoHS Device

Halogen Free

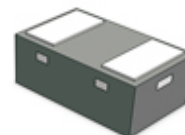

### Features

- 125mW Power Dissipation.
- High Voltages from 2.4 ~ 39 V.
- Designed for mounting on small surface.
- Extremely thin/leadless package.
- Constant voltage control.
- Pb free product.

### Mechanical data

- Case: 0402C/SOD-923F Standard package  
Molded plastic.
- Terminals: Gold plated, solderable per MIL-STD-750,method 2026.
- Polarity: Indicated by cathode band.
- Weight: 0.001 grams (approx.).

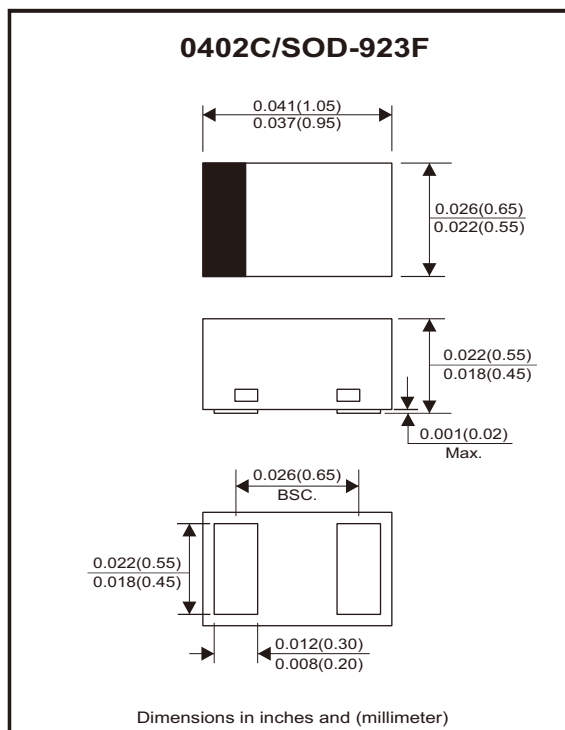

### Circuit Diagram



### Maximum Rating and Electrical Characteristics

Parameter	Symbol	Value	Unit
Maximum forward voltage drop at $I_F = 10 \text{ mA}$	$V_F$	0.9	V
Maximum power dissipation at 25 °C	$P_D$	125	mW
Forward current , surge peak 8.3 ms single half sine-wave superimposed on rate load( JEDEC method )	$I_{FSM}$	2.0	A
Peak ESD voltage capability (IEC 61000-4-2)	$V_{PV}$	8	kV
Operating junction and storage temperature range	$T_J$	-55 to +125	°C

## Electrical Characteristics (at Ta = 25°C unless otherwise noted)

Part Number	Marking Code	Zener Voltage			Operating resistance		Rising operating Resistance		Reverse current	
		V <sub>Z</sub> (V)			Z <sub>ZT</sub> (Ohm)		Z <sub>ZK</sub> (Ohm)		I <sub>R</sub> (μA)	
		Min	Max	I <sub>Z</sub> (mA)	Max	I <sub>Z</sub> (mA)	Max	I <sub>Z</sub> (mA)	Max	V <sub>R</sub> (V)
CZRQC2V4B-HF	U2	2.34	2.46	5	100	5	1800	0.25	100	1
CZRQC2V7B-HF	U3	2.63	2.77	5	100	5	1900	0.25	75	1
CZRQC3V0B-HF	U4	2.93	3.08	5	95	5	2000	0.25	50	1
CZRQC3V3B-HF	U5	3.22	3.38	5	95	5	2200	0.25	25	1
CZRQC3V6B-HF	U6	3.51	3.69	5	90	5	2300	0.25	15	1
CZRQC3V9B-HF	U7	3.80	4.00	5	90	5	2400	0.25	10	1
CZRQC4V3B-HF	U8	4.19	4.41	5	88	5	2500	0.25	5	1
CZRQC4V7B-HF	U9	4.58	4.82	5	70	5	2200	0.25	3	1.5
CZRQC5V1B-HF	UA	4.97	5.23	5	50	5	2050	0.25	2	2
CZRQC5V6B-HF	UB	5.46	5.74	5	25	5	1800	0.25	2	3
CZRQC6V2B-HF	UC	6.05	6.36	5	10	5	1300	0.25	1	4
CZRQC6V8B-HF	UE	6.63	6.97	5	8	5	750	0.25	1	5.2
CZRQC7V5B-HF	UF	7.31	7.69	5	7	5	600	0.25	0.5	6
CZRQC8V2B-HF	UG	8.00	8.41	5	7	5	600	0.25	0.5	6.5
CZRQC9V1B-HF	UH	8.87	9.33	5	10	5	600	0.25	0.1	7
CZRQC10VB-HF	UJ	9.75	10.25	5	15	5	600	0.25	0.1	8
CZRQC11VB-HF	UK	10.73	11.27	5	18	5	600	0.25	0.1	8.4
CZRQC12VB-HF	UM	11.70	12.30	5	22	5	600	0.25	0.1	9.1
CZRQC13VB-HF	UN	12.68	13.32	5	25	5	600	0.25	0.1	9.9
CZRQC15VB-HF	UP	14.63	15.37	5	32	5	600	0.25	0.1	11
CZRQC16VB-HF	UQ	15.60	16.40	5	36	5	600	0.25	0.1	12
CZRQC18VB-HF	UR	17.55	18.45	5	42	5	600	0.25	0.1	14
CZRQC20VB-HF	US	19.50	20.50	5	48	5	600	0.25	0.1	15
CZRQC22VB-HF	UT	21.45	22.55	5	55	5	600	0.25	0.1	17
CZRQC24VB-HF	UU	23.40	24.60	5	62	5	600	0.25	0.1	18
CZRQC27VB-HF	UV	26.33	27.67	5	70	5	600	0.25	0.1	21
CZRQC30VB-HF	UW	29.25	30.75	5	78	5	600	0.25	0.1	23
CZRQC33VB-HF	UX	32.18	33.82	5	88	5	700	0.25	0.1	25
CZRQC36VB-HF	UY	35.10	36.90	5	95	5	700	0.25	0.1	27
CZRQC39VB-HF	UZ	38.03	39.97	5	130	5	800	0.25	0.1	30

## Rating and Characteristic Curves (CZRQC2V4B-HF Thru. CZRQC39VB-HF)

Fig.1 - Zener Voltage Characteristics

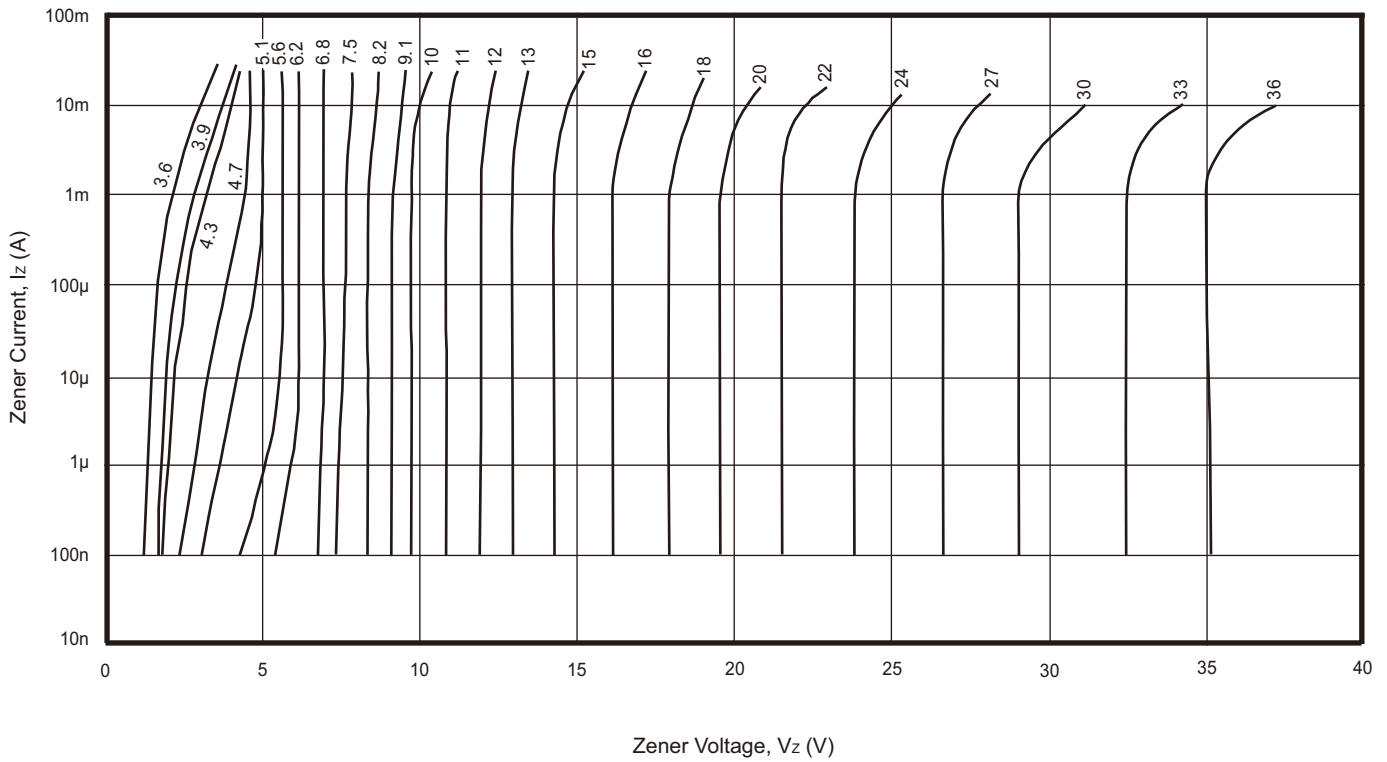

Fig.2 - Derating Curve

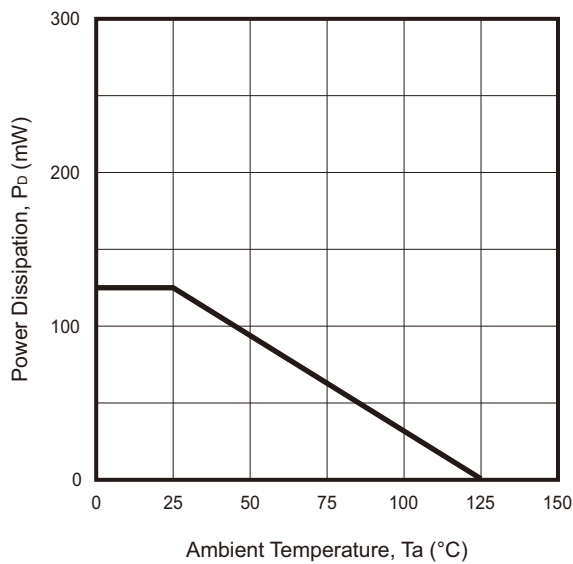
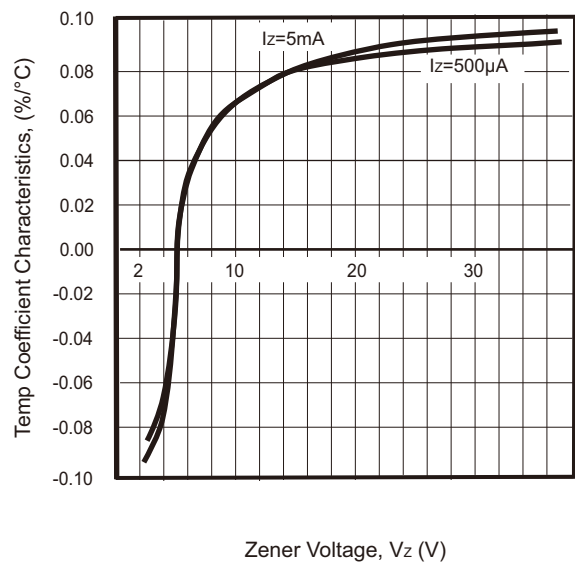
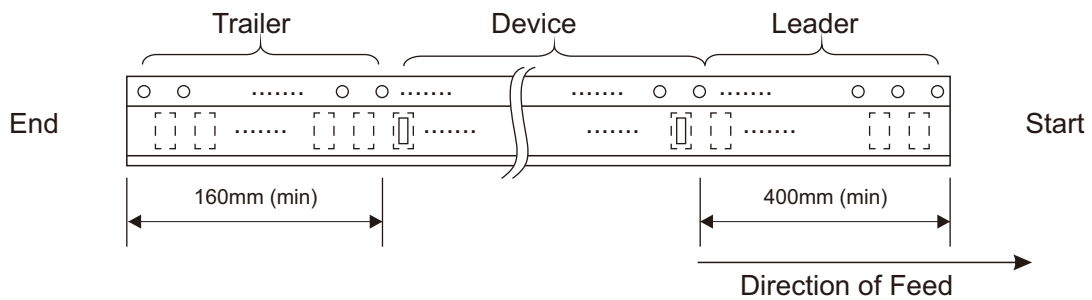
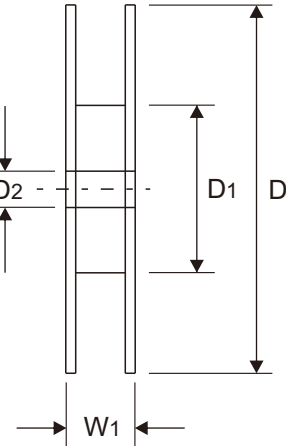
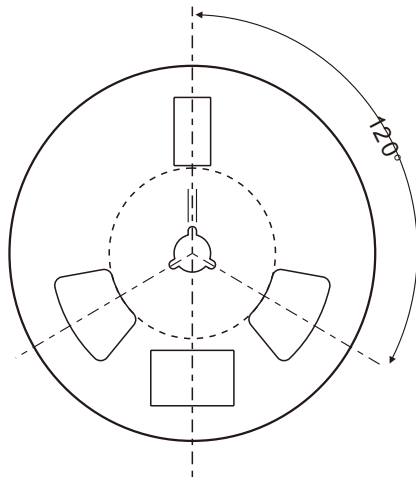
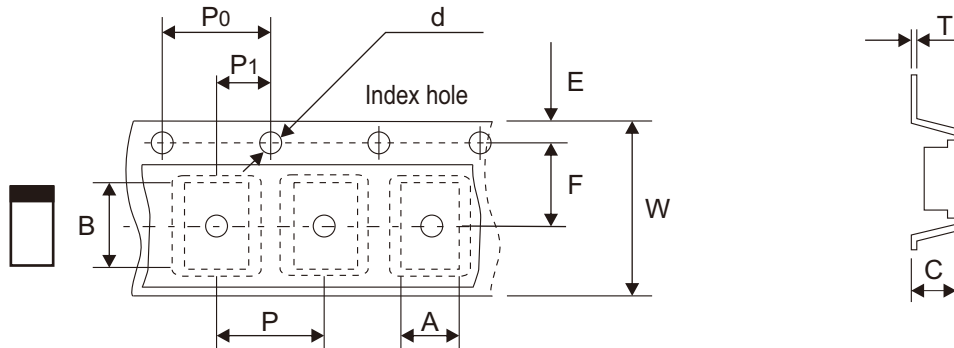

Fig.3 - Zener Voltage-Temp. Coefficient Characteristics



## Reel Taping Specification



0402C (SOD-923F)	SYMBOL	A	B	C	d	D	D1	D2
	(mm)	0.75 ± 0.05	1.17 ± 0.05	0.65 ± 0.05	1.50 + 0.10 - 0.00	178.00 ± 1.00	60.00 ± 0.50	13.50 ± 0.20
	(inch)	0.030 ± 0.002	0.046 ± 0.002	0.026 ± 0.002	0.059 + 0.004 - 0.000	7.008 ± 0.039	2.362 ± 0.020	0.531 ± 0.008

0402C (SOD-923F)	SYMBOL	E	F	P	P0	P1	T	W	W1
	(mm)	1.75 ± 0.10	3.50 ± 0.10	4.00 ± 0.10	4.00 ± 0.10	2.00 ± 0.10	0.20 + 0.02 - 0.05	8.00 ± 0.20	12.00 + 0.50 - 0.00
	(inch)	0.069 ± 0.004	0.138 ± 0.004	0.157 ± 0.004	0.157 ± 0.004	0.079 ± 0.004	0.008 + 0.001 - 0.002	0.315 ± 0.008	0.472 + 0.020 - 0.000

Company reserves the right to improve product design , functions and reliability without notice.

REV:B