

## CZRT5222B-G Thru. CZRT5256B-G

Voltage: 2.5 to 30 Volts

Power: 300 mWatts

RoHS Device

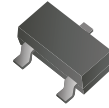

### Features

- Planar die construction.
- 300mW power dissipation on FR-4 PCB.
- Ideally suited for automated assembly process.
- General purpose, medium current.

### Mechanical data

- Case: SOT-23, Molded plastic.
- Terminals: Solderable per MIL-STD-202G, method 208.
- Polarity: See diagram below.
- Mounting position: Any
- Marking: see table on page 2.
- Weight: 0.0078 gram (approx.).

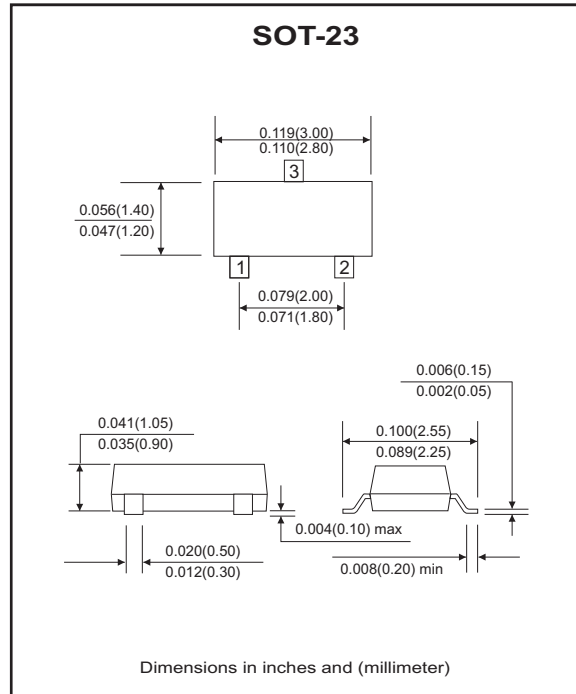
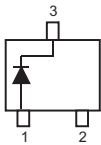

### Electrical Characteristics (TA=25°C, unless otherwise specified)

Parameter	Symbol	Value	Unit
Forward voltage drop at $I_F=10\text{mA}$	V <sub>F</sub>	0.9	V
Power dissipation (Notes A), $T_A = 25^\circ\text{C}$	P <sub>D</sub>	300	mW
Thermal resistance, junction to ambient air (Notes A)	R <sub>θJA</sub>	417	°C/W
Operating junction and storage temperature range	T <sub>J</sub>	-65 to +150	°C

## Electrical Characteristics(@Ta = 25°C unless otherwise specified)

Part Number	Zener Voltage			Operating Resistance		Rising Operating Resistance		Reverse Current		Marking Code
	VZ(V)@IZT			ZZT(Ohm)		ZZK(Ohm)		IR(uA)		
	Min.	Nom.	Max.	Max.	IZT(mA)	Max.	IZK(mA)	Max.	VR(V)	
CZRT5222B-G	2.38	2.5	2.63	30	20.0	1250	0.25	100	1.0	KC2
CZRT5223B-G	2.57	2.7	2.84	30	20.0	1300	0.25	75	1.0	KC3
CZRT5225B-G	2.85	3.0	3.15	30	20.0	1600	0.25	50	1.0	KC5
CZRT5226B-G	3.14	3.3	3.47	28	20.0	1600	0.25	25	1.0	KG1
CZRT5227B-G	3.42	3.6	3.78	24	20.0	1700	0.25	15	1.0	KG2
CZRT5228B-G	3.71	3.9	4.10	23	20.0	1900	0.25	10	1.0	KG3
CZRT5229B-G	4.09	4.3	4.52	22	20.0	2000	0.25	5.0	1.0	KG4
CZRT5230B-G	4.47	4.7	4.94	19	20.0	1900	0.25	5.0	2.0	KG5
CZRT5231B-G	4.85	5.1	5.36	17	20.0	1600	0.25	5.0	2.0	KE1
CZRT5232B-G	5.32	5.6	5.88	11	20.0	1600	0.25	5.0	3.0	KE2
CZRT5233B-G	5.70	6.0	6.30	17	20.0	1600	0.25	5.0	2.0	KE3
CZRT5234B-G	5.89	6.2	6.51	7	20.0	1000	0.25	5.0	4.0	KE4
CZRT5235B-G	6.46	6.8	7.14	5	20.0	750	0.25	3.0	5.0	KE5
CZRT5236B-G	7.13	7.5	7.88	6	20.0	500	0.25	3.0	6.0	KF1
CZRT5237B-G	7.79	8.2	8.61	8	20.0	600	0.25	3.0	6.5	KF2
CZRT5238B-G	8.27	8.7	9.14	8	20.0	600	0.25	3.0	6.5	KF3
CZRT5239B-G	8.65	9.1	9.56	10	20.0	600	0.25	3.0	7.0	KF4
CZRT5240B-G	9.50	10	10.50	17	20.0	600	0.25	3.0	8.0	KF5
CZRT5241B-G	10.45	11	11.55	22	20.0	600	0.25	2.0	8.4	KH1
CZRT5242B-G	11.40	12	12.60	30	20.0	600	0.25	1.0	9.1	KH2
CZRT5243B-G	12.35	13	13.65	13	9.5	600	0.25	0.5	9.9	KH3
CZRT5244B-G	13.30	14	14.70	15	9.0	600	0.25	0.1	10	KH4
CZRT5245B-G	14.25	15	15.75	16	8.5	600	0.25	0.1	11	KH5
CZRT5246B-G	15.20	16	16.80	17	7.8	600	0.25	0.1	12	KJ1
CZRT5247B-G	16.15	17	17.85	19	7.4	600	0.25	0.1	13	KJ2
CZRT5248B-G	17.10	18	18.90	21	7.0	600	0.25	0.1	14	KJ3
CZRT5249B-G	18.05	19	19.95	23	6.6	600	0.25	0.1	14	KJ2
CZRT5250B-G	19.00	20	21.00	25	6.2	600	0.25	0.1	15	KJ5
CZRT5251B-G	20.90	22	23.10	29	5.6	600	0.25	0.1	17	KK1
CZRT5252B-G	22.80	24	25.20	33	5.2	600	0.25	0.1	18	KK2
CZRT5253B-G	23.75	25	26.25	35	5.0	600	0.25	0.1	19	KK3
CZRT5254B-G	25.65	27	28.35	41	5.0	600	0.25	0.1	21	KK4
CZRT5255B-G	26.60	28	29.40	44	4.5	600	0.25	0.1	21	KK5
CZRT5256B-G	28.50	30	31.50	49	4.2	600	0.25	0.1	23	KM1

Notes:

1. Short duration test pulse used to minimize self-heating effect.
2. f=1KHz.
3. 5% Standard Vz Tolerance

## RATING AND CHARACTERISTIC CURVES (CZRT5222B-G Thru CZRT5256B-G )

Fig.1- Power Derating Curve

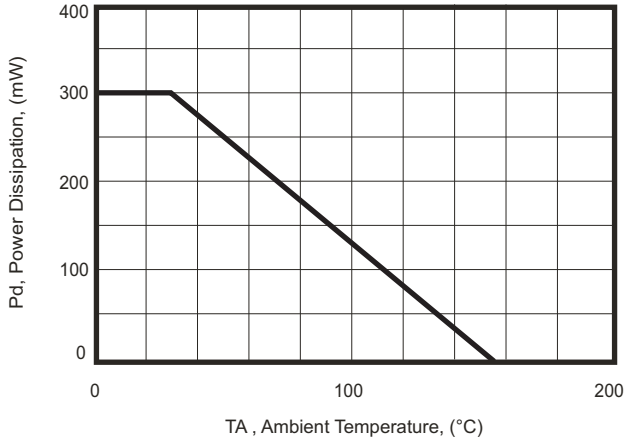

Fig.2- Maximum Non-repetitive Surge Power

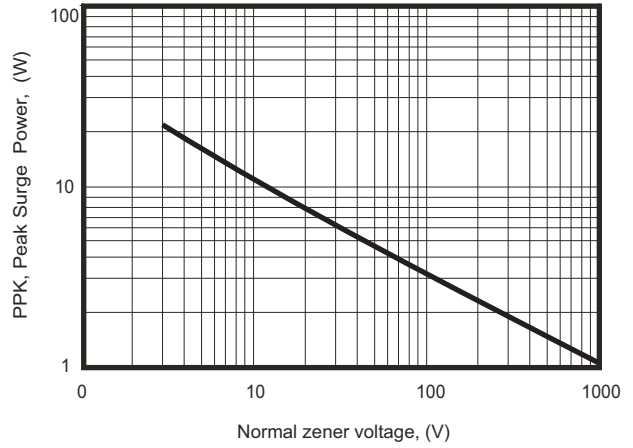

Fig.3- Zener Voltage vs Zener Impedance

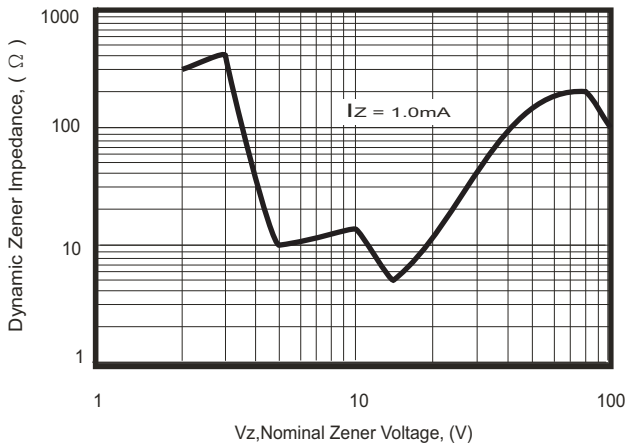

Fig.4- Total Capacitance vs Nominal Zener Voltage

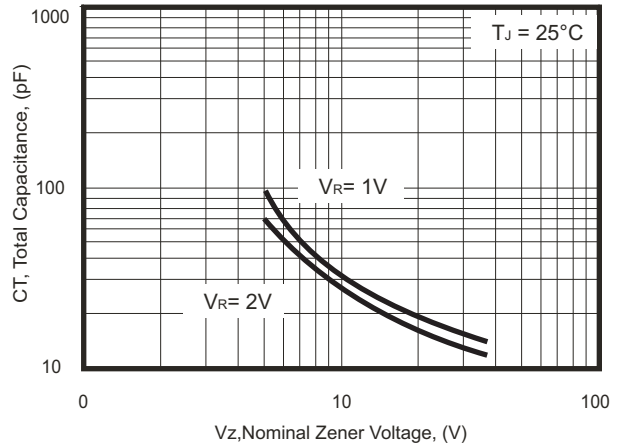

Fig.5- Zener Breakdown Characteristics

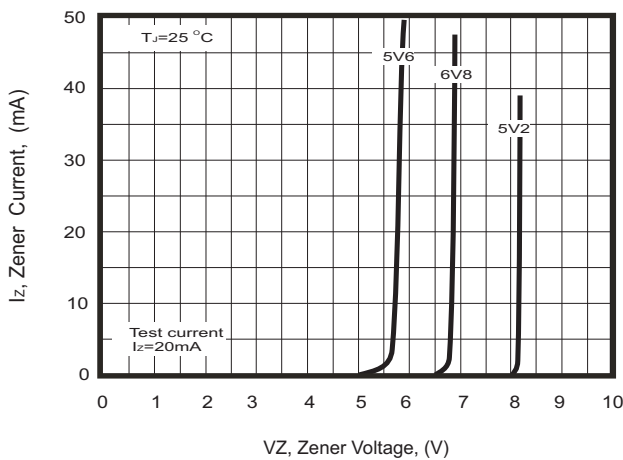
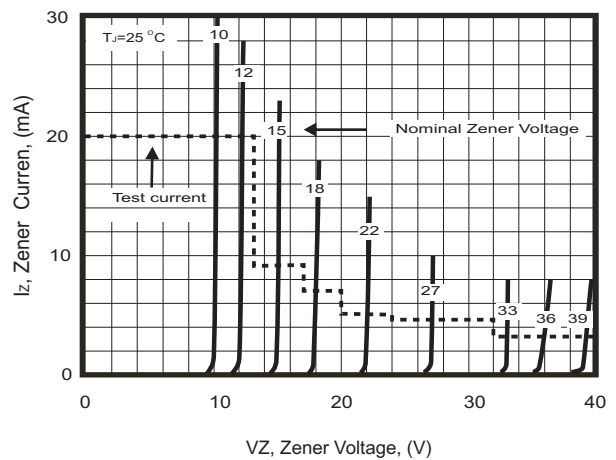
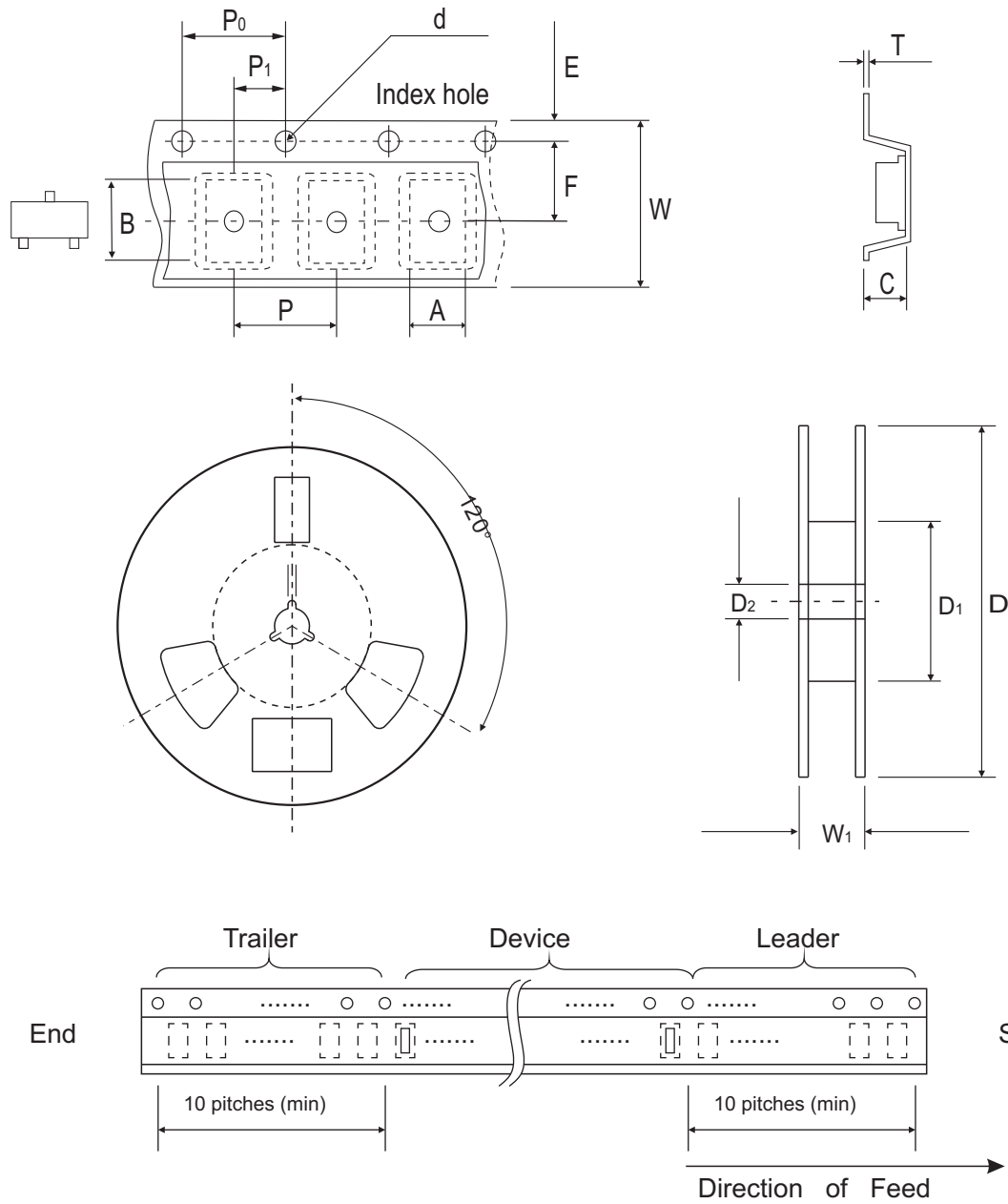

Fig.6- Zener Breakdown Characteristics



## Reel Taping Specification



SOT-23	SYMBOL	A	B	C	d	D	D1	D2
	(mm)	3.15 ± 0.10	2.77 ± 0.10	1.22 ± 0.10	1.50 ± 0.10	178 ± 1.00	54.40 ± 0.40	13.00 ± 0.20
	(inch)	0.124 ± 0.004	0.109 ± 0.004	0.048 ± 0.004	0.059 ± 0.004	7.008 ± 0.039	2.142 ± 0.016	0.512 ± 0.008

SOT-23	SYMBOL	E	F	P	P0	P1	W	W1
	(mm)	1.75 ± 0.10	3.50 ± 0.05	4.00 ± 0.10	4.00 ± 0.10	2.00 ± 0.10	8.00 ± 0.30 / - 0.10	9.50 ± 1.00
	(inch)	0.069 ± 0.004	0.138 ± 0.002	0.157 ± 0.004	0.157 ± 0.004	0.079 ± 0.004	0.315 ± 0.012 / - 0.004	0.374 ± 0.039