

## CZRT55C2V4-G Thru CZRT55C39-G

Voltage: 2.4 to 39 Volts

Power: 350 mWatts

RoHS Device



### Features

- Planar die construction
- 350mW power dissipation
- Ideally suited for automated assembly process
- Pb free product are available : 99% Sn above can meet RoHS

### Mechanical data

- Case: SOT-23, Molded plastic
- Terminals: Solderable per MIL-STD-202G, method 208
- Polarity: See diagram below
- Weight: 0.008 gram(approx.)
- Mounting position: Any

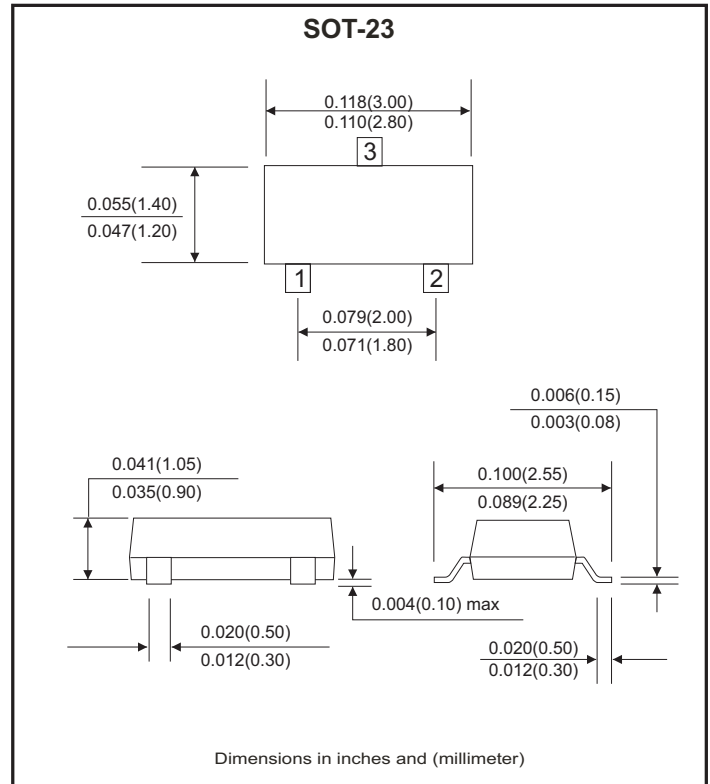
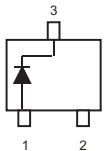

### Maximum Rating And Electrical Characteristics

Parameter	Symbol	Value	Unit
Forward Voltage (Notes 2) @ IF=10mA	V <sub>F</sub>	0.9	V
Power Dissipation (Notes 1)	P <sub>d</sub>	350	mW
Thermal Resistance, Junction to Ambient Air	R <sub>θJA</sub>	357	°C/W
Operating junction and Storage Temperature Range	T <sub>J</sub>	-65 to +150	°C

Notes:

1. Valid provided that device terminals are kept at ambient temperature.
2. Tested with pulses, period=5ms, pulse width=300us.
3. f=1KHz

## Electrical Characteristics(Ta = 25°C)

Part Number	Zener Voltage			Operating Resistance		Rising Operating Resistance		Reverse Current		Marking Code
	V <sub>Z</sub> (V)@I <sub>ZT</sub>			Z <sub>OT</sub> (Ohm)		Z <sub>OK</sub> (Ohm)		I <sub>R</sub> (uA)		
	Min.	Nom.	Max.	Max.	I <sub>ZT</sub> (mA)	Max.	I <sub>ZK</sub> (mA)	Max.	V <sub>R</sub> (V)	
CZRT55C2V4	2.2	2.4	2.6	100	5.0	600	1.0	50	1	Z11
CZRT55C2V7	2.5	2.7	2.9	100	5.0	600	1.0	20	1	Z12
CZRT55C3	2.8	3.0	3.2	95	5.0	600	1.0	10	1	Z13
CZRT55C3V3	3.1	3.3	3.5	95	5.0	600	1.0	5.0	1	Z14
CZRT55C3V6	3.4	3.6	3.8	90	5.0	600	1.0	5.0	1	Z15
CZRT55C3V9	3.7	3.9	4.1	90	5.0	600	1.0	3.0	1	Z16
CZRT55C4V3	4.0	4.3	4.6	90	5.0	600	1.0	3.0	1	Z17
CZRT55C4V7	4.4	4.7	5.0	80	5.0	500	1.0	3.0	2	Z1
CZRT55C5V1	4.8	5.1	5.4	60	5.0	480	1.0	2.0	2	Z2
CZRT55C5V6	5.2	5.6	6.0	40	5.0	400	1.0	1.0	2	Z3
CZRT55C6V2	5.8	6.2	6.6	10	5.0	150	1.0	3.0	4	Z4
CZRT55C6V8	6.4	6.8	7.2	15	5.0	80	1.0	2.0	4	Z5
CZRT55C7V5	7.0	7.5	7.9	15	5.0	80	1.0	1.0	5	Z6
CZRT55C8V2	7.7	8.2	8.7	15	5.0	80	1.0	0.7	5	Z7
CZRT55C9V1	8.5	9.1	9.6	15	5.0	100	1.0	0.5	6	Z8
CZRT55C10	9.4	10	10.6	20	5.0	150	1.0	0.2	7	Z9
CZRT55C11	10.4	11	11.6	20	5.0	150	1.0	0.1	8	Y1
CZRT55C12	11.4	12	12.7	25	5.0	150	1.0	0.1	8	Y2
CZRT55C13	12.4	13	14.1	30	5.0	170	1.0	0.1	8	Y3
CZRT55C15	13.8	15	15.6	30	5.0	200	1.0	0.1	10.5	Y4
CZRT55C16	15.3	16	17.1	40	5.0	200	1.0	0.1	11.2	Y5
CZRT55C18	16.8	18	19.1	45	5.0	225	1.0	0.1	12.6	Y6
CZRT55C20	18.8	20	21.2	55	5.0	225	1.0	0.1	14.0	Y7
CZRT55C22	20.8	22	23.3	55	5.0	250	1.0	0.1	15.4	Y8
CZRT55C24	22.8	24	25.6	70	5.0	250	1.0	0.1	16.8	Y9
CZRT55C27	25.1	27	28.9	80	2.0	300	0.5	0.1	18.9	Y10
CZRT55C30	28.0	30	32.0	80	2.0	300	0.5	0.1	21.0	Y11
CZRT55C33	31.0	33	35.0	80	2.0	325	0.5	0.1	23.1	Y12
CZRT55C36	34.0	36	38.0	90	2.0	350	0.5	0.1	25.2	Y13
CZRT55C39	37.0	39	41.0	130	2.0	350	0.5	0.1	27.3	Y14

## RATING AND CHARACTERISTIC CURVES (CZRT55C2V4-G Thru CZRT55C39-G)

Fig.1- Power Derating Curve

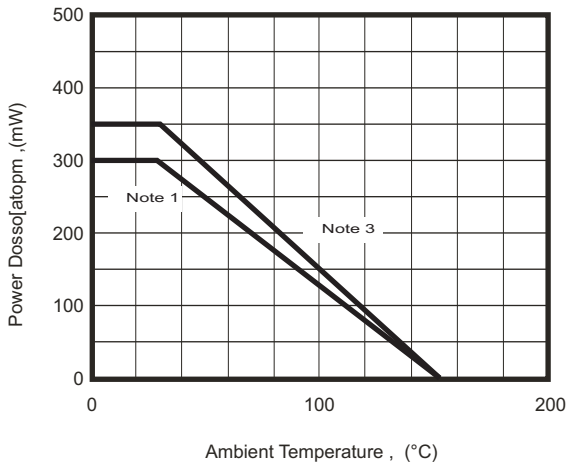

Fig.2- Zener Breakdown Characteristics

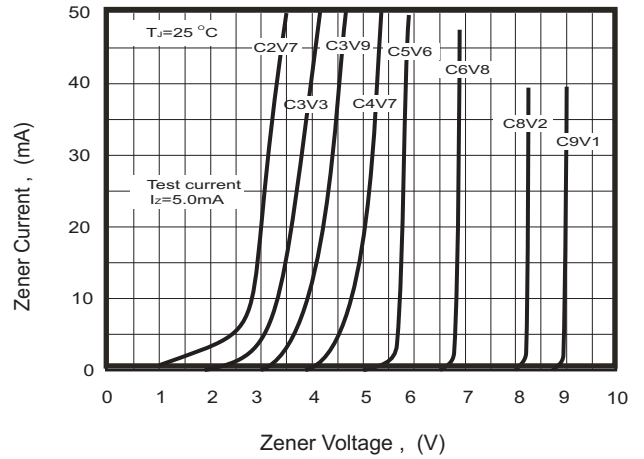

Fig.3- Zener Breakdown Characteristics

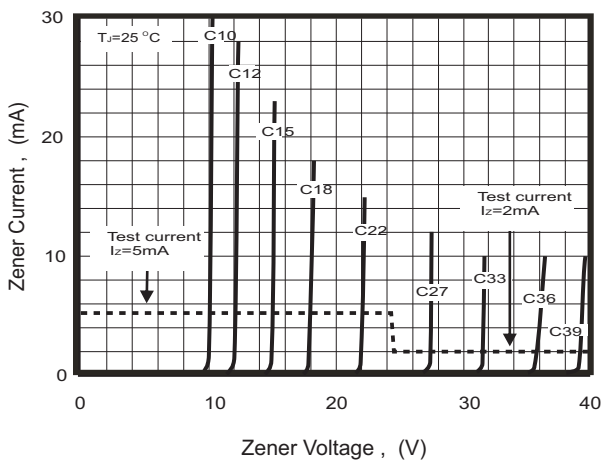
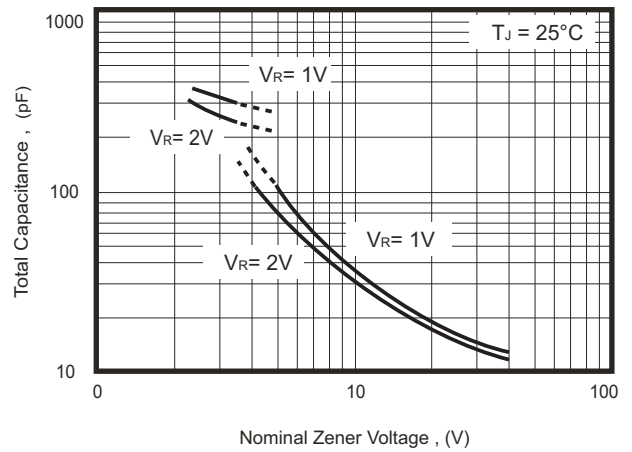
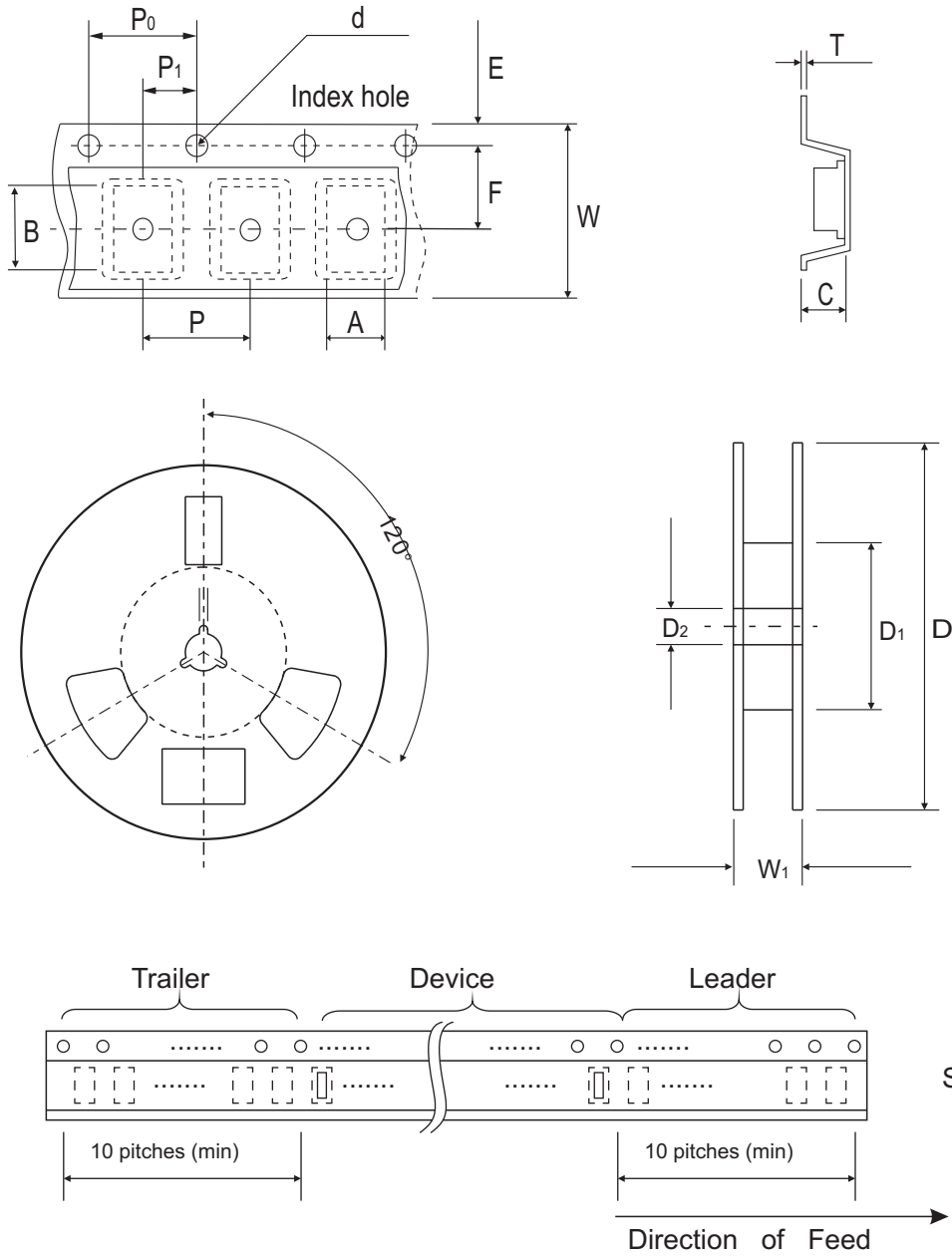

Fig.4- Total Capacitance vs Nominal Zener Voltage



## Reel Taping Specification



SOT-23	SYMBOL	A	B	C	d	D	D1	D2
	(mm)	3.15 ± 0.10	2.77 ± 0.10	1.22 ± 0.10	1.50 ± 0.10	178 ± 1.00	54.40 ± 0.40	13.00 ± 0.20
	(inch)	0.124 ± 0.004	0.109 ± 0.004	0.048 ± 0.004	0.059 ± 0.004	7.008 ± 0.039	2.142 ± 0.016	0.512 ± 0.008

SOT-23	SYMBOL	E	F	P	P0	P1	W	W1
	(mm)	1.75 ± 0.10	3.50 ± 0.05	4.00 ± 0.10	4.00 ± 0.10	2.00 ± 0.10	8.00 + 0.30 / - 0.10	9.50 ± 1.00
	(inch)	0.069 ± 0.004	0.138 ± 0.002	0.158 ± 0.004	0.158 ± 0.004	0.079 ± 0.004	0.315 + 0.012 / - 0.004	0.374 ± 0.039