

## CZRW55C2V4-G Thru CZRW55C39-G

Voltage: 2.4 to 39 Volts

Power: 500 mWatts

RoHS Device

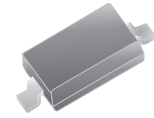

### Features

- Planar die construction.
- 500mW power dissipation.
- Ideally suited for automated assembly process.
- Ultra small surface mount package.

### Mechanical data

- Case: SOD-123, Molded plastic
- Terminals: Solderable per MIL-STD-202G, method 208
- Polarity: Indicated by cathode band.
- Mounting position: Any

Marking: see table on page2

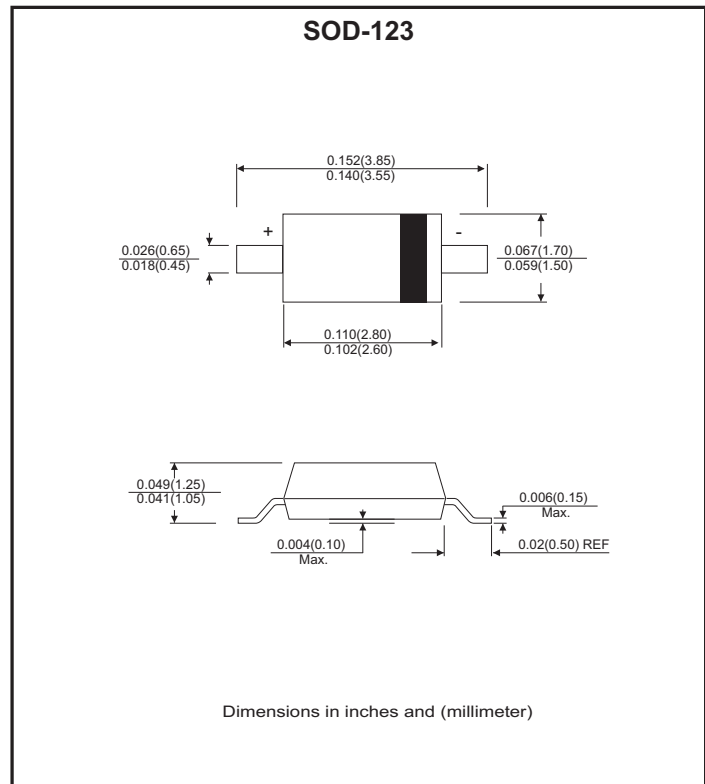

### Maximum Ratings (TA=25°C, unless otherwise specified)

Parameter	Symbol	Value	Unit
Forward voltage at IF=10mA (Note 2)	V <sub>F</sub>	0.9	V
Power dissipation (Note 1)	P <sub>D</sub>	500	mW
Thermal resistance, junction to ambient air	R <sub>θJA</sub>	250	°C/W
Operating junction and storage temperature range	T <sub>J</sub> , T <sub>STG</sub>	-65 to +150	°C

Note:

1. Device mounted on ceramic PCB: 7.6mm×9.4mm×0.87mm with pad area 25mm<sup>2</sup>
2. Short duration test pulse used to minimize self-heating effect.
3. When provided, otherwise, parts are provided with date code only, and type number identifications appears on reel only.
4. f=1KHz

## Electrical Characteristics(Ta = 25°C)

Part No.	Nom in al Zener Voltage			Max. Zener Impedence				Max. Reverse Leakage Current		Temperature Coefficient of Zrener Voltage @IZT=5mA (mV/°C)		Marking Code
	VZ @ IZT			ZZT @ IZT		ZZK @ IZK		IR @ VR		Min.	Max.	
	Nom.	Min.	Max.	ohm	mA	ohm	mA	uA	V			
CZRW55C2V4-G	2.4	2.20	2.60	100	5.0	600	1.00	50.0	1.0	-3.5	0.0	WX
CZRW55C2V7-G	2.7	2.50	2.90	100	5.0	600	1.00	20.0	1.0	-3.5	0.0	W1
CZRW55C3V0-G	3.0	2.80	3.20	95	5.0	600	1.00	10.0	1.0	-3.5	0.0	W2
CZRW55C3V3-G	3.3	3.10	3.50	95	5.0	600	1.00	5.0	1.0	-3.5	0.0	W3
CZRW55C3V6-G	3.6	3.40	3.80	90	5.0	600	1.00	5.0	1.0	-3.5	0.0	W4
CZRW55C3V9-G	3.9	3.70	4.10	90	5.0	600	1.00	3.0	1.0	-3.5	0.0	W5
CZRW55C4V3-G	4.3	4.00	4.60	90	5.0	600	1.00	3.0	1.0	-3.5	0.0	W6
CZRW55C4V7-G	4.7	4.40	5.00	80	5.0	500	1.00	3.0	2.0	-3.5	0.2	W7
CZRW55C5V1-G	5.1	4.80	5.40	60	5.0	480	1.00	2.0	2.0	-2.7	1.2	W8
CZRW55C5V6-G	5.6	5.20	6.00	40	5.0	400	1.00	1.0	2.0	-2.0	2.5	W9
CZRW55C6V2-G	6.2	5.80	6.60	10	5.0	150	1.00	3.0	4.0	0.4	3.7	WA
CZRW55C6V8-G	6.8	6.40	7.20	15	5.0	80	1.00	2.0	4.0	1.2	4.5	WB
CZRW55C7V5-G	7.5	7.00	7.90	15	5.0	80	1.00	1.0	5.0	2.5	5.3	WC
CZRW55C8V2-G	8.2	7.70	8.70	15	5.0	80	1.00	0.7	5.0	3.2	6.2	WD
CZRW55C9V1-G	9.1	8.50	9.60	15	5.0	100	1.00	0.5	6.0	3.8	7.0	WE
CZRW55C10-G	10.0	9.40	10.60	20	5.0	150	1.00	0.2	7.0	4.5	8.0	WF
CZRW55C11-G	11.0	10.40	11.60	20	5.0	150	1.00	0.1	8.0	5.4	9.0	WG
CZRW55C12-G	12.0	11.40	12.70	25	5.0	150	1.00	0.1	8.0	6.0	10.0	WH
CZRW55C13-G	13.0	12.40	14.10	30	5.0	170	1.00	0.1	8.0	7.0	11.0	WI
CZRW55C15-G	15.0	13.80	15.60	30	5.0	200	1.00	0.1	10.5	9.2	13.0	WJ
CZRW55C16-G	16.0	15.30	17.10	40	5.0	200	1.00	0.1	11.2	10.4	14.0	WK
CZRW55C18-G	18.0	16.80	19.10	45	5.0	225	1.00	0.1	12.6	12.4	16.0	WL
CZRW55C20-G	20.0	18.80	21.20	55	5.0	225	1.00	0.1	14.0	14.4	18.0	WM
CZRW55C22-G	22.0	20.80	23.30	55	5.0	250	1.00	0.1	15.4	16.4	20.0	WN
CZRW55C24-G	24.0	22.80	25.60	70	5.0	250	1.00	0.1	16.8	18.4	22.0	WO
CZRW55C27-G	27.0	25.10	28.90	80	2.0	300	0.50	0.1	18.9	21.4	25.3	WP
CZRW55C30-G	30.0	28.00	32.00	80	2.0	300	0.50	0.1	21.0	24.4	29.4	WQ
CZRW55C33-G	33.0	31.00	35.00	80	2.0	325	0.50	0.1	23.1	27.4	33.4	WR
CZRW55C36-G	36.0	34.00	38.00	90	2.0	350	0.50	0.1	25.2	30.4	37.4	WS
CZRW55C39-G	39.0	37.00	41.00	130	2.0	350	0.50	0.1	27.3	33.4	41.2	WT

## Ratings and Characteristic Curves(CZRW55C2V4-G Thru. CZRW55C39-G)

Fig.1 Power Dissipation Derating Curve

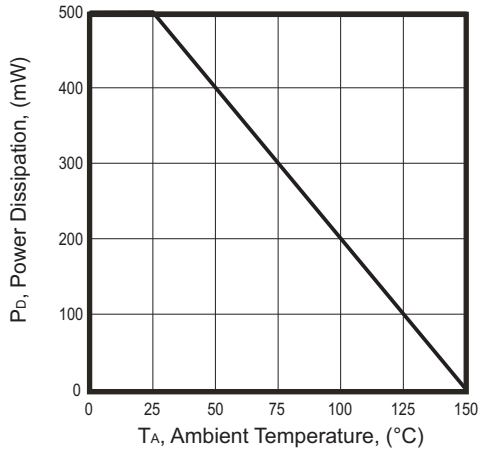

Fig.2 Zener Breakdown Characteristics

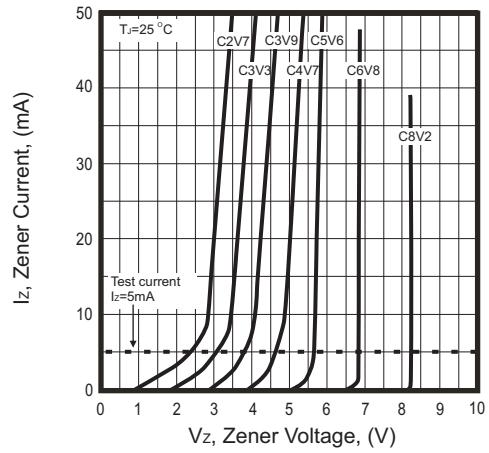

Fig.3 Zener Breakdown Characteristics

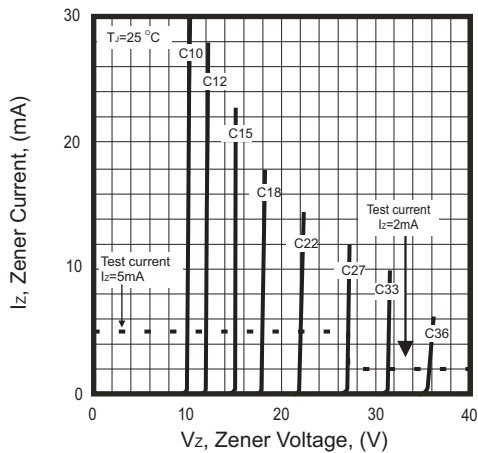

Fig.4 Zener Breakdown Characteristics

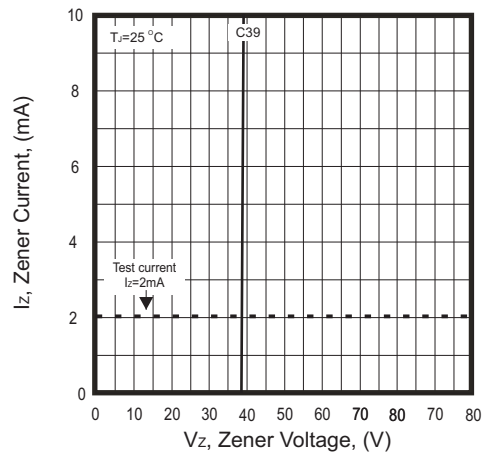
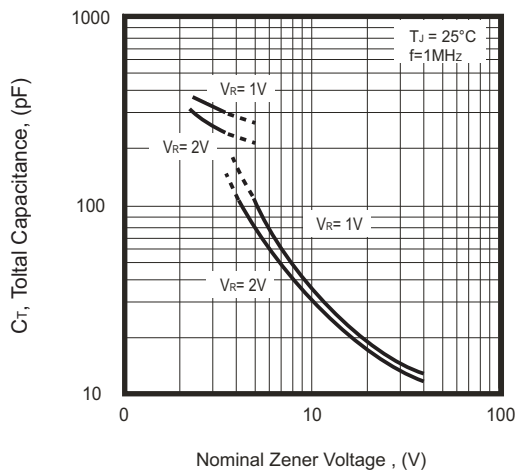
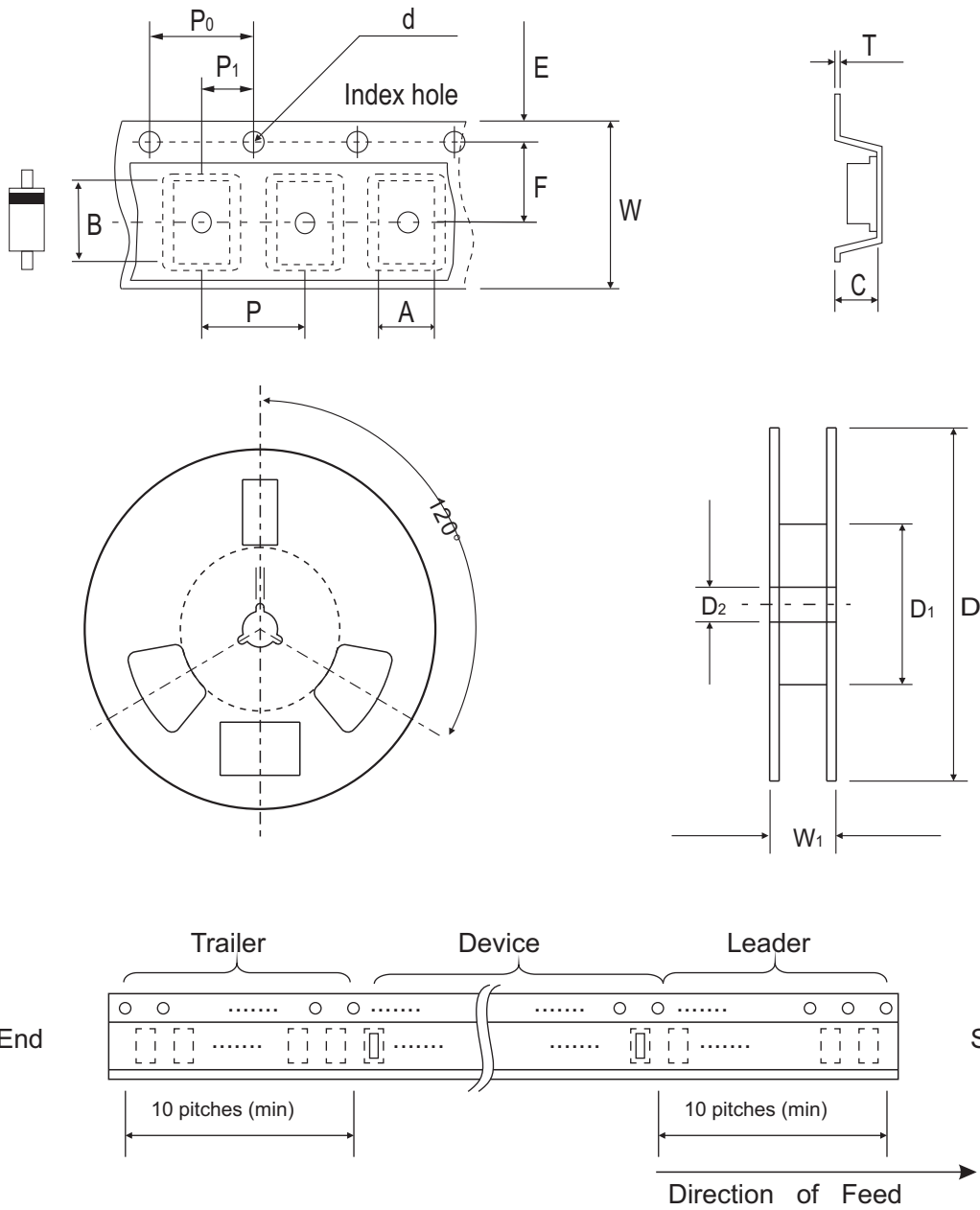

Fig.4- Total Capacitance vs Nominal Zener Voltage



## Reel Taping Specification



SOD-123	SYMBOL	A	B	C	d	D	D1	D2
	(mm)	1.85 ± 0.10	3.94 ± 0.10	1.57 ± 0.10	1.55 ± 0.10	178 ± 1.00	54.40 ± 0.40	13.0 ± 0.20
	(inch)	0.073 ± 0.004	0.155 ± 0.004	0.062 ± 0.004	0.061 ± 0.004	7.008 ± 0.039	2.142 ± 0.016	0.512 ± 0.008

SOD-123	SYMBOL	E	F	P	P0	P1	W	W1
	(mm)	1.75 ± 0.10	3.50 ± 0.05	4.00 ± 0.10	4.00 ± 0.10	2.00 ± 0.10	8.00 + 0.30 / - 0.10	9.50 ± 1.00
	(inch)	0.069 ± 0.004	0.138 ± 0.002	0.158 ± 0.004	0.158 ± 0.004	0.079 ± 0.004	0.315 + 0.011 / - 0.004	0.374 ± 0.039