

D1FT4A

Schottky Barrier Diodes

40V, 3A

Feature

- Small SMD
- High Recovery Speed
- $T_j=175^{\circ}\text{C}$
- Ultra low I_R
- Based on AEC-Q101
- Pb free terminal
- RoHS:Yes

OUTLINE

Package (House Name): 1F
 Package (JEDEC Code): DO-214AC



Equivalent circuit

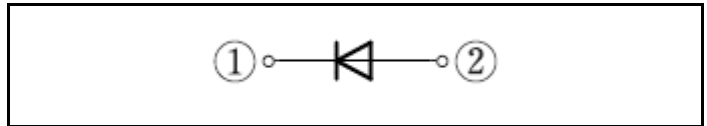

Absolute Maximum Ratings (unless otherwise specified : $T_l=25^{\circ}\text{C}$)

Item	Symbol	Conditions	Ratings	Unit
Storage temperature	T_{stg}		-55 to 175	$^{\circ}\text{C}$
Junction temperature	T_j		-55 to 175	$^{\circ}\text{C}$
Repetitive peak reverse voltage	V_{RRM}		40	V
Average forward current	$I_F(AV)$	50Hz sine wave, Resistance load, $T_l=127^{\circ}\text{C}$	3	A
Average forward current	$I_F(AV)$	50Hz sine wave, Resistance load, On alumina substrate, $T_a=25^{\circ}\text{C}$ ※	2.2	A
Average forward current	$I_F(AV)$	50Hz sine wave, Resistance load, On glass-epoxy substrate, $T_a=25^{\circ}\text{C}$ ※	1.6	A
Surge forward current	I_{FSM}	50Hz sine wave, Non-repetitive, 1 cycle, Peak value, $T_j=25^{\circ}\text{C}$	90	A

※ : See the original Specifications

Electrical Characteristics (unless otherwise specified : Tl=25°C)

Item	Symbol	Conditions	Ratings			Unit
			MIN	TYP	MAX	
Forward voltage	V_F	$I_F=3A$, Pulse measurement			0.74	V
Forward voltage	V_F	$I_F=1A$, Pulse measurement			0.66	V
Reverse current	I_R	$V_R=40V$, Pulse measurement			0.008	mA
Total capacitance	C_t	$f=1MHz$, $V_R=10V$		93		pF
Thermal resistance	$R_{th(j-l)}$	Junction to lead			23	°C/W
Thermal resistance	$R_{th(j-a)}$	Junction to ambient, On alumina substrate ※			108	°C/W
Thermal resistance	$R_{th(j-a)}$	Junction to ambient, On glass-epoxy substrate ※			157	°C/W

※ :See the original Specifications

CHARACTERISTIC DIAGRAMS

Forward Voltage

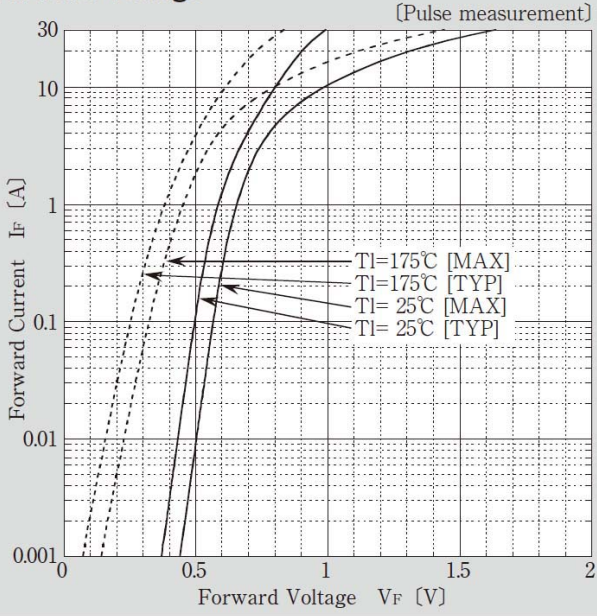

Reverse Current

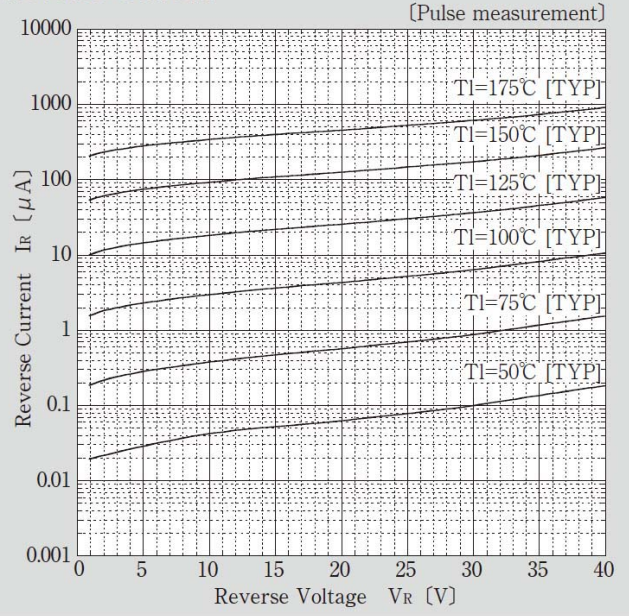

Forward Power Dissipation

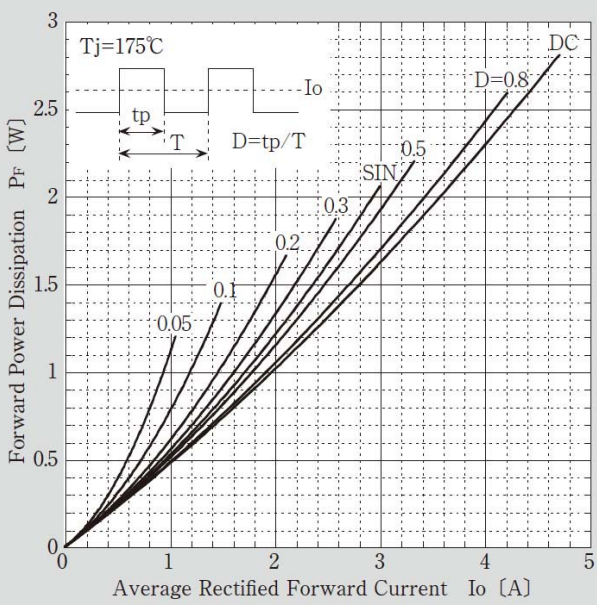

Reverse Power Dissipation

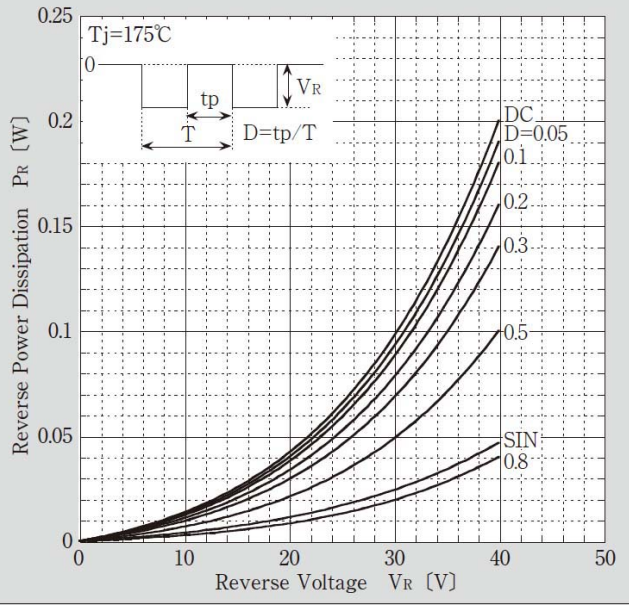

Derating Curve

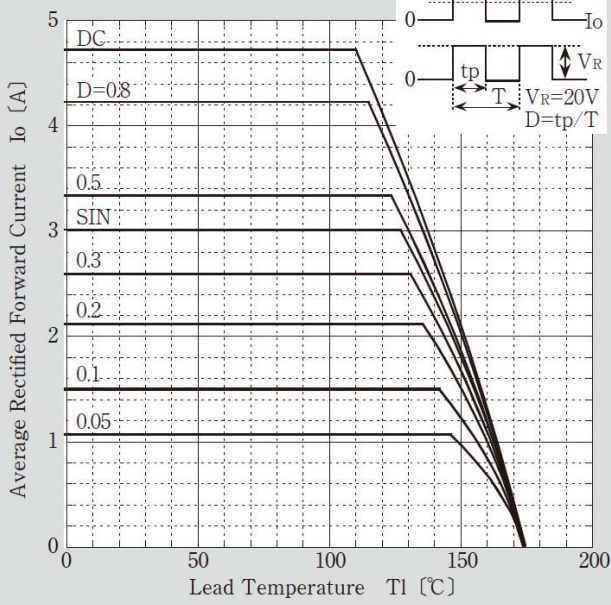

Derating Curve

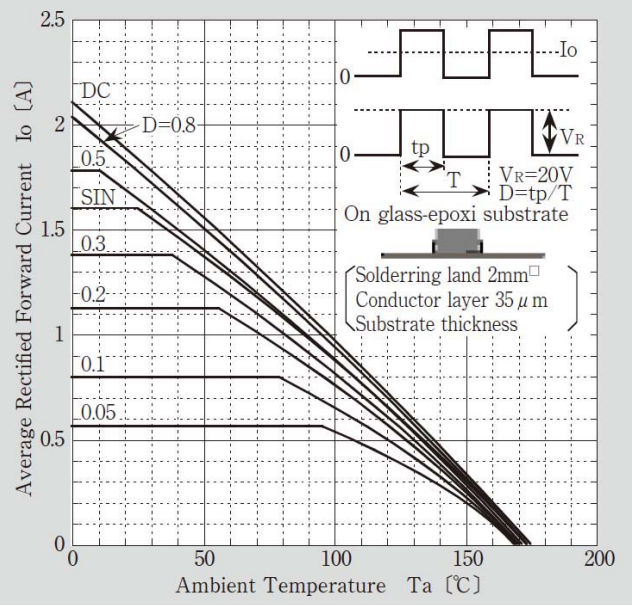

Derating Curve

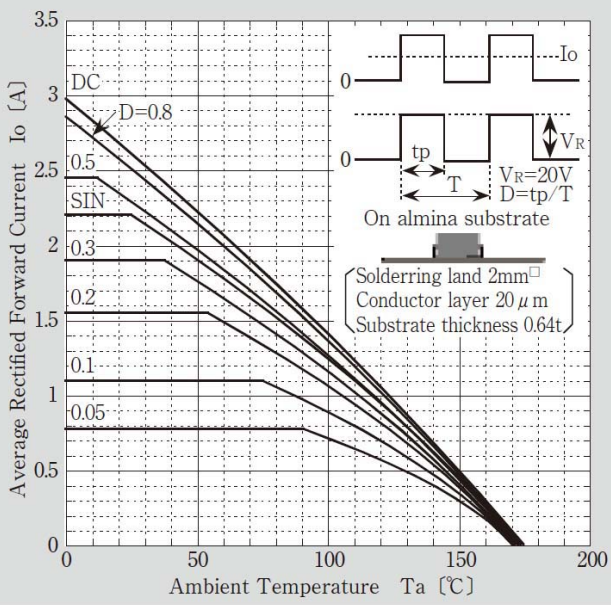

Peak Surge Forward Capability

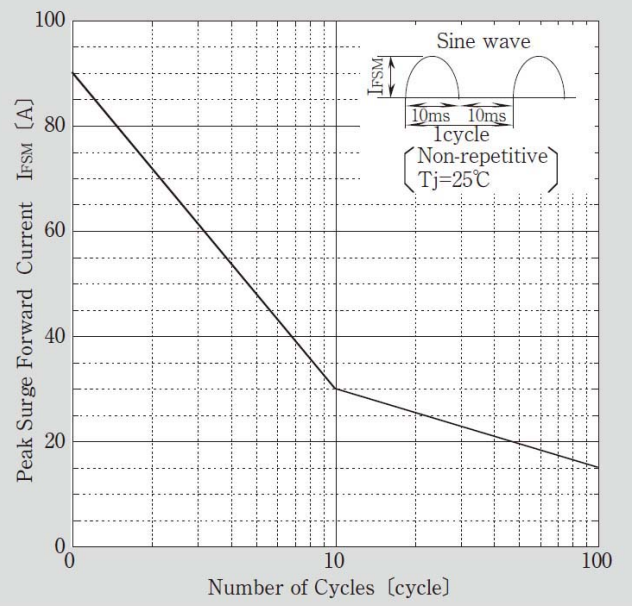

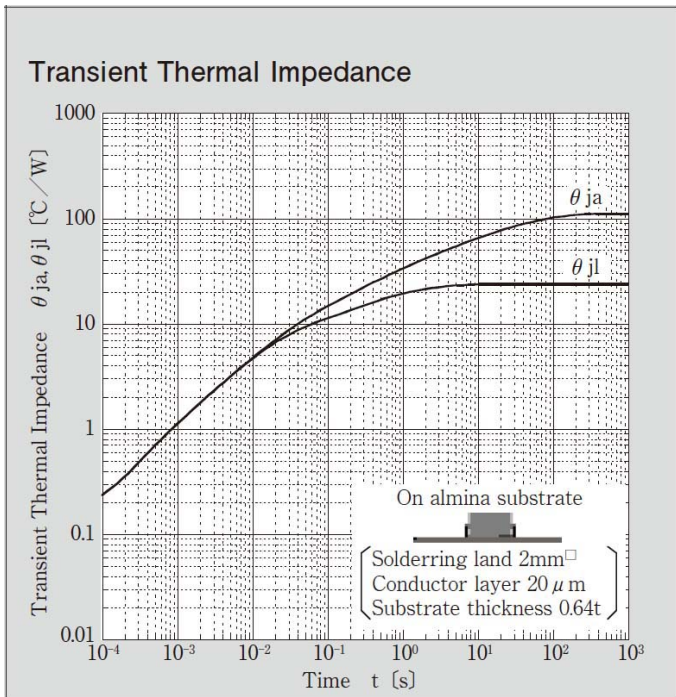
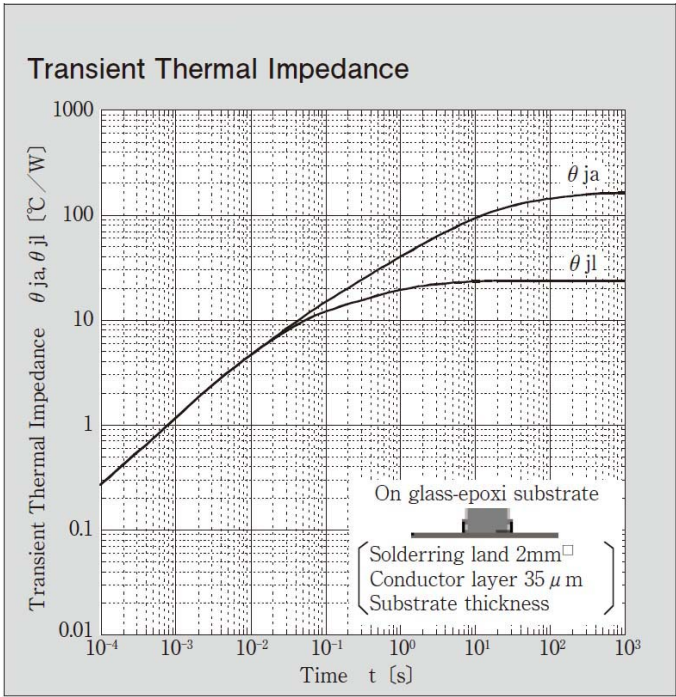
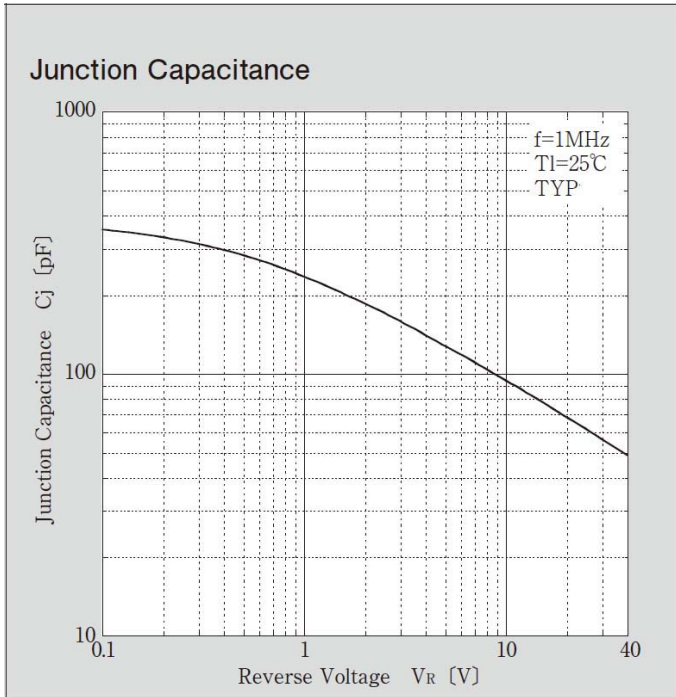

B3

JEDEC Code	DO-214AC
JEITA Code	-
House Name	1F, CF

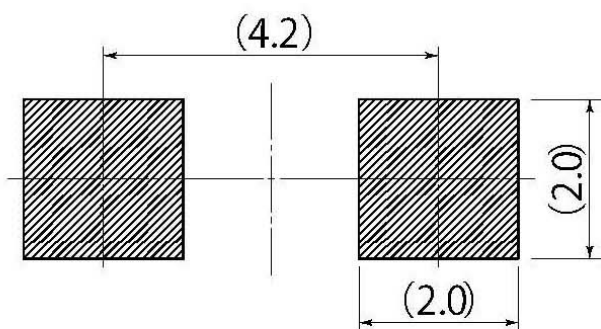
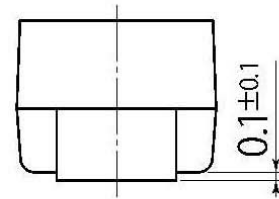
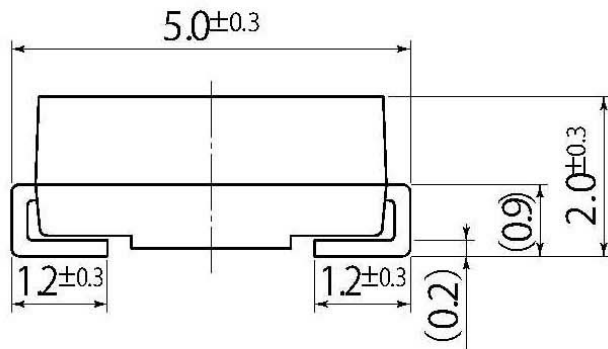
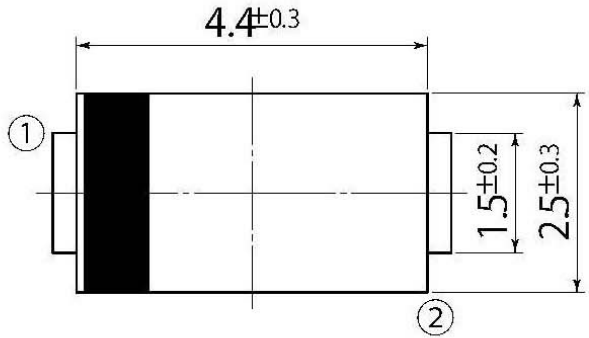

Referential Soldering Pad

• Optimize soldering pad to the board design and soldering condition.