

D5FE60

General Rectifying Diodes
600V, 5.00A

Feature

- Small SMD
- High ESD Capability
- Based on AEC-Q101
- Pb free terminal
- RoHS:Yes

OUTLINE

Package (House Name): 2F



Equivalent circuit

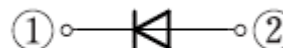

Absolute Maximum Ratings (unless otherwise specified : Tl=25°C)

Item	Symbol	Conditions	Ratings	Unit
Storage temperature	T _{stg}		-55 to 150	°C
Junction temperature	T _j		-55 to 150	°C
Repetitive peak reverse voltage	V _{RRM}		600	V
Average forward current	I _{F(AV)}	50Hz sine wave, Resistance load, Tl=82°C	5	A
Average forward current	I _{F(AV)}	50Hz sine wave, Resistance load, Tl=90°C	4.45	A
Average forward current	I _{F(AV)}	50Hz sine wave, Resistance load, On alumina substrate, Ta=25°C *	2.02	A
Average forward current	I _{F(AV)}	50Hz sine wave, Resistance load, On glass-epoxy substrate, Ta=25°C *	1.44	A
Surge forward current	I _{FSM}	50Hz sine wave, Non-repetitive 1 cycle peak value, Tj=25°C	300	A
Surge forward current	I _{FSM1}	tp=1ms, sine wave, Non-repetitive, peak value, Tj=25°C	720	A

* : See the original Specifications

Electrical Characteristics (unless otherwise specified : Tl=25°C)

Item	Symbol	Conditions	Ratings			Unit
			MIN	TYP	MAX	
Forward voltage	V_F	$I_F=5.0A$, Pulse measurement			0.95	V
Reverse current	I_R	$V_R=600V$, Pulse measurement			10	μA
Electro static discharge Capability	V_{ESD}	$C=330pF$, $R=330\Omega$, Polarity \pm , Aerial discharge		25		kV
Thermal resistance	$R_{th(j-l)}$	Junction to lead			16	$^{\circ}C/W$
Thermal resistance	$R_{th(j-a)}$	Junction to ambient, On alumina substrate ※			80	$^{\circ}C/W$
Thermal resistance	$R_{th(j-a)}$	Junction to ambient, On glass-epoxy substrate ※			115	$^{\circ}C/W$

※ :See the original Specifications

CHARACTERISTIC DIAGRAMS

Forward Voltage

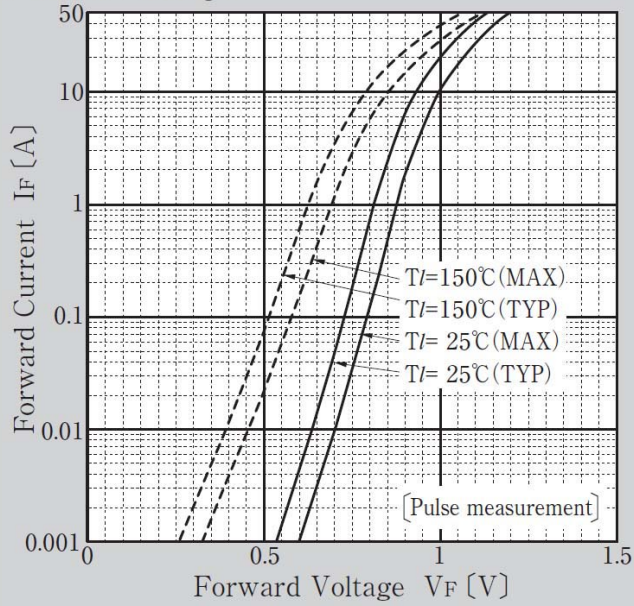

Reverse Current

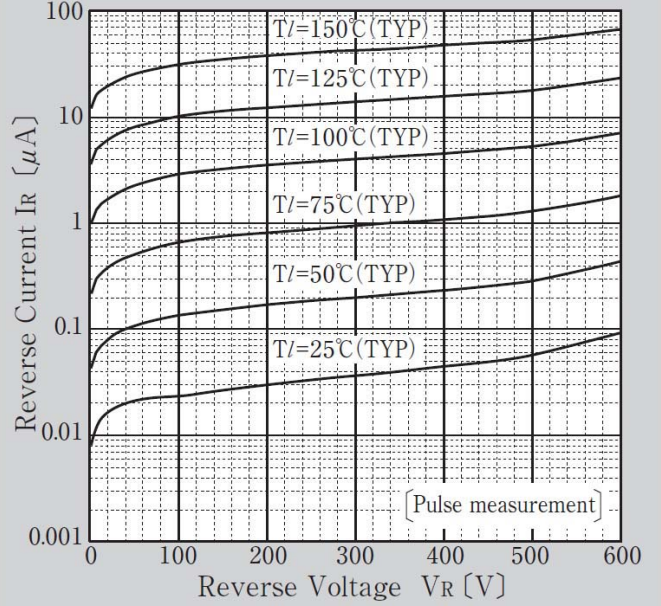

Forward Power Dissipation

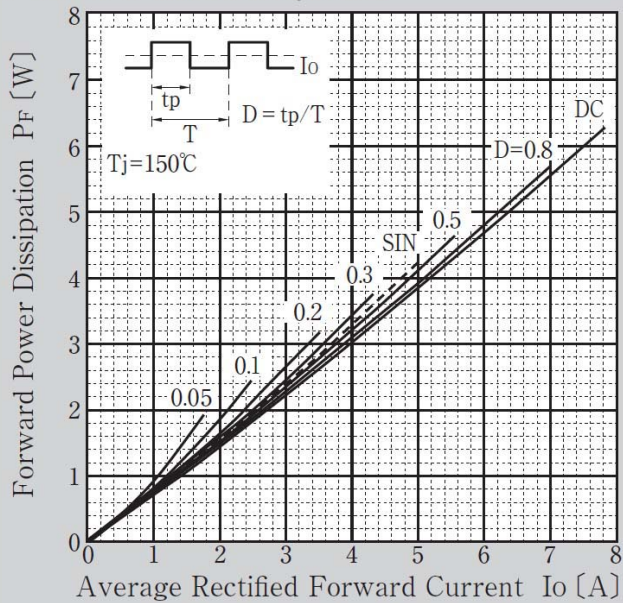

Derating Curve

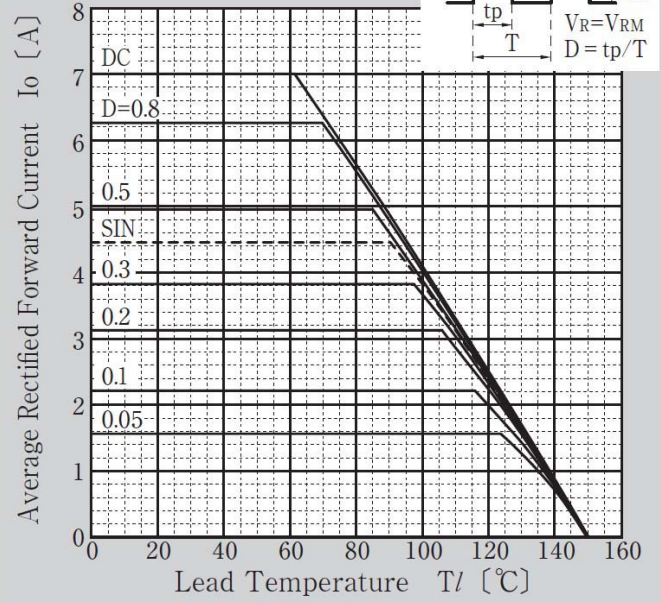

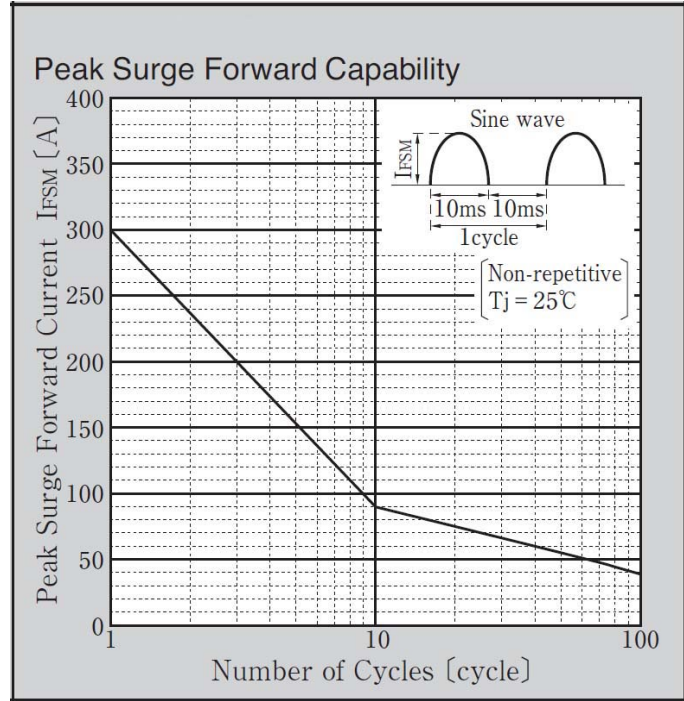
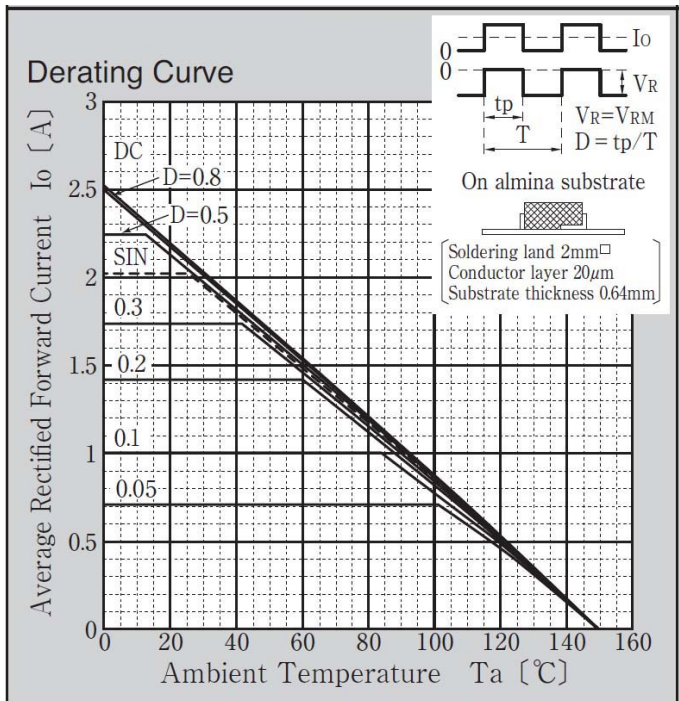
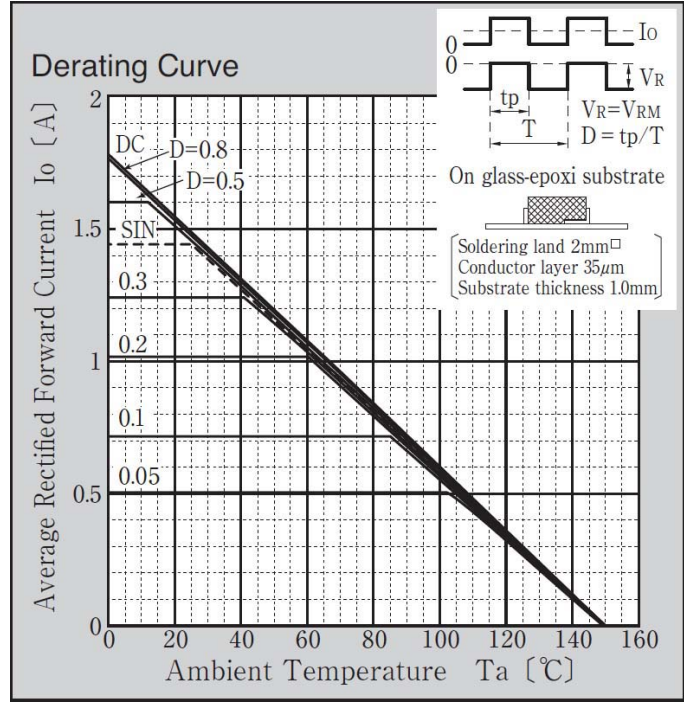
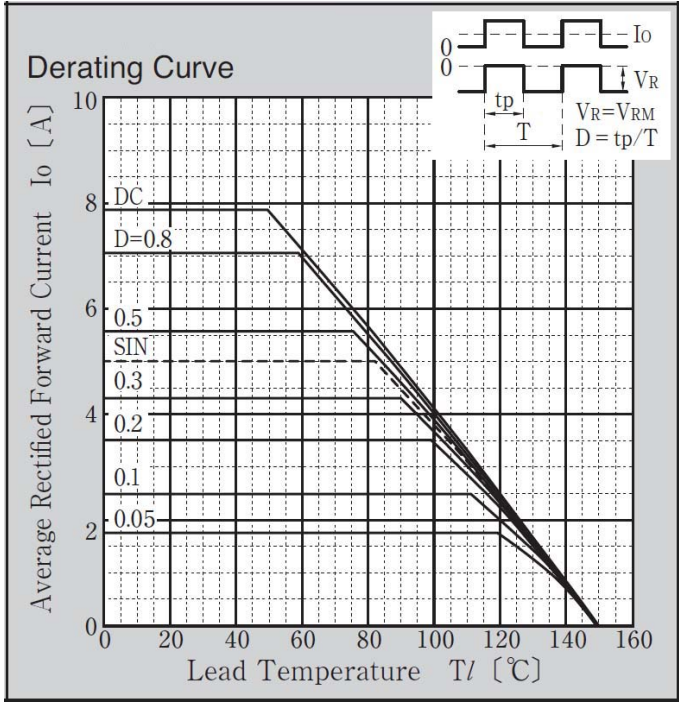

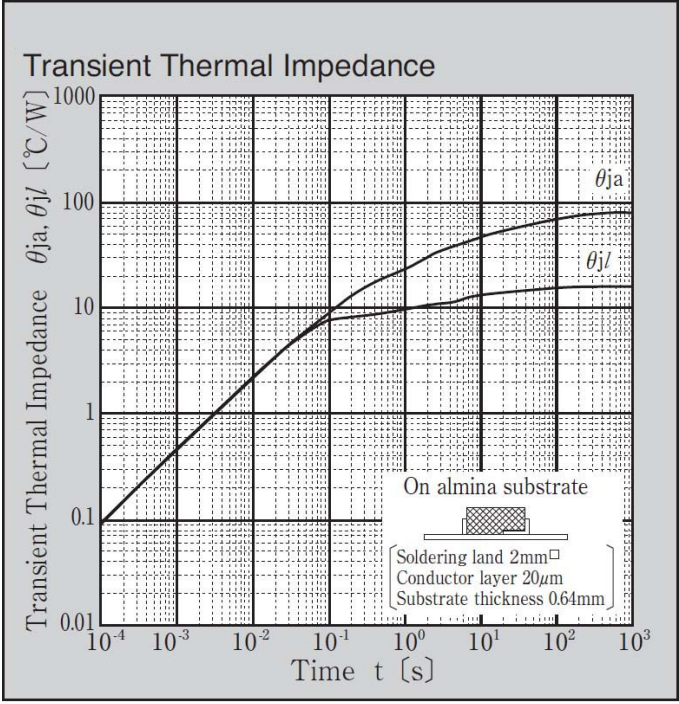
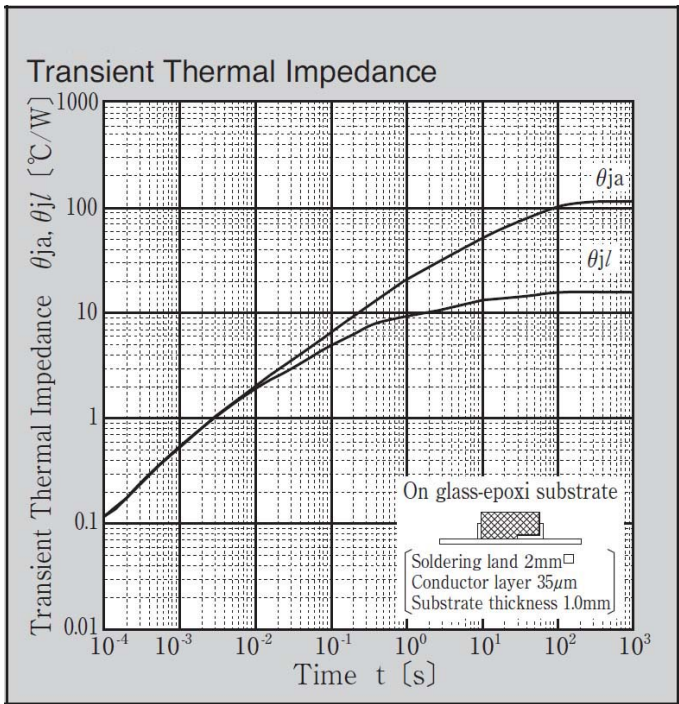
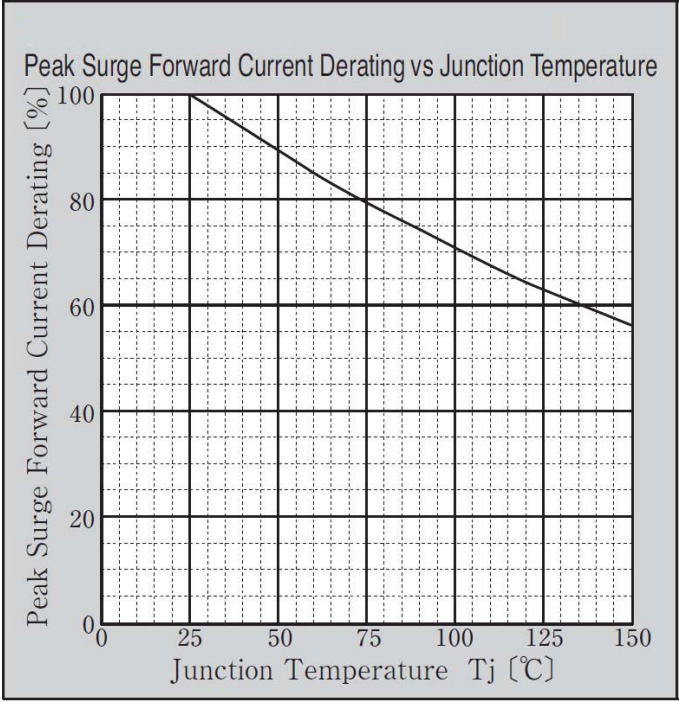
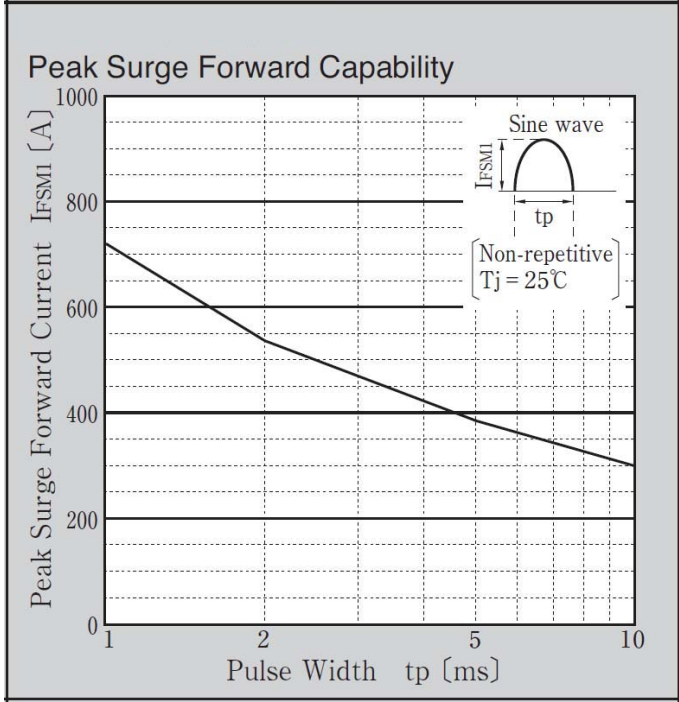

B9

JEDEC Code	—
JEITA Code	—
House Name	2F

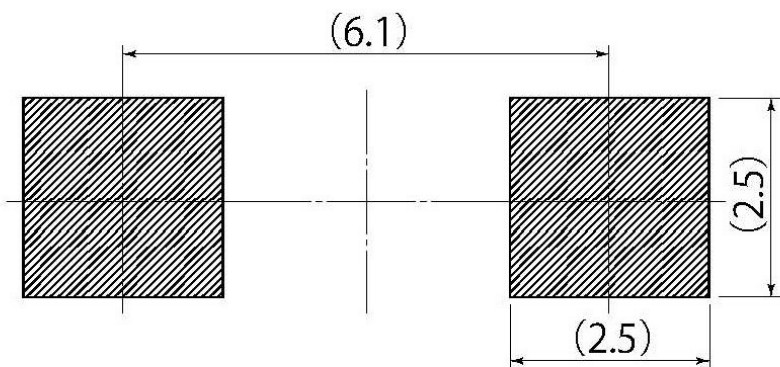
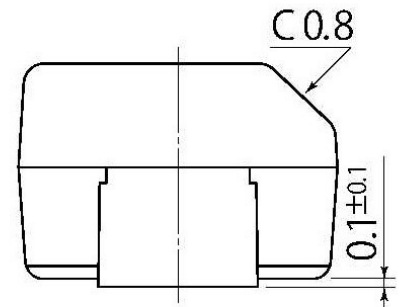
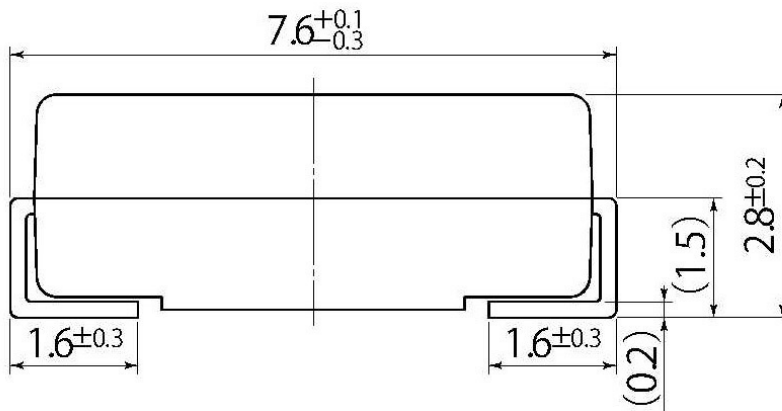
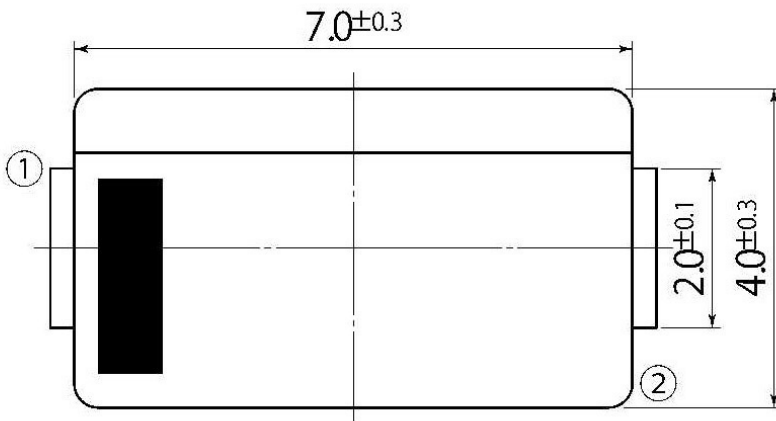

Referential Soldering Pad

• Optimize soldering pad to the board design and soldering condition.