High Efficiency, Ultra-Low Quiescent Current and Ultra-Low Output Ripple Buck Regulator

General Description

DA9232 is a high efficiency, ultra-low quiescent current and ultra-low output ripple buck regulator in a compact I²C configurable WLCSP package targeting battery powered applications needing low ripple and highly efficient power supplies.

The battery life of these devices is significantly improved due to the low quiescent current delivered by DA9232 during operation and shutdown.

The buck regulator extends high light load efficiency down to 10 μ A further extending battery life. Dynamic Voltage Control in the Buck regulator facilitates optimization across the system power modes enabling further improvement in System efficiency and battery life.

DA9232 provides multiple protection features and comes with the ability to monitor the events and indicators in the GPO pin.

Suitable for space constrained applications, the DA9232 comes in a 1.70 mm x 1.30 mm x 0.5 mm, 12-pin WLCSP package.

Key Features

- 60mA buck regulator
 - 750nA total input current (buck enabled, no load)
 - Up to 81% efficiency at 1.8V output, 10 μ A load currents
 - Input voltage 2.5V to 5.5V (Minimum 2.75V for start-up)
 - Output voltage 0.6V to 1.9V
 - Dynamic Voltage Control (DVC)
- I²C interface for device configuration and control
- Protection features and System Monitors
- Small 1.7 mm x 1.3 mm x 0.5 mm, 12-pin WLCSP package

Applications

- Wearables – wrist wear, hearables
- Smart devices - thermostats and door locks
- Smoke detectors
- Portable medical devices
- Remote sensors
- High efficiency, low power applications

High Efficiency, Ultra-Low Quiescent Current and Ultra-Low Output Ripple Buck Regulator

Contents

General Description	1
Key Features	1
Applications	1
Contents	2
Figures	3
Tables	4
1 Terms and Definitions	6
2 Block and Application Diagrams	7
3 Pinout	8
4 Absolute Maximum Ratings	10
5 Recommended Operating Conditions	11
6 ESD Ratings	12
7 Electrical Characteristics	13
8 Thermal Characteristics	16
9 Typical Operating Characteristics	17
9.1 Buck No Load Quiescent Current vs Temperature, Device is Switching	17
9.2 RDSon vs Temperature	17
9.3 Efficiency vs Load Current	18
9.4 Switching Frequency vs Load Current	19
9.5 Buck V _{OUT} Ripple vs Load Current	20
9.6 Buck V _{OUT} vs Load Current	21
9.7 Typical Mode Operation	22
9.8 Buck Load Transient Response	23
9.9 Buck Dynamic Voltage Control	24
9.10 Device Enable and Start up	25
10 Feature Descriptions	26
10.1 Chip Enable and Disable Through IC_EN	26
10.2 VDD Under-Voltage Lockout	26
10.3 Buck Regulator	26
10.3.1 Buck Output Voltage Programmability	26
10.3.2 Start-up Operation	27
10.3.3 Power Saving Mode Operation	27
10.3.4 Dynamic Voltage Control	28
10.3.5 Cycle-by-cycle Over-Current Protection	28
10.3.6 Output Over-Voltage Protection	28

High Efficiency, Ultra-Low Quiescent Current and Ultra-Low Output Ripple Buck Regulator

10.3.7	Output Under-Voltage Protection	28
10.3.8	Automatic Output voltage Discharge	28
10.3.9	Event Flag and Fault Control	29
10.4	I ² C Programming	30
10.4.1	Interface Description	30
10.4.2	Details of the I ² C Protocol	30
10.5	GPO Pin Function Programming	32
10.5.1	Power Good Indicator	32
10.5.2	Event Indicator	32
10.5.3	Reset Pulse Generation	32
10.5.4	Always Pull-Down or Hi-Z	33
11	Register Overview	34
11.1	Register Map	34
11.1.1	Buck Control	34
11.1.2	System Module	35
11.2	Register Definitions	35
11.2.1	Buck Control	35
11.2.1.1	Event/Status/Mask Registers	35
11.2.1.2	User Registers	38
11.2.2	System Module	43
11.2.2.1	System Reset Registers	43
11.2.2.2	System ID Registers	44
12	Package Information	46
12.1	Package Outlines	46
12.2	Moisture Sensitivity Level	47
12.3	Soldering Information	47
13	Ordering Information	48
	Contacting Dialog Semiconductor	49

Figures

Figure 1:	Block Diagram	7
Figure 2:	DA9232 Application Diagram	7
Figure 3:	Pinout Diagram (Top View)	8
Figure 4:	Buck VOUT = 1.8 V	17
Figure 5:	Buck VOUT = 0.7 V	17
Figure 6:	High-Side FET	17
Figure 7:	Low-Side FET	17
Figure 8:	Buck VOUT = 1.8 V	18
Figure 9:	Buck VOUT = 1.2 V	18

High Efficiency, Ultra-Low Quiescent Current and Ultra-Low Output Ripple Buck Regulator

Figure 10: Buck VOUT = 0.9V	18
Figure 11: Buck VOUT = 0.7 V	18
Figure 122: Buck VOUT = 1.8 V	19
Figure 133: Buck VOUT = 1.2 V	19
Figure 144: Buck VOUT = 0.9 V	19
Figure 15: Buck VOUT = 0.7 V	19
Figure 166: Buck VOUT = 1.8 V	20
Figure 17: Buck VOUT = 1.2 V	20
Figure 180: Buck VOUT = 1.8 V	21
Figure 191: Buck VOUT = 1.2 V	21
Figure 204: Buck VIN = 3.6 V, Buck VOUT = 1.8 V, Buck ILOAD = 1 mA	22
Figure 215: Buck VIN = 3.6 V, Buck VOUT = 1.8 V, Buck ILOAD = 60 mA	22
Figure 226: Buck VIN = 3.6 V, Buck VOUT = 0.7 V, Buck ILOAD = 1 mA	22
Figure 237: Buck VIN = 3.6 V, Buck VOUT = 0.7 V, Buck ILOAD = 60 mA	22
Figure 248: Buck ILOAD = 0.5 mA to 60 mA to 0.5 mA (0.1A/μs); Buck VIN = 3.6 V, Buck VOUT = 1.8 V	23
Figure 250: Buck VOUT 0.6 V to 1.2 V; Buck VIN = 3.6 V, Buck ILOAD = 60 mA	24
Figure 261: Buck VOUT 1.2 V to 0.6 V; Buck VIN = 3.6 V, Buck ILOAD = 60 mA	24
Figure 272: Buck VOUT 1.3 V to 1.9 V; Buck VIN = 3.6 V, Buck ILOAD = 60 mA	24

Tables

Table 1: Pin Description	8
Table 2: Pin Type Definition	9
Table 3: Absolute Maximum Ratings	10
Table 4: Recommended Operating Conditions	11
Table 5: Input Current	13
Table 6: Buck Output	13
Table 7: GPO - Electrical performance	14
Table 8: Analog Core - Electrical performance	14
Table 9: I2C interface	15
Table 10: Thermal Characteristics	16
Table 11: Buck Output Voltage Settings	26
Table 12: GPO as Power Good Indicator	32
Table 13: Event/Status/Mask and User Registers	34
Table 14: System Reset Registers	35
Table 15: Register EVENT	35
Table 16: Register STATUS	36
Table 17: Register MASK	37
Table 18: Register GPO	38
Table 19: Register BUCK	39
Table 20: Register BUCK_CFG	41
Table 21: Register FAUL_CTL	42
Table 22: Register PIN_MONITOR	43
Table 23: Register SYS_RST_EVENT	43
Table 24: Register SYS_SRST	44
Table 25: Register SYS_DEVICE_ID	44
Table 26: Register SYS_VARIANT_ID	45
Table 27: Register SYS_CONFIG_ID	45

High Efficiency, Ultra-Low Quiescent Current and Ultra-Low Output Ripple Buck Regulator

Table 28: MSL Classification 47
Table 29: Ordering Information 48
Table 30: OTP List..... 48

High Efficiency, Ultra-Low Quiescent Current and Ultra-Low Output Ripple Buck Regulator

NDA Confidential

1 Terms and Definitions

CDM	Charged Device Model
DC	Direct Current
DCM	Discontinuous Conduction Mode
FET	Field Effect Transistor
NMOS	N-channel Metal-Oxide-Semiconductor
OTP	One-Time Programmable (memory)
PMIC	Power Management IC
PMOS	P-channel Metal-Oxide-Semiconductor
R/W	Read/Write
SCL	Serial Clock SDA
T&R	Tape and Reel
UVLO	Under-Voltage Lock Out
WLCSP	Wafer-Level Chip-Scale Package

High Efficiency, Ultra-Low Quiescent Current and Ultra-Low Output Ripple Buck Regulator NDA Confidential

2 Block and Application Diagrams

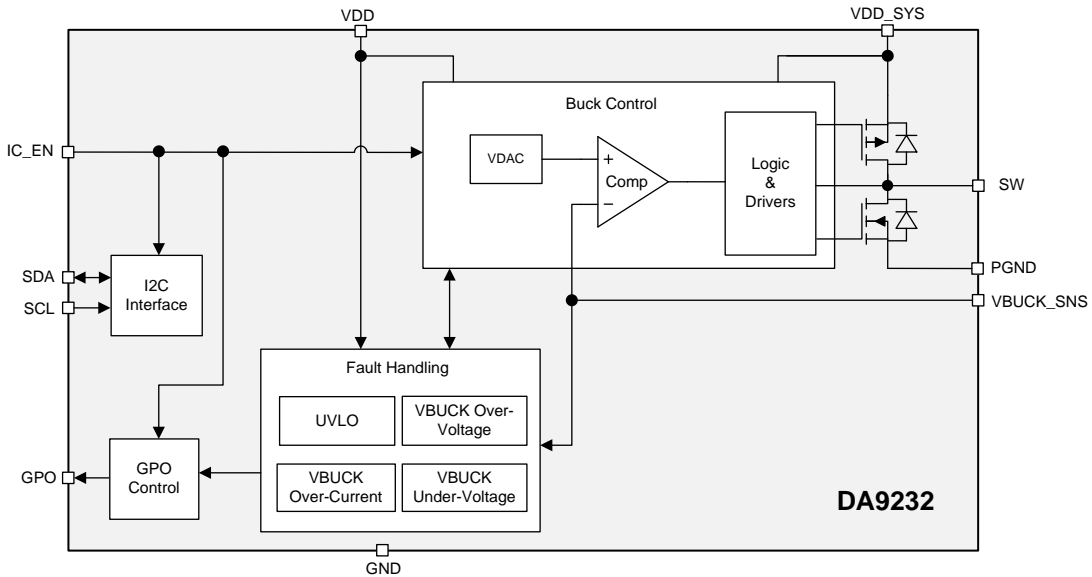

Figure 1: Block Diagram

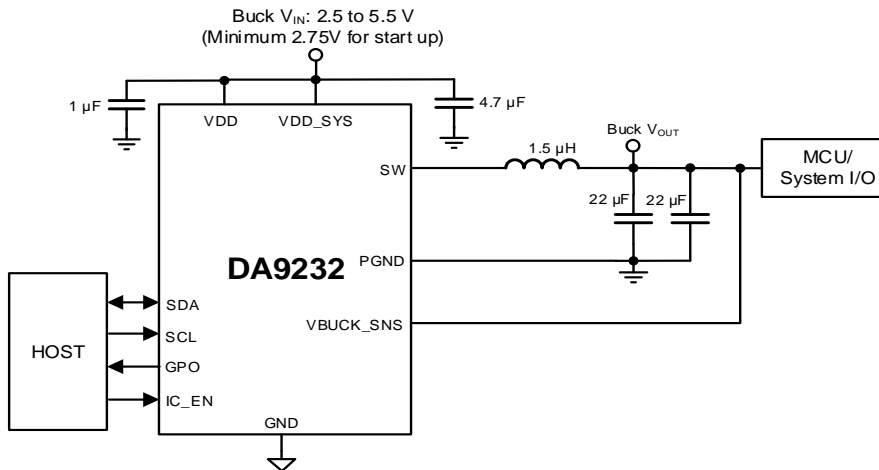

Figure 2: DA9232 Application Diagram

High Efficiency, Ultra-Low Quiescent Current and Ultra-Low Output Ripple Buck Regulator

NDA Confidential

3 Pinout

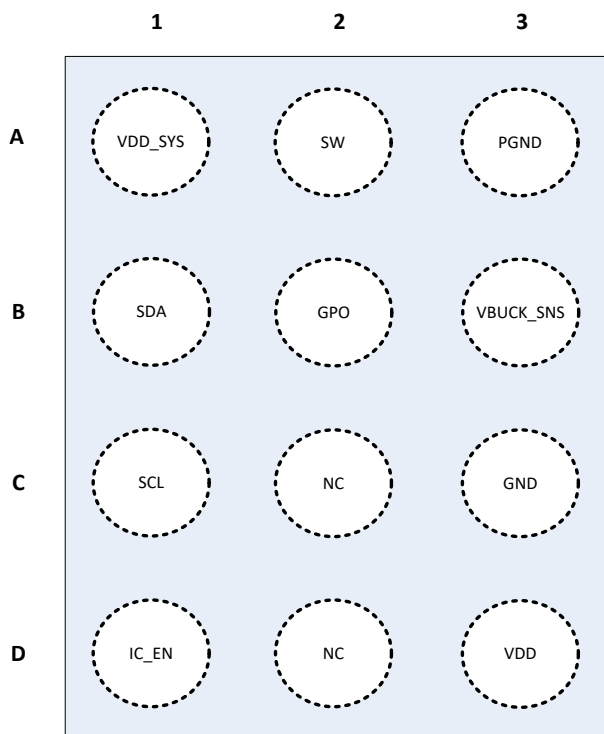

Figure 3: Pinout Diagram (Top View)

Table 1: Pin Description

Pin #	Pin Name	Type (See Table 2)	Drive (mA)	Reset State	Description
A1	VDD_SYS	AI			Buck V_{IN}
A2	SW	AIO			Buck switch node
A3	PGND	AIO			Buck ground
B1	SDA	DIO			I ² C serial data
B2	GPO	DO			General purpose output
B3	VBUCK_SNS	AI			Buck V_{OUT} /feedback voltage
C1	SCL	DI			I ² C serial clock
C2	NC				No connection
C3	GND	AI			Analog ground
D1	IC_EN	DI			Chip enable

High Efficiency, Ultra-Low Quiescent Current and Ultra-Low Output Ripple Buck Regulator

NDA Confidential

Pin #	Pin Name	Type (See Table 2)	Drive (mA)	Reset State	Description
D2	NC				No connection
D3	VDD	AI			Analog V_{IN}

Table 2: Pin Type Definition

Pin Type	Description	Pin Type	Description
DI	Digital Input	AI	Analog Input
DO	Digital Output	AO	Analog Output
DIO	Digital Input / Output	AIO	Analog Input / Output
DIOD	Digital Input / Output open Drain	BP	Back drive Protection
PU	Fixed pull-up resistor	SPU	Switchable pull-up resistor
PD	Fixed pull-down resistor	SPD	Switchable pull-down resistor

High Efficiency, Ultra-Low Quiescent Current and Ultra-Low Output Ripple Buck Regulator

NDA Confidential

4 Absolute Maximum Ratings

Table 3: Absolute Maximum Ratings

Symbol	Description	Conditions	Min	Max	Unit
T _{STG}	Storage temperature		-65	150	°C
T _J	Operating junction temperature		-40	125	°C
VDD	Analog V _{IN} pin	Tied to VDD_SYS	-0.3	6	V
VDD_SYS	Power V _{IN} pin	Tied to VDD	-0.3	6	V
I/O pins	Maximum voltage	I/O pin voltage ≤ VDD	-0.3	6	V

Stresses beyond those listed under Absolute maximum ratings may cause permanent damage to the device. These are stress ratings only, so functional operation of the device at these or any other conditions beyond those indicated in the operational sections of the specification are not implied. Exposure to absolute maximum rating conditions for extended periods may affect device reliability.

High Efficiency, Ultra-Low Quiescent Current and Ultra-Low Output Ripple Buck Regulator

NDA Confidential

5 Recommended Operating Conditions

Table 4: Recommended Operating Conditions

Parameter	Description	Conditions	Min	Typ	Max	Unit
VDD	Analog V_{IN}	Tied to VDD_SYS	2.5 Note 1		5.5	V
VDD_SYS	Power V_{IN}	Tied to VDD	2.5 Note 1		5.5	V
I_{OUT}	Load Current	Output current from SW pin, continuous DC current			60	mA

Note 1 Requires minimum 2.75V for start-up. Once started, input voltage can go down to 2.5V.

High Efficiency, Ultra-Low Quiescent Current and Ultra-Low Output Ripple Buck Regulator

NDA Confidential

6 ESD Ratings

Parameter	Description	Conditions	Value	Unit
V _{ESD}	Electrostatic discharge	Human body model (HBM), per ANSI/ESDA/JEDEC JS-001 Note 2	± 2000	V
		Charged device model (CDM), per JEDEC specification JESD22-C101 Note 3	± 500	

Note 2 JEDEC document JEP155 states that 500-V HBM allows safe manufacturing with a standard ESD control process.

Note 3 JEDEC document JEP157 states that 250-V CDM allows safe manufacturing with a standard ESD control process.

High Efficiency, Ultra-Low Quiescent Current and Ultra-Low Output Ripple Buck Regulator

NDA Confidential

7 Electrical Characteristics

VDD = VDD_SYS = 3.6 V, T_A = -40°C to 85°C. Typical values are at T_A = 25°C (unless otherwise noted).

Table 5: Input Current

Symbol	Parameter	Conditions	Min	Typ	Max	Unit
Electrical performance						
I _{Q_BUCK_ON_NO_LD}	Buck no load quiescent current	-40 °C < T _A < 85 °C Buck enabled and regulating, no load 2.5 V ≤ V _{VDD_SYS} ≤ 5.5 V V _{BUCK} = 1.8 V		0.75	3.5	μA

Table 6: Buck Output

Symbol	Parameter	Conditions	Min	Typ	Max	Unit
Electrical performance						
R _{ON_PMOS}	On resistance of PMOS pass device	V _{VDD_SYS} = 3.6 V I _{OUT} = 50 mA		600	800	mΩ
R _{ON_NMOS}	On resistance of NMOS pass device	V _{VDD_SYS} = 3.6 V I _{OUT} = 50 mA		300	450	mΩ
R _{SYS_DHCG}	MOSFET on-resistance for buck discharge	V _{VDD_SYS} = 3.6 V I _{OUT} = -10 mA into VOUT pin		33		Ω
t _{START}	Buck start-up time	V _{VDD_SYS} = 3.6 V V _{BUCK} = 1.8 V I _{OUT} = 0 A from BUCK_EN = 1 to switching start		3		ms
I _{LIM_SW_PMOS}	SW current limit PMOS	V _{VDD_SYS} = 3.6 V V _{BUCK} = 1.8 V		550		mA
f _{SW}	Switching frequency in continuous conduction mode				1.5	MHz
I _{LIM_PMOS_SOFT_START}	PMOS switch current limit during soft-start	Current limit is reduced during soft-start		250		mA
V _{OUT_VBUCK_SNS}	Buck output voltage range	Programmable range, 50 mV steps	0.6		1.9	V

High Efficiency, Ultra-Low Quiescent Current and Ultra-Low Output Ripple Buck Regulator

NDA Confidential

Symbol	Parameter	Conditions	Min	Typ	Max	Unit
V _{OUT_VBUCK_SN} S_HI	Buck output voltage range	HI programmable range, 50 mV steps V _{OUT_RANGE_HI} = 1	1.3		1.9	V
V _{OUT_VBUCK_SN} S_LO	Buck output voltage range	LO programmable range, 50 mV steps V _{OUT_RANGE_HI} = 0	0.6		1.3	V
V _{OUT_VBUCK_AC} C_HI	Buck output voltage accuracy (Note 1)	V _{VDD_SYS} = 2.5 - 5.5V I _{OUT} = 0 - 60 mA V _{OUT_RANGE_HI} = 1 V _{BUCK} = 1.8 V	-1.5		1.5	%
V _{OUT_VBUCK_AC} C_LO	Buck output voltage accuracy (Note 1)	V _{VDD_SYS} = 2.5 - 5.5 V I _{OUT} = 0 - 60 mA V _{OUT_RANGE_HI} = 0 V _{BUCK} = 0.7 V	-2.5		2.5	%

Note 1: Includes all variations caused by Line and Load Regulations, Ripple and Temperature.

Table 7: GPO - Electrical performance

Symbol	Parameter	Conditions	Min	Typ	Max	Unit
R _{PD}	GPO pull-down resistance	V _{VDD_SYS} = 3.6 V		12		Ω
V _{OH}	GPO Output high voltage	V _{PULLUP} = 1.8 V	1.4			V
V _{OL}	GPO Output low voltage	V _{PULLUP} = 1.8 V			0.4	V

Table 8: Analog Core - Electrical performance

Symbol	Parameter	Conditions	Min	Typ	Max	Unit
V _{TH_UVLO}	Under-voltage lockout threshold	Input voltage falling	2.4		2.5	V
V _{TH_UVLO_RISE}	Under-voltage lockout threshold rising.	Input voltage rising.			2.75	V
V _{HYS_UVLO}	Under-voltage lockout hysteresis	Input voltage rising		200		mV

High Efficiency, Ultra-Low Quiescent Current and Ultra-Low Output Ripple Buck Regulator

NDA Confidential

Table 9: I2C interface

Symbol	Parameter	Conditions	Min	Typ	Max	Unit
Electrical performance						
f _{I2C_CLK}	I ² C bus specification standard and fast mode frequency support		100		400	kHz
V _{IN_HI_THR}	Input high threshold level for SDA and SCL		1.4			V
V _{IN_LO_THR}	Input low threshold level for SDA and SCL				0.4	V
V _{OUT_LO_THR}	Output low threshold level for SDA				0.4	V
I _{LKG_HILVL}	High-level leakage current for SDA and SCL.	V _{PU} = V _{VDD} SDA and SCL			1	μA

High Efficiency, Ultra-Low Quiescent Current and Ultra-Low Output Ripple Buck Regulator NDA Confidential

8 Thermal Characteristics

Table 10: Thermal Characteristics

Parameter	Description	Conditions	Typ	Unit
R_{TH_JA}	Junction-to-ambient thermal resistance	JEDEC 6-layer pcb, no airflow	73.2	°C/W
Ψ_{JT}	Junction-to-top characterization parameter	JEDEC 6-layer pcb, no airflow	6.66	°C/W
R_{TH_JB}	Junction-to-board thermal resistance	JEDEC 6-layer pcb, no airflow	34.8	°C/W

High Efficiency, Ultra-Low Quiescent Current and Ultra-Low Output Ripple Buck Regulator NDA Confidential

9 Typical Operating Characteristics

Test Circuit of Figure 2, Buck $V_{IN} = VDD_SYS = VDD$, $T_A = 25^\circ C$, unless specified otherwise.

9.1 Buck No Load Quiescent Current vs Temperature, Device is Switching

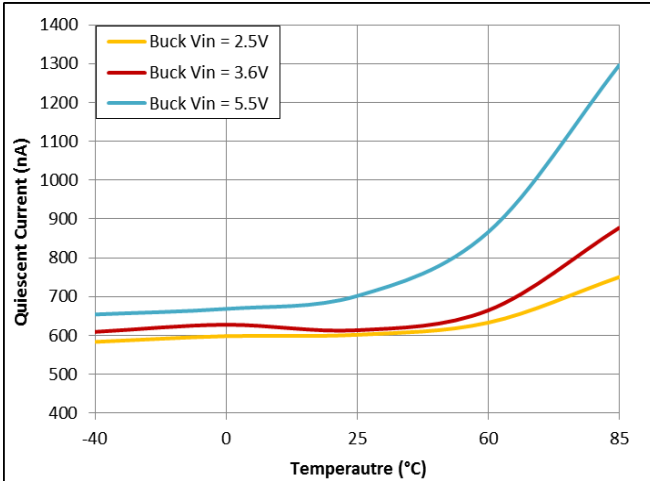

Figure 4: Buck $V_{OUT} = 1.8 V$

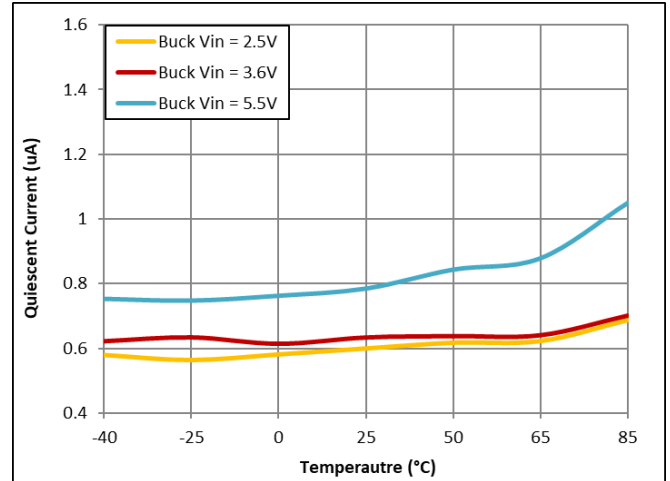

Figure 5: Buck $V_{OUT} = 0.7 V$

9.2 R_{DSon} vs Temperature

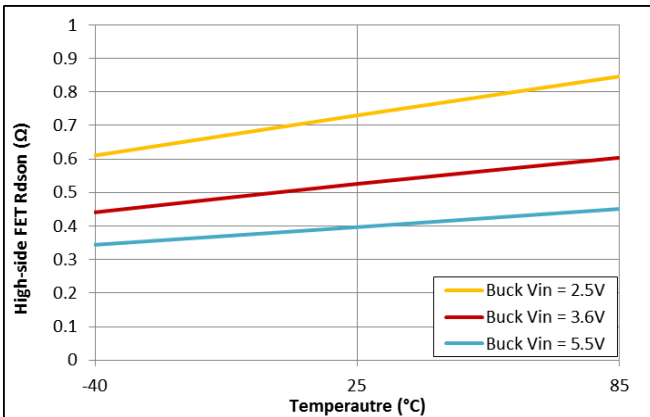

Figure 6: High-Side FET

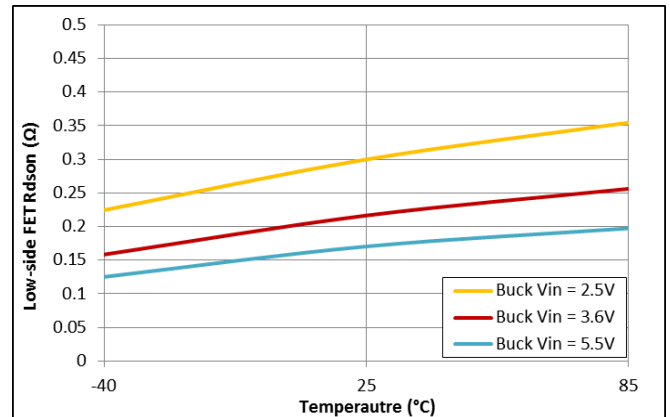

Figure 7: Low-Side FET

High Efficiency, Ultra-Low Quiescent Current and Ultra-Low Output Ripple Buck Regulator

NDA Confidential

9.3 Efficiency vs Load Current

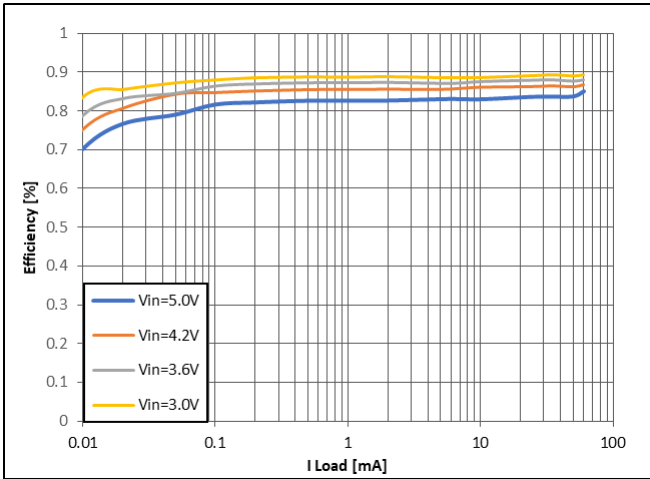

Figure 8: Buck V_{OUT} = 1.8 V

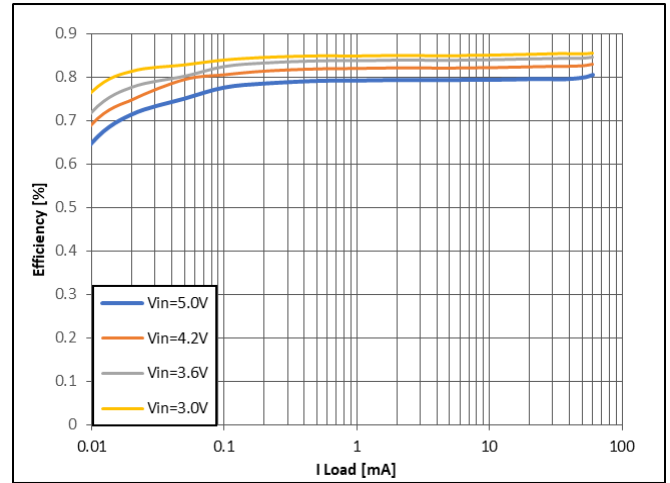

Figure 9: Buck V_{OUT} = 1.2 V

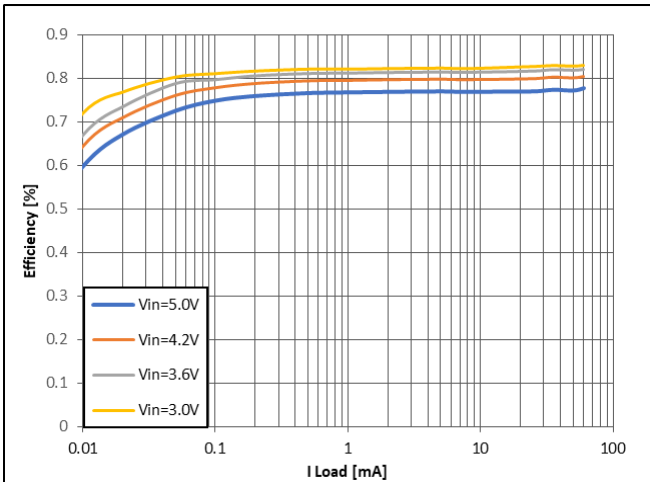

Figure 10: Buck V_{OUT} = 0.9V

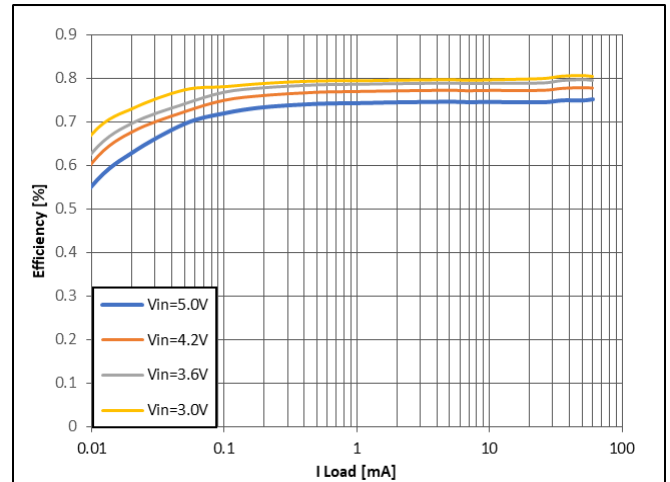

Figure 11: Buck V_{OUT} = 0.7 V

High Efficiency, Ultra-Low Quiescent Current and Ultra-Low Output Ripple Buck Regulator

NDA Confidential

9.4 Switching Frequency vs Load Current

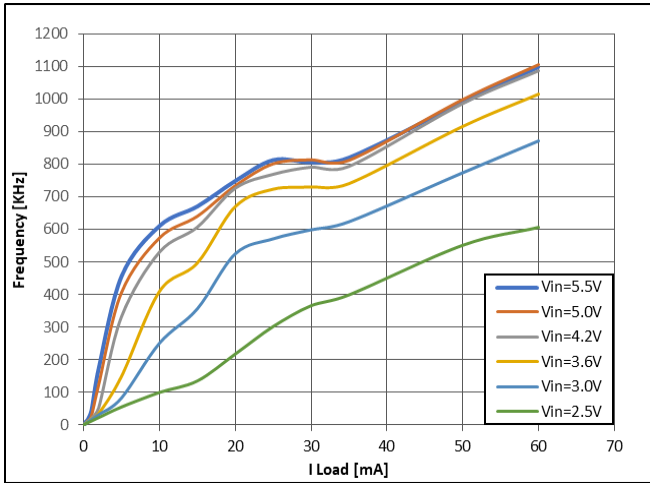

Figure 122: Buck V_{OUT} = 1.8 V

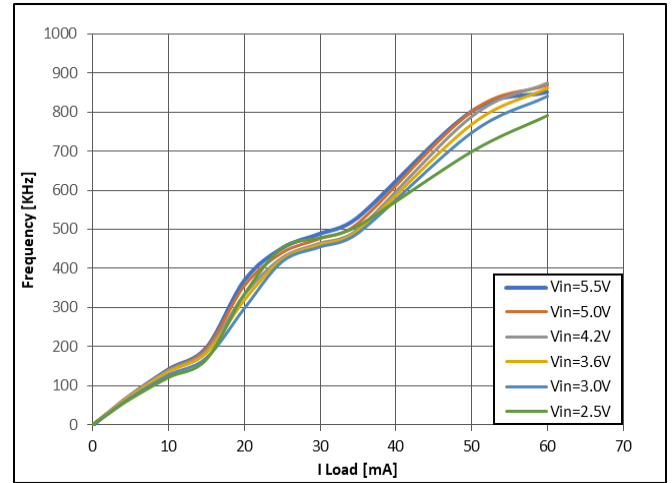

Figure 133: Buck V_{OUT} = 1.2 V

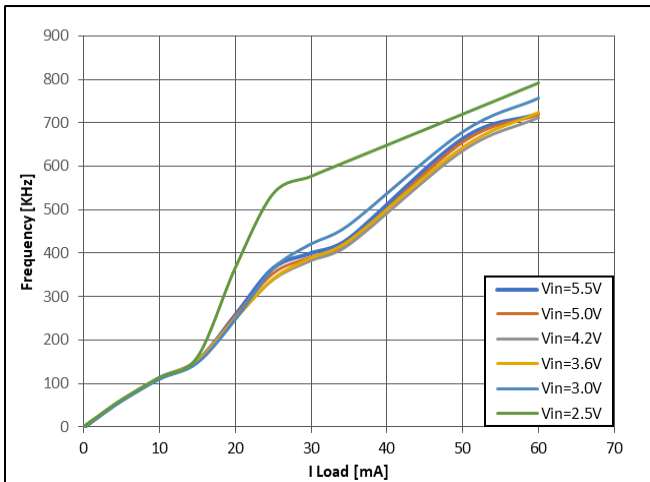

Figure 144: Buck V_{OUT} = 0.9 V

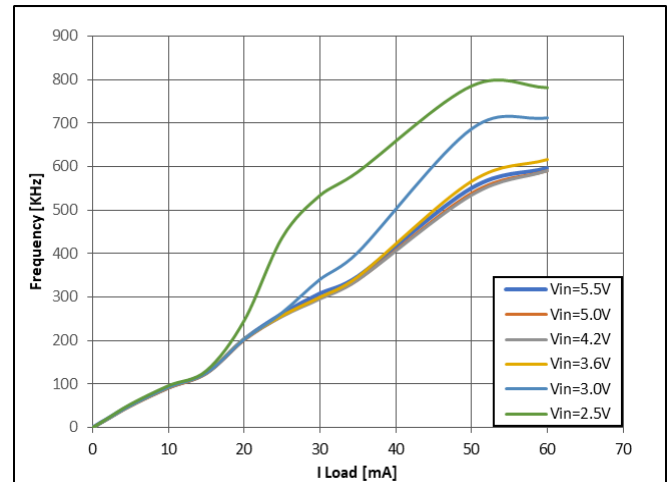

Figure 15: Buck V_{OUT} = 0.7 V

High Efficiency, Ultra-Low Quiescent Current and Ultra-Low Output Ripple Buck Regulator

NDA Confidential

9.5 Buck V_{OUT} Ripple vs Load Current

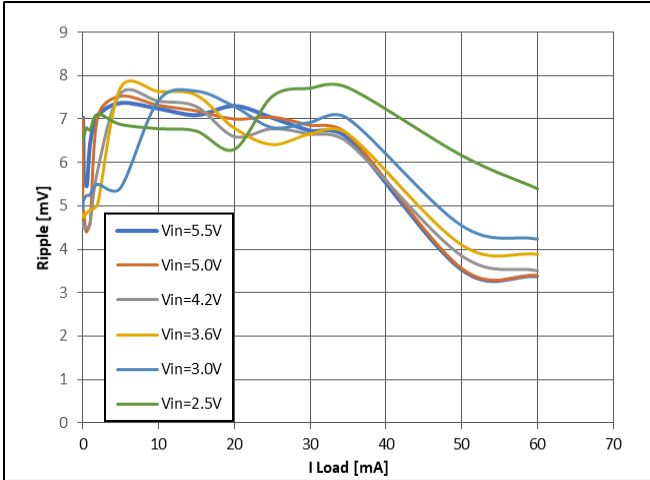

Figure 166: Buck $V_{OUT} = 1.8\text{ V}$

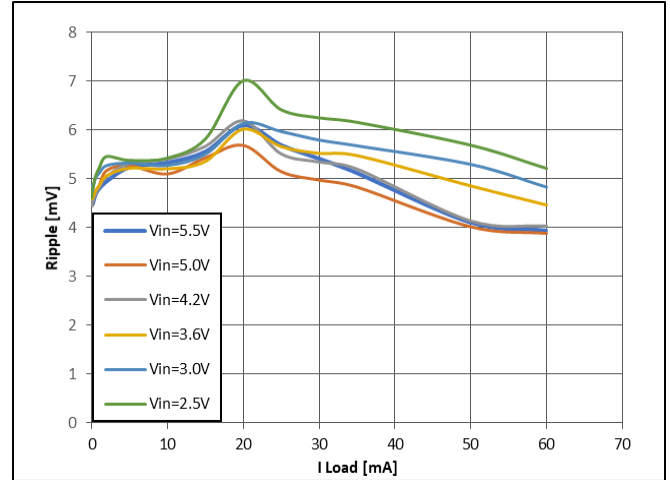

Figure 17: Buck $V_{OUT} = 1.2\text{ V}$

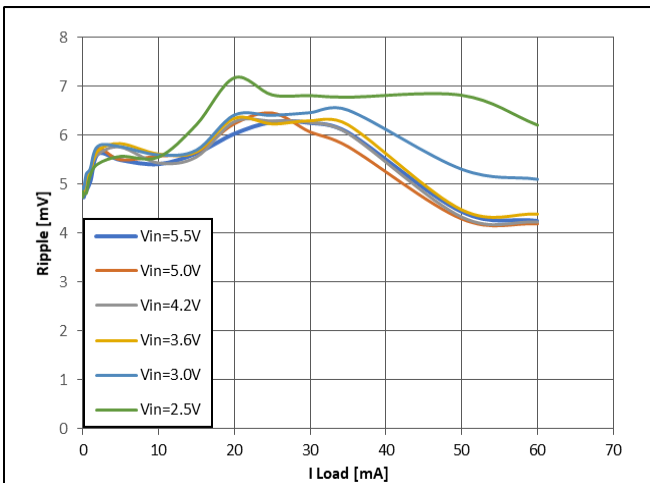

Figure 18: Buck $V_{OUT} = 0.9\text{ V}$

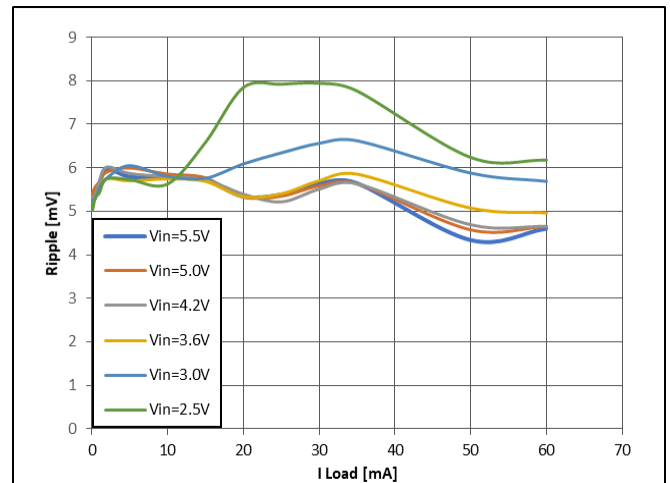

Figure19: Buck $V_{OUT} = 0.7\text{ V}$

High Efficiency, Ultra-Low Quiescent Current and Ultra-Low Output Ripple Buck Regulator NDA Confidential

9.6 Buck V_{OUT} vs Load Current

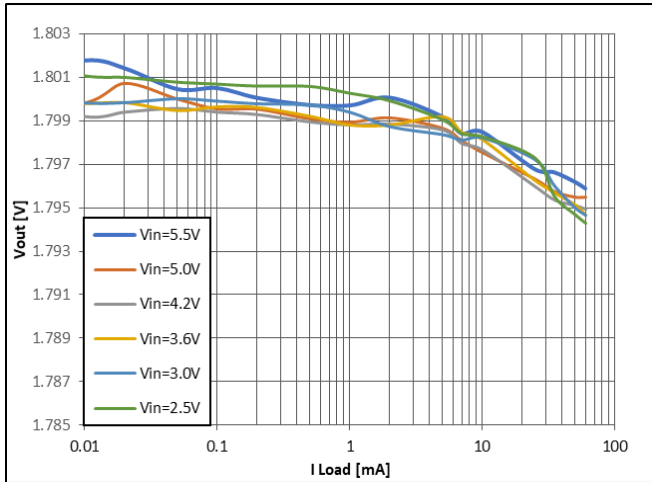

Figure 180: Buck V_{OUT} = 1.8 V

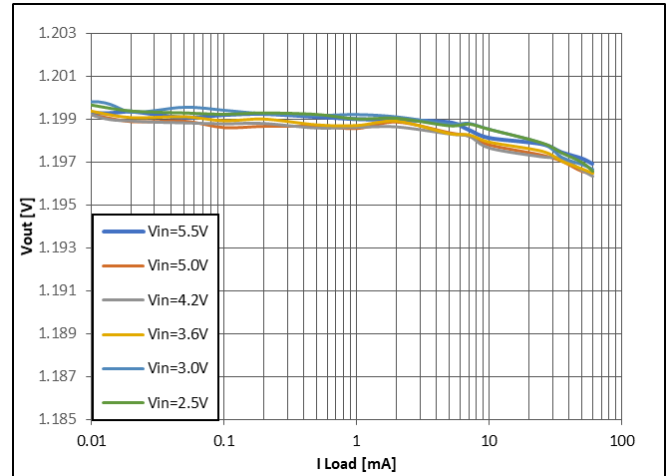

Figure 191: Buck V_{OUT} = 1.2 V

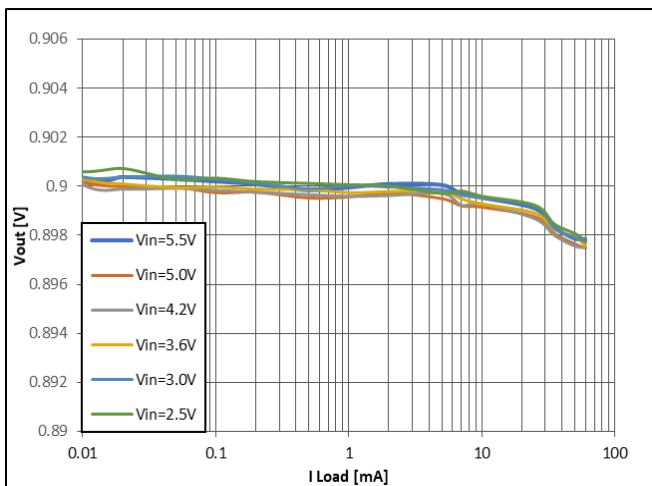

Figure 22: Buck V_{OUT} = 0.9 V

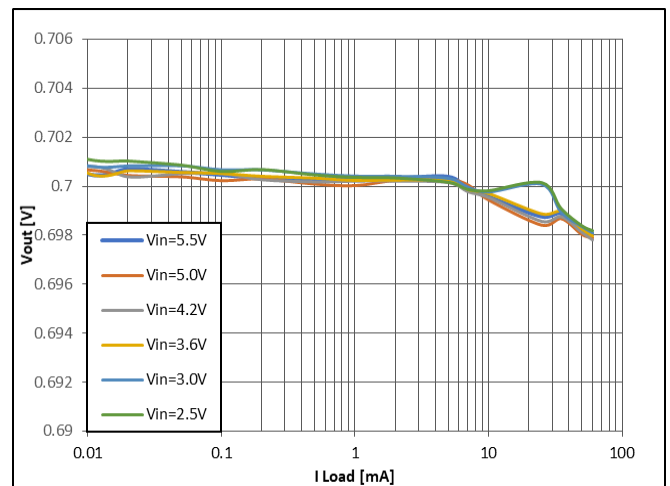

Figure 23: Buck V_{OUT} = 0.7 V

High Efficiency, Ultra-Low Quiescent Current and Ultra-Low Output Ripple Buck Regulator NDA Confidential

9.7 Typical Mode Operation

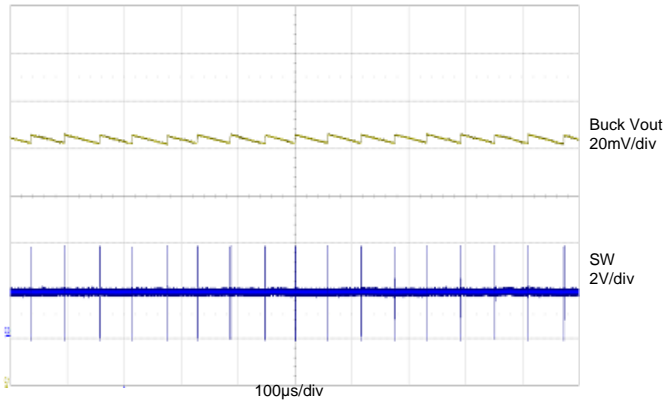

Figure 204: Buck $V_{IN} = 3.6$ V, Buck $V_{OUT} = 1.8$ V, Buck $I_{LOAD} = 1$ mA

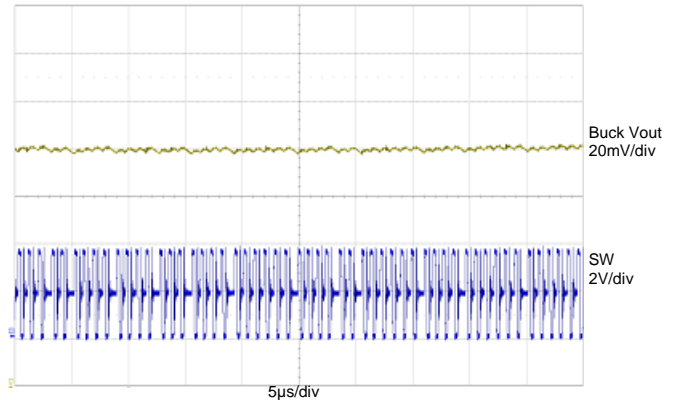

Figure 215: Buck $V_{IN} = 3.6$ V, Buck $V_{OUT} = 1.8$ V, Buck $I_{LOAD} = 60$ mA

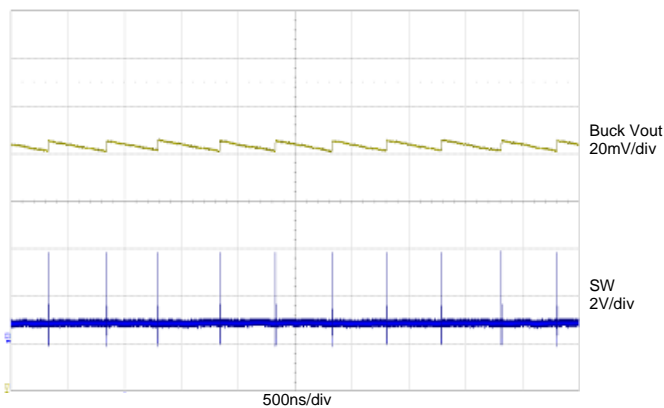

Figure 226: Buck $V_{IN} = 3.6$ V, Buck $V_{OUT} = 0.7$ V, Buck $I_{LOAD} = 1$ mA

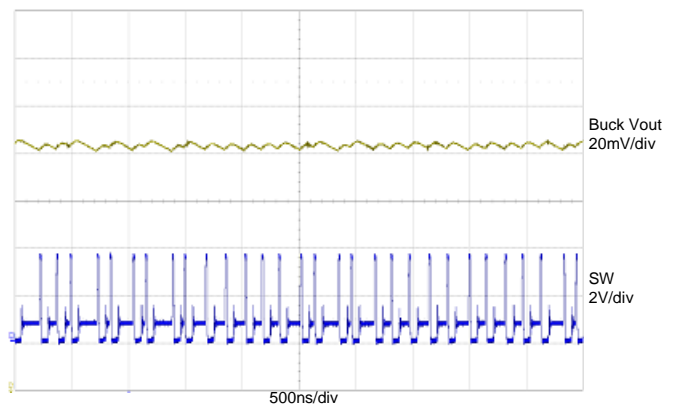

Figure 237: Buck $V_{IN} = 3.6$ V, Buck $V_{OUT} = 0.7$ V, Buck $I_{LOAD} = 60$ mA

High Efficiency, Ultra-Low Quiescent Current and Ultra-Low Output Ripple Buck Regulator

NDA Confidential

9.8 Buck Load Transient Response

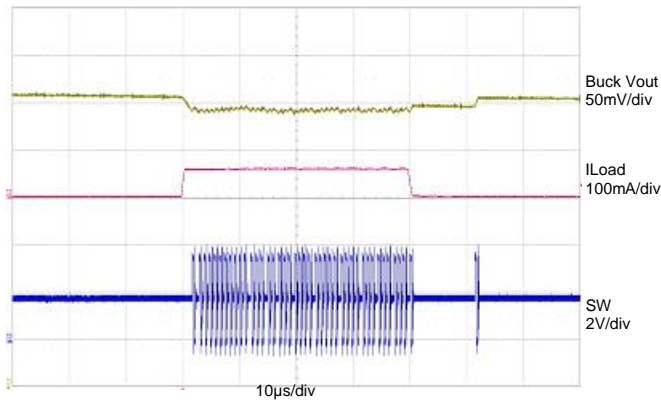

Figure 248: Buck $I_{LOAD} = 0.5 \text{ mA}$ to 60 mA to 0.5 mA ($0.1 \text{ A}/\mu\text{s}$); Buck $V_{IN} = 3.6 \text{ V}$, Buck $V_{OUT} = 1.8 \text{ V}$

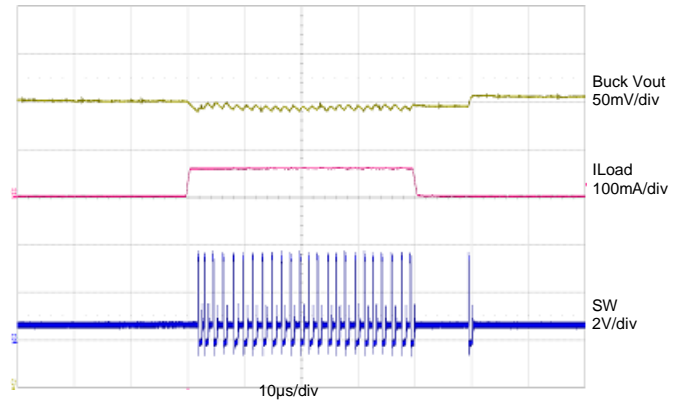
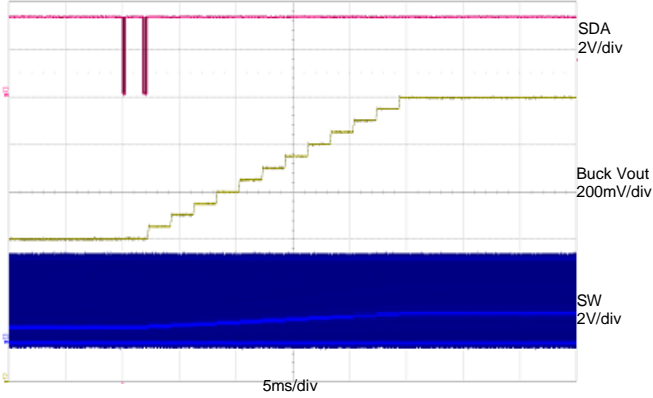

Figure 29: Buck $I_{LOAD} = 0.5 \text{ mA}$ to 60 mA to 0.5 mA ($0.1 \text{ A}/\mu\text{s}$); Buck $V_{IN} = 3.6 \text{ V}$, Buck $V_{OUT} = 0.7 \text{ V}$

High Efficiency, Ultra-Low Quiescent Current and Ultra-Low Output Ripple Buck Regulator NDA Confidential

9.9 Buck Dynamic Voltage Control



**Figure 250: Buck V_{OUT} 0.6 V to 1.2 V;
Buck V_{IN} = 3.6 V, Buck I_{LOAD} = 60 mA**

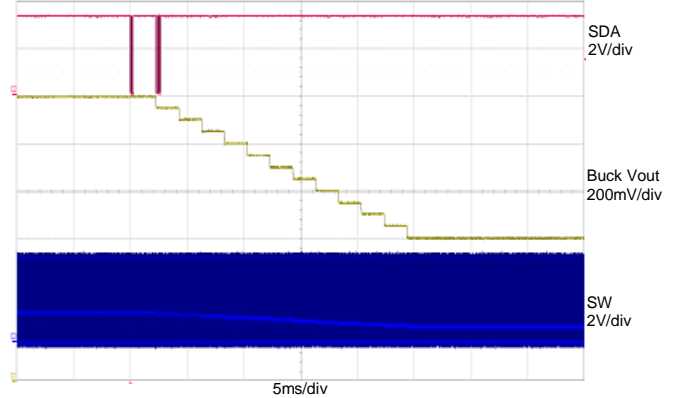

**Figure 261: Buck V_{OUT} 1.2 V to 0.6 V;
Buck V_{IN} = 3.6 V, Buck I_{LOAD} = 60 mA**

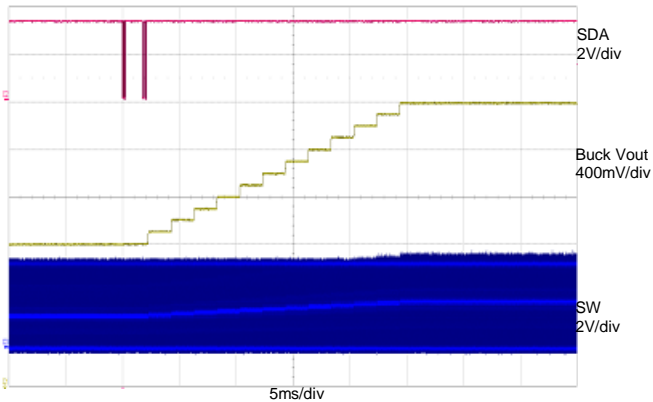

**Figure 272: Buck V_{OUT} 1.3 V to 1.9 V;
Buck V_{IN} = 3.6 V, Buck I_{LOAD} = 60 mA**

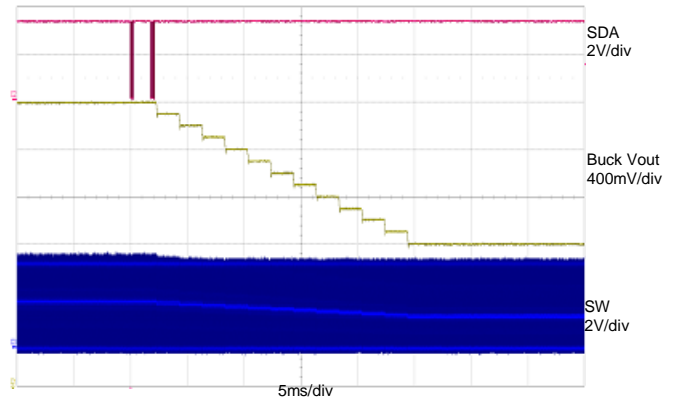

**Figure 33: Buck V_{OUT} 1.9 V to 1.3 V;
Buck V_{IN} = 3.6 V, Buck I_{LOAD} = 60 mA**

High Efficiency, Ultra-Low Quiescent Current and Ultra-Low Output Ripple Buck Regulator NDA Confidential

9.10 Device Enable and Start up

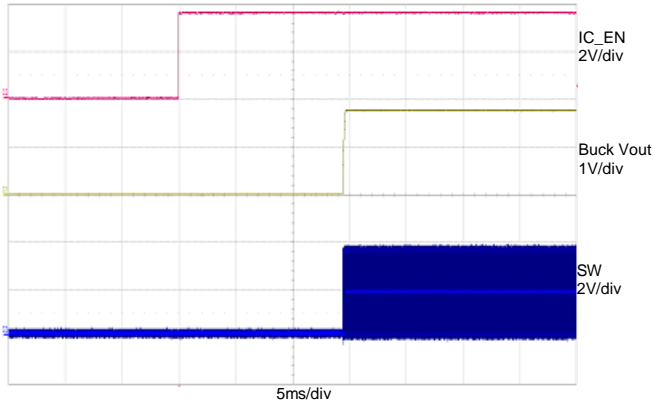

Figure 34: Device Enable:
 Buck $V_{IN} = 3.6\text{ V}$, Buck $V_{OUT} 1.8\text{ V}$,
 Buck $I_{LOAD} = 60\text{ mA}$

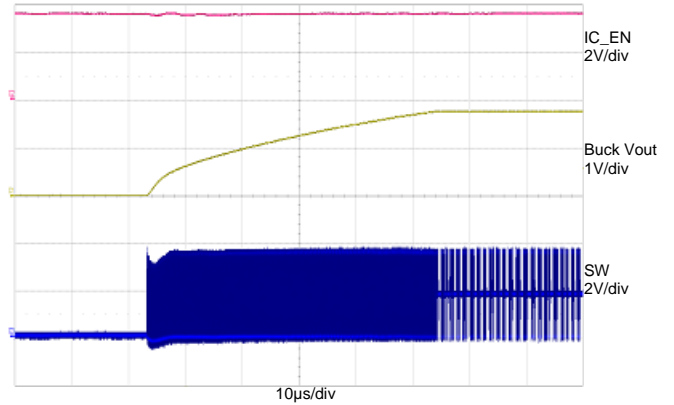

Figure 35: V_{OUT} ramp-up after Enabled
 (Zoom-in of [Figure34](#))

High Efficiency, Ultra-Low Quiescent Current and Ultra-Low Output Ripple Buck Regulator

NDA Confidential

10 Feature Descriptions

10.1 Chip Enable and Disable Through IC_EN

DA9232 features a dedicated IC_EN pin to enable and disable the chip. When IC_EN = high, the device is turned on. IC_EN voltage should not exceed VDD_SYS voltage on the device. When EN = low, the device is shut down completely, including I²C communications.

10.2 VDD Under-Voltage Lockout

DA9232 features an under-voltage lockout (UVLO) on VDD. When VDD falls below UVLO falling threshold, buck is disabled, see Section 10.3.9 for fault behaviour and control, A VIN_UV_Event will be flagged if it is not masked. When VDD rises above the UVLO rising threshold, the device will be alive. VDD should be always tied to VDD_SYS on the PCB board so both VDD and VDD_SYS will share the same UVLO protection.

10.3 Buck Regulator

DA9232 includes a nano-ampere standby buck regulator with an adjustable output voltage, Dynamic Voltage Scaling capability and a maximum load current of 60 mA. It also has power saving mode operation and different protection features.

10.3.1 Buck Output Voltage Programmability

The DA9232 buck regulator can be set to two different ranges based on the value of VOUT_RANGE_HI. The value of BUCK_VOUT<4:0> is locked to a certain range based on the value of VOUT_RANGE_HI, and VOUT_RANGE_HI can only be changed while the buck is disabled. The buck can be set to the output voltages shown in Table 11. If a command is received outside of the allowable range (that is above 1.3 V for VOUT_RANGE_HI = 0 or below 1.3 V for VOUT_RANGE_HI = 1), digital will force the value of BUCK_VOUT<3:0> to 01110 (1.3 V).

Table 11: Buck Output Voltage Settings

VOUT_RANGE_HI	BUCK_VOUT<4:0>	Buck Output Voltage (V)
0	00000	0.60
0	00001	0.65
0	00010	0.70
0	00011	0.75
0	00100	0.80
0	00101	0.85
0	00110	0.90
0	00111	0.95
0	01000	1.00
0	01001	1.05

High Efficiency, Ultra-Low Quiescent Current and Ultra-Low Output Ripple Buck Regulator

NDA Confidential

VOUT_RANGE_HI	BUCK_VOUT<4:0>	Buck Output Voltage (V)
0	01010	1.10
0	01011	1.15
0	01100	1.20
0	01101	1.25
0 or 1	01110	1.30
1	01111	1.35
1	10000	1.40
1	10001	1.45
1	10010	1.50
1	10011	1.55
1	10100	1.60
1	10101	1.65
1	10110	1.70
1	10111	1.75
1	11000	1.80
1	11001	1.85
1	11010	1.90
1	11011	1.90
1	11100	1.90
1	11101	1.90
1	11110	1.90
1	11111	1.90

10.3.2 Start-up Operation

DA9232 buck integrates a start-up circuit to minimize output voltage over-shoot and input voltage drop during start-up. When writing 1 to BUCK_EN (Bit 7 of Reg0x05), the buck is enabled and starts switching after a typical delay time of 3 ms. During start-up, the cycle-by-cycle current limit is reduced to limit inrush current.

10.3.3 Power Saving Mode Operation

DA9232 buck regulator features power saving mode that greatly reduces the quiescent current when device has very light load condition. Buck regulator operates in discontinuous mode with Pulse Frequency Modulation (PFM). The low-side FET will be turned off based on a zero-crossing comparator to prevent negative inductor current flowing through the FET which can result in additional conduction loss. If both FETs remain in the OFF state for a certain delay time after inductor

High Efficiency, Ultra-Low Quiescent Current and Ultra-Low Output Ripple Buck Regulator

NDA Confidential

current crosses zero, the device will enter power saving mode. In power saving mode, DA9232 shuts down most of the internal circuitry to save current consumption. The lighter the load, the longer the duration of power saving mode will be, to achieve the lowest quiescent current and improve light load efficiency.

10.3.4 Dynamic Voltage Control

DA9232 buck regulator has dynamic voltage control (DVC) feature which allows the buck output voltage to track the internal reference voltage when it changes at a rate of 50 mV/2 ms. Since the buck output voltage can only be changed within an allowable range while still keeping the buck enabled, DVC also follows the same behaviour. The DVC is done via I²C, whereby the buck output voltage setting is stepped in 50 mV steps within either the low range or high range. Each voltage step lasts for 2 ms.

10.3.5 Cycle-by-cycle Over-Current Protection

For the Over-current Protection (OCP) in DA9232, the peak current through high-side FET is monitored cycle-by-cycle. When the sensed current exceeds the pre-set current limit, the high-side FET will be turned OFF immediately to limit the inductor current. The high-side FET will be turned on again after the constant-off time expires. If the OC condition persists for 64 μ s, buck will be forced off and buck output will be pull-down until the fault clears, see Section 10.3.9 for fault behavior and control and Section 10.3.8 for output voltage discharge and control. An OC_BUCK_Event will be flagged if it is not masked.

10.3.6 Output Over-Voltage Protection

DA9232 features an output over-voltage protection (OVP) to protect the load from damage. When both IC_EN and BUCK_EN are high and the buck output voltage is 200 mV greater than the internal reference voltage, the high side FET is immediately OFF, see Section 10.3.9 for fault behavior and control. Then the internal buck output discharge FET will be turned on to discharge buck output capacitor, see Section 10.3.8 for output voltage discharge and control. An OV_BUCK_Event will be flagged if it is not masked. Buck will remain off and buck output will be pull-down until the fault is cleared.

10.3.7 Output Under-Voltage Protection

When buck output short happens, inductor current will increase until the peak reaches the cycle-by-cycle current limit. Then the high-side FET turns OFF and low-side FET turns on. Since buck output is shorted, inductor current slope is very small during low-side FET on time. The inductor current could gradually go higher and higher. To effectively prevent the inductor current running away at V_{OUT} short condition, buck V_{OUT} is also monitored. If over-current condition happens and buck V_{OUT} drops 400 mV below the reference voltage, the buck regulator will be shut off immediately and an UV_BUCK_Event will be flagged if it is not masked, see Section 10.3.9 for fault behavior and control.

10.3.8 Automatic Output voltage Discharge

To speed up the discharging of buck output capacitor and ensure a safer start-up next time, the buck regulator provides automatic output voltage discharge when IC_EN is pulled low or buck shutdown caused by any fault. Automatic output discharge when buck is forced OFF by fault needs to set register bit BUCK_PD_CFG1 = 0; automatic output discharge when buck is disabled by

High Efficiency, Ultra-Low Quiescent Current and Ultra-Low Output Ripple Buck Regulator NDA Confidential

BUCK_EN = 0 needs to set register bit BUCK_PD_CFG2 = 0. The output of the buck regulator is discharged through VBUCK_SNS pin and an internal buck output discharge FET with typical 33 Ω resistance.

10.3.9 Event Flag and Fault Control

DA9232 has the flexibility for customers to control the behavior of buck when there is a fault condition. There are five register bits (UVLO_FRC_DIS, OV_DIS_BUCK, OC_BUCK_EVENT, SC_DIS_BUCK) controlling whether the buck will be disabled when the corresponding fault condition happens. In addition, users can choose whether to mask or unmask the event flag when the fault condition happens.

When there is a VDD Under-voltage condition, buck will be forced OFF if UVLO_FRC_DIS = 1. Buck will remain alive if UVLO_FRC_DIS = 0. During the VDD Under-voltage condition, the event register bit VIN_UV_EVENT = 1 if the corresponding mask register bit M_VIN_UV is set to 0 otherwise VIN_UV_EVENT = 0.

When there is an over-voltage fault at buck output, buck will be forced OFF if OV_DIS_BUCK = 1. Buck will continue switching if OV_DIS_BUCK = 0. During the fault, OV_BUCK_EVENT is set to 1 if M_OV_BUCK_EVENT = 0 otherwise OV_BUCK_EVENT = 0.

When the over-current condition in buck persists for 64 μ s and M_OC_BUCK_EVENT is set to 0, OC_BUCK_EVENT will be set to 1. If OC_DIS_BUCK = 1, BUCK is forced disabled. If OC_DIS_BUCK = 0, buck will continue switching during the over-current condition.

When there is a buck Output under-voltage condition and M_UV_BUCK_EVENT = 0, UV_BUCK_EVENT is set to 1. If both buck output under-voltage and over-current condition exist and SC_DIS_BUCK = 1, buck will be forced OFF. If SC_DIS_BUCK = 0, buck will continue switching without shutting down by the under-voltage protection.

DA9232 also has a fault recovery mechanism that can be customized through the 3-bits RCVRY_NUM. This value determines the fault recovery trial number for buck and is counted down by every fault that triggers buck OFF. When RCVRY_NUM reaches 0, recovery trial is ended and buck will remain OFF even if the buck enable signals are toggled HI. If RCVRY_NUM is set to 0x7, there will be no count down on the recovery trial number and recovery trail will not be ended. Before RCVRY_NUM reaches 0, buck will be recovered automatically if the fault condition disappears.

Event flags are not automatically cleared when the fault conditions disappear. They have to be cleared by changing the values in register EVENT through I²C.

High Efficiency, Ultra-Low Quiescent Current and Ultra-Low Output Ripple Buck Regulator

NDA Confidential

10.4 I²C Programming

10.4.1 Interface Description

DA9232 includes an I²C compatible interface based on the following signals:

- SCL: standard 400 kHz I²C bus serial clock generated by the Host processor
- SDA: standard 400 kHz I²C bus serial address/data input output

SDA and SCL are open drain I/O terminals. The standard frequency of the I²C bus is 400 kHz in fast mode or 100 kHz in slow mode.

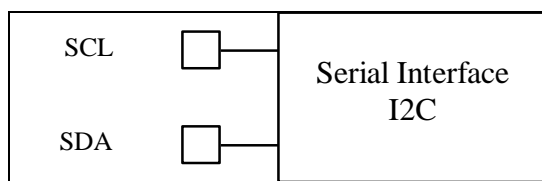

Figure 36: I²C Serial Interface Pins

The I²C bus is used to control most functions and change register values depending on the application requirements. In active battery, the I²C circuitry is powered from the battery. The interface maintains a proper operation as long as VDD_SYS is valid.

The device is compatible with the standard I²C protocol but only operates as a slave. The transfer protocol is the same whether operating in fast or slow mode.

10.4.2 Details of the I²C Protocol

The device supports 7-bit addressing only, the address is 0x2F. The 8-bit shifted address is 0x5E. A timer runs during I²C transitions. If the timer expires while SDA is held low, all additional commands are ignored and the I²C state machine is reset. The timer is reset with a START condition and stopped with a STOP condition.

The I²C bus is monitored at all times for a valid SLAVE address, and an acknowledge bit is generated if the SLAVE address was true.

- A START condition is initiated by a high to low transition on the SDA line while the SCL is in the high state.
- A STOP condition is indicated by a low to high transition on the SDA line while the SCL is in the high state.
- An ACKNOWLEDGE is indicated by the receiver pulling the SDA line low during the following clock cycle.

High Efficiency, Ultra-Low Quiescent Current and Ultra-Low Output Ripple Buck Regulator NDA Confidential

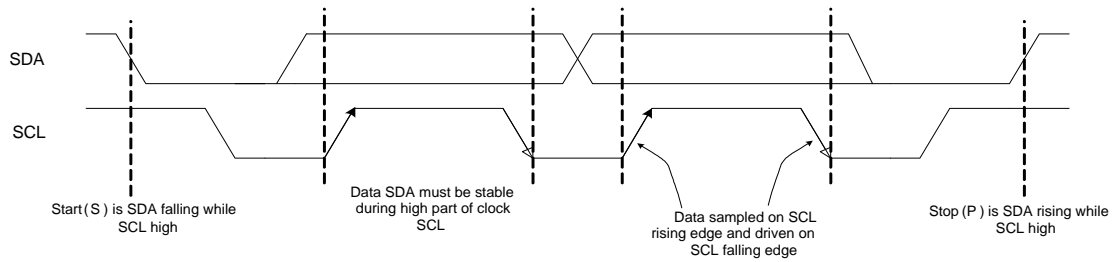

Figure 37: I²C Start and Stop Conditions

High Efficiency, Ultra-Low Quiescent Current and Ultra-Low Output Ripple Buck Regulator

NDA Confidential

When the address is matching the following event sequence happens:

1. The device generates an ACKNOWLEDGE to indicate to the master that the communication link has been established
2. The master generates SCL clock cycles to transmit or receive data
3. After receiving data, an ACKNOWLEDGE is generated either by the device or the master (whichever is transmitting the data)
A data sequence is 9-bit, consisting of 8-bit data and 1-bit ACKNOWLEDGE. It can be repeated as long as necessary.
4. The master generates a STOP condition to end the data transfer

The bus returns to IDLE-mode if during a message a new START or STOP condition occurs. Data is transmitted MSB first for both R/W operations.

10.5 GPO Pin Function Programming

DA9232 has a General-purpose output (GPO) pin which can be programmed to have multiple functions.

10.5.1 Power Good Indicator

When GPO pin is configured to the VDD power good indicator, it is an open drain output and can be configured to either active high or active low. When GPO status is Hi-Z, an external pull-up is required for GPO to be high.

Table 12: GPO as Power Good Indicator

GPO Configuration	$V_{IN} > V_{IN_UVLO}$	GPO Status
Active High	No	0
	Yes	Hi-Z
Active Low	No	Hi-Z
	Yes	0

10.5.2 Event Indicator

GPO pin can also be configured as the event indicator in open drain output. Whenever there is an event or multiple events (VIN_UV_EVNT or OV_BUCK_EVENT or OC_BUCK_EVENT or UV_BUCK_EVENT) happen, GPO will be pulled down Low. This can be used as an interrupt to host CPU to inform events happened. When there is no event, GPO will remain in Hi-Z status and an external pull-up is required for GPO to be high.

10.5.3 Reset Pulse Generation

GPO pin can be configured to generate a reset pulse signal when buck starts. The reset signal can be used by host CPU or other device that are connected to buck output. When GPO is Low, it indicates a reset pulse period; when GPO is in Hi-Z status (An external pull-up is required for GPO to be high), it indicates a non-reset period.

There is also a timing control to negate the reset pulse signal. The GPO reset pulse width can be adjusted between 8 and 112 ms measured from written 1 to BUCK_EN register bit.

High Efficiency, Ultra-Low Quiescent Current and Ultra-Low Output Ripple Buck Regulator NDA Confidential**10.5.4 Always Pull-Down or Hi-Z**

When GPO pin is not used, it can be configured to either always Hi-Z or pull-down to Low.

High Efficiency, Ultra-Low Quiescent Current and Ultra-Low Output Ripple Buck Regulator

NDA Confidential

11 Register Overview

11.1 Register Map

11.1.1 Buck Control

Table 13: Event/Status/Mask and User Registers

User Registers									
Register	Addr	7	6	5	4	3	2	1	0
EVENT	0x0000	Reserved	VIN_UV_EVENT	Reserved	OC_BUCK_EVENT	OV_BUCK_EVENT	UV_BUCK_EVENT	Reserved	Reserved
STATUS	0x0002	Reserved	VIN_UV_STAT	Reserved	OC_BUCK_STAT	OV_BUCK_STAT	UV_BUCK_STAT	Reserved	BUCK_EN_STAT
MASK	0x0003	Reserved	M_VIN_UV	Reserved	M_OC_BUCK_EVENT	M_OV_BUCK_EVENT	M_UV_BUCK_EVENT	Reserved	Reserved
GPO	0x0004	GPO_RST_CTRL<3:0>				GPO_CTRL<3:0>			
BUCK	0x0005	BUCK_EN	VOUT_RANGE_HI	Reserved	BUCK_VOUT<4:0>				
BUCK_CFG	0x0006	Reserved	Reserved	BUCK_PD_CFG2	BUCK_PD_CFG1	Reserved	Reserved	SEL_BUCK_ILIM<1:0>	
FAULT_CTL	0x0008	SC_DIS_BUCK	OC_DIS_BUCK	OV_DIS_BUCK	TSD_FRC_DIS	UVLO_FRC_DIS	RCVRY_NUM<2:0>		
PIN_MONTOR	0x000A	Reserved	Reserved	Reserved	Reserved	Reserved	Reserved	Reserved	GPO_OUT_MON

High Efficiency, Ultra-Low Quiescent Current and Ultra-Low Output Ripple Buck Regulator

NDA Confidential

11.1.2 System Module

Table 14: System Reset Registers

User Registers									
Register	Addr	7	6	5	4	3	2	1	0
SYS_RST_EVENT	0x0001	Reserved	Reserved	Reserved	Reserved	Reserved	Reserved	Reserved	RESET_EVENT
SYS_SRST	0x0009	Reserved	Reserved	Reserved	Reserved	SRST<3:0>			
SYS_DEVICE_ID	0x0080	DEV_ID<7:0>							
SYS_VARIANT_ID	0x0081	MRC<3:0>				VRC<3:0>			
SYS_CONFIG_ID	0x0082	CONFIG_REV<7:0>							

11.2 Register Definitions

11.2.1 Buck Control

11.2.1.1 Event/Status/Mask Registers

Table 15: Register EVENT

Address	Register Name	POR Value	Event flag						
0x0000	EVENT	0x00							
7	6	5	4	3	2	1	0		
Reserved	VIN_UV_EVENT	Reserved	OC_BUCK_EVENT	OV_BUCK_EVENT	UV_BUCK_EVENT	Reserved	Reserved		

High Efficiency, Ultra-Low Quiescent Current and Ultra- Low Output Ripple Buck Regulator

NDA Confidential

Field Name	Bits	Type	POR	Description
VIN_UV_EVENT	[6]	evnt	0x0	Under Voltage on VDD event flag. When Under Voltage (UVLO) condition is detected, this bit is set to 1. When I2C writes '1' to this bit, the event flag is cleared.
OC_BUCK_EVENT	[4]	evnt	0x0	Over Current on BUCK OUT event flag. When the buck Over Current condition is detected (when BUCK_EN==1 && M_OC_BUCK==0), this bit is set to 1. When I2C writes '1' to this bit, the event flag is cleared.
OV_BUCK_EVENT	[3]	evnt	0x0	Over Voltage on BUCK OUT event flag. When the buck Over Voltage condition is detected (when BUCK_EN==1 && M_OV_BUCK==0), this bit is set to 1. When I2C writes '1' to this bit, the event flag is cleared.
UV_BUCK_EVENT	[2]	evnt	0x0	Under voltage on BUCK OUT event flag. When the under voltage condition (i.e. short circuit) is detected on the buck (when BUCK_EN==1 && M_UV_BUCK==0), this bit is set to 1. When I2C writes '1' to this bit, this event flag is cleared.

Table 16: Register STATUS

Address	Register Name	POR Value	Status				
0x0002	STATUS	0x00					
7	6	5	4	3	2	1	0
Reserved	VIN_UV_STAT	Reserved	OC_BUCK_STAT	OV_BUCK_STAT	UV_BUCK_STAT	Reserved	BUCK_EN_STAT
Field Name	Bits	Type	POR	Description			
VIN_UV_STAT	[6]	virtual	0x0	Indicate present V_{IN} under-voltage status.			
OC_BUCK_STAT	[4]	virtual	0x0	Indicate present BUCK VOUT over current status.			
OV_BUCK_STAT	[3]	virtual	0x0	Indicate present BUCK VOUT over voltage status.			

High Efficiency, Ultra-Low Quiescent Current and Ultra- Low Output Ripple Buck Regulator

NDA Confidential

Field Name	Bits	Type	POR	Description
UV_BUCK_STAT	[2]	virtual	0x0	Indicate present BUCK VOUT under voltage status.
BUCK_EN_STAT	[0]	virtual	0x0	Indicate present Buck Enable status. 1:Buck enabled 0:Buck disabled

Table 17: Register MASK

Address	Register Name	POR Value	Mask				
0x0003	MASK	0x7C					
7	6	5	4	3	2	1	0
Reserved	M_VIN_UV	Reserved	M_OC_BUCK_EVENT	M_OV_BUCK_EVENT	M_UV_BUCK_EVENT	Reserved	Reserved
Field Name	Bits	Type	POR	Description			
M_VIN_UV	[6]	cfg OTP	0x1	Mask to set VIN_UV_EVNT. VIN_UV_STAT is updated regardless of this mask.			
M_OC_BUCK_EVENT	[4]	cfg OTP	0x1	Masks to set OC_BUCK_EVENT. OC_BUCK_STAT is updated regardless of this mask.			
M_OV_BUCK_EVENT	[3]	cfg OTP	0x1	Masks to set OV_BUCK_EVENT. OV_BUCK_STAT is updated regardless of this mask.			
M_UV_BUCK_EVENT	[2]	cfg OTP	0x1	Masks to set UV_BUCK_EVENT. UV_BUCK_STAT is updated regardless of this mask.			

High Efficiency, Ultra-Low Quiescent Current and Ultra- Low Output Ripple Buck Regulator

NDA Confidential

11.2.1.2 User Registers

Table 18: Register GPO

Address	Register Name	POR Value	GPO control				
0x0004	GPO	0x00					
7	6	5	4	3	2	1	0
GPO_RST_CTRL<3:0>				GPO_CTRL<3:0>			
Field Name	Bits	Type	POR	Description			
GPO_RST_CTRL	[7:4]	cfg OTP	0x0	Reset pulse signal nagate timing control			
				Value	Description		
				0x0	8ms after BUCK_EN = 1, GPO reset pulse is negated.		
				0x1	16ms after BUCK_EN = 1, GPO reset pulse is negated.		
				0x2	32ms after BUCK_EN = 1, GPO reset pulse is negated.		
				0x3	48ms after BUCK_EN = 1, GPO reset pulse is negated.		
				0x4	64ms after BUCK_EN = 1, GPO reset pulse is negated.		
				0x5	80ms after BUCK_EN = 1, GPO reset pulse is negated.		
				0x6	96ms after BUCK_EN = 1, GPO reset pulse is negated.		
0x7	112ms after BUCK_EN = 1, GPO reset pulse is negated.						
GPO_CTRL	[3:0]	cfg OTP	0x0	GPO Control			
				Value	Description		

High Efficiency, Ultra-Low Quiescent Current and Ultra- Low Output Ripple Buck Regulator

NDA Confidential

Field Name	Bits	Type	POR	Description
				0x1 Reset Pulse generation output
				0x2 PowerGood indicator, Active Low
				0x3 PowerGood indicator, Active High
				0x4 Event indicator
				0x8 Force GPO output low
				0x9 Force GPO output hi-z

Table 19: Register BUCK

Address	Register Name	POR Value					
0x0005	BUCK	0x58	Buck enable & vout control				
7	6	5	4	3	2	1	0
BUCK_EN	VOUT_RANGE_HI	Reserved	BUCK_VOUT<4:0>				
Field Name	Bits	Type	POR	Description			
BUCK_EN	[7]	cfg OTP	0x0	BUCK enable			
VOUT_RANGE_HI	[6]	cfg OTP	0x1	Range selection for buck. This can only be changed while BUCK_EN = 0			
				Value	Description		
				0x0	0.60 V <= VBUCK <= 1.30 V		
				0x1	1.30 V <= VBUCK <= 1.90 V		
BUCK_VOUT	[4:0]	datablk OTP	0x18	Buck output voltage			

High Efficiency, Ultra-Low Quiescent Current and Ultra- Low Output Ripple Buck Regulator NDA Confidential

Value	Description
0x00	0.60 V
0x01	0.65 V
0x02	0.70 V
0x03	0.75 V
0x04	0.80 V
0x05	0.85 V
0x06	0.90 V
0x07	0.95 V
0x08	1.00 V
0x09	1.05 V
0x0A	1.10 V
0x0B	1.15 V
0x0C	1.20 V
0x0D	1.25 V
0x0E	1.30 V
0x0F	1.35 V
0x10	1.40 V
0x11	1.45 V
0x12	1.50 V

High Efficiency, Ultra-Low Quiescent Current and Ultra- Low Output Ripple Buck Regulator

NDA Confidential

Field Name	Bits	Type	POR	Description
				0x13 1.55 V
				0x14 1.60 V
				0x15 1.65 V
				0x16 1.70 V
				0x17 1.75 V
				0x18 1.80 V
				0x19 1.85 V
				0x1A 1.90 V
				0x1B 1.90 V
				0x1C 1.90 V
				0x1D 1.90 V
				0x1E 1.90 V
				0x1F 1.90 V

Table 20: Register BUCK_CFG

Address	Register Name	POR Value	Buck config				
0x0006	BUCK_CFG	0x00					
7	6	5	4	3	2	1	0
Reserved	Reserved	BUCK_PD_CFG2	BUCK_PD_CFG1	Reserved	Reserved	SEL_BUCK_ILIM<1:0>	

High Efficiency, Ultra-Low Quiescent Current and Ultra- Low Output Ripple Buck Regulator

NDA Confidential

Field Name	Bits	Type	POR	Description	
BUCK_PD_CFG2	[5]	cfg OTP	0x0	0: If BUCK_EN = 0, BUCK_PD_EN = 1 1: If BUCK_EN = 0, BUCK_PD_EN = 0	
BUCK_PD_CFG1	[4]	cfg OTP	0x0	0: When BUCK is forced off by faults, BUCK_PD_EN = 1 1: When BUCK is forced off by faults, BUCK_PD_EN = 0	
SEL_BUCK_ILIM	[1:0]	cfg OTP	0x0	Buck peak current limit setting	
				Value	Description
				0x0	Default current limit
				0x1	Default +50mA
				0x2	Default +100mA
0x3	Default +150mA				

Table 21: Register FAUL_CTL

Address	Register Name	POR Value	Fault & Recovery control				
0x0008	FAUL_CTL	0x1F					
7	6	5	4	3	2	1	0
SC_DIS_BUCK	OC_DIS_BUCK	OV_DIS_BUCK	TSD_FRC_DIS	UVLO_FRC_DIS	RCVRY_NUM<2:0>		
Field Name	Bits	Type	POR	Description			
SC_DIS_BUCK	[7]	cfg OTP	0x0	1: Force disable BUCK during SHORT CIRCUIT condition oc_buck=1 & uv_buck=1			
OC_DIS_BUCK	[6]	cfg OTP	0x0	1: Force disable BUCK during oc_buck=1 for over 64 cycles			
OV_DIS_BUCK	[5]	cfg OTP	0x0	1: Force disable BUCK during ov_buck=1			
TSD_FRC_DIS	[4]	cfg OTP	0x1	1: Force disable BUCK during Over Temp			

High Efficiency, Ultra-Low Quiescent Current and Ultra- Low Output Ripple Buck Regulator

NDA Confidential

Field Name	Bits	Type	POR	Description
UVLO_FRC_DIS	[3]	cfg OTP	0x1	1: Force disable BUCK during UVLO
RCVRY_NUM	[2:0]	data OTP	0x7	BUCK recovery trial fault number. This is counted down by every fault forcing BUCK off. If RCVRY_NUM becomes 0, Recovery trial is ended. If RCVRY_NUM is set 0x7, this is not counted down and recovery trail is not ended.

Table 22: Register PIN_MONITOR

Address	Register Name	POR Value	PIN MONITOR				
0x000A	PIN_MONTOR	0x00					
7	6	5	4	3	2	1	0
Reserved	Reserved	Reserved	Reserved	Reserved	Reserved	Reserved	GPO_OUT_MON
Field Name	Bits	Type	POR	Description			
GPO_OUT_MON	[0]	virtual	0x0	Indicate current GPO output			

11.2.2 System Module

11.2.2.1 System Reset Registers

Table 23: Register SYS_RST_EVENT

Address	Register Name	POR Value	Reset Event flag				
0x0001	SYS_RST_EVENT	0x01					
7	6	5	4	3	2	1	0
Reserved	Reserved	Reserved	Reserved	Reserved	Reserved	Reserved	RESET_EVENT

High Efficiency, Ultra-Low Quiescent Current and Ultra- Low Output Ripple Buck Regulator

NDA Confidential

Field Name	Bits	Type	POR	Description
RESET_EVENT	[0]	evnt	0x1	RESET event flag. After Reset, this bit is set. When I2C write '1' to this bit, this event flag is cleared.

Table 24: Register SYS_SRST

Address	Register Name	POR Value	Soft Reset				
0x0009	SYS_SRST	0x00					
7	6	5	4	3	2	1	0
Reserved	Reserved	Reserved	Reserved	SRST<3:0>			
Field Name	Bits	Type	POR	Description			
SRST	[3:0]	cfg	0x0	Initiate Soft Reset by writing 0x5.			

11.2.2.2 System ID Registers

Table 25: Register SYS_DEVICE_ID

Address	Register Name	POR Value	DEVICE_ID				
0x0080	SYS_DEVICE_ID	0x00					
7	6	5	4	3	2	1	0
DEV_ID<7:0>							
Field Name	Bits	Type	POR	Description			
DEV_ID	[7:0]	virtual	0x0	Device ID; hard-coded or metal-programmed			

High Efficiency, Ultra-Low Quiescent Current and Ultra- Low Output Ripple Buck Regulator

NDA Confidential

Table 26: Register SYS_VARIANT_ID

Address	Register Name	POR Value	VARIANT_ID				
0x0081	SYS_VARIANT_ID	0x00					
7	6	5	4	3	2	1	0
MRC<3:0>				VRC<3:0>			
Field Name	Bits	Type	POR	Description			
MRC	[7:4]	virtual	0x0	Mask Revision Code; mask design changes increment reset value.			
VRC	[3:0]	trim OTP	0x0	Chip Variant Code; e.g. package variants.			

Table 27: Register SYS_CONFIG_ID

Address	Register Name	POR Value	CONFIG_ID				
0x0082	SYS_CONFIG_ID	0x00					
7	6	5	4	3	2	1	0
CONFIG_REV<7:0>							
Field Name	Bits	Type	POR	Description			
CONFIG_REV	[7:0]	trim OTP	0x0	OTP settings revision			

High Efficiency, Ultra-Low Quiescent Current and Ultra- Low Output Ripple Buck Regulator NDA Confidential

12 Package Information

12.1 Package Outlines

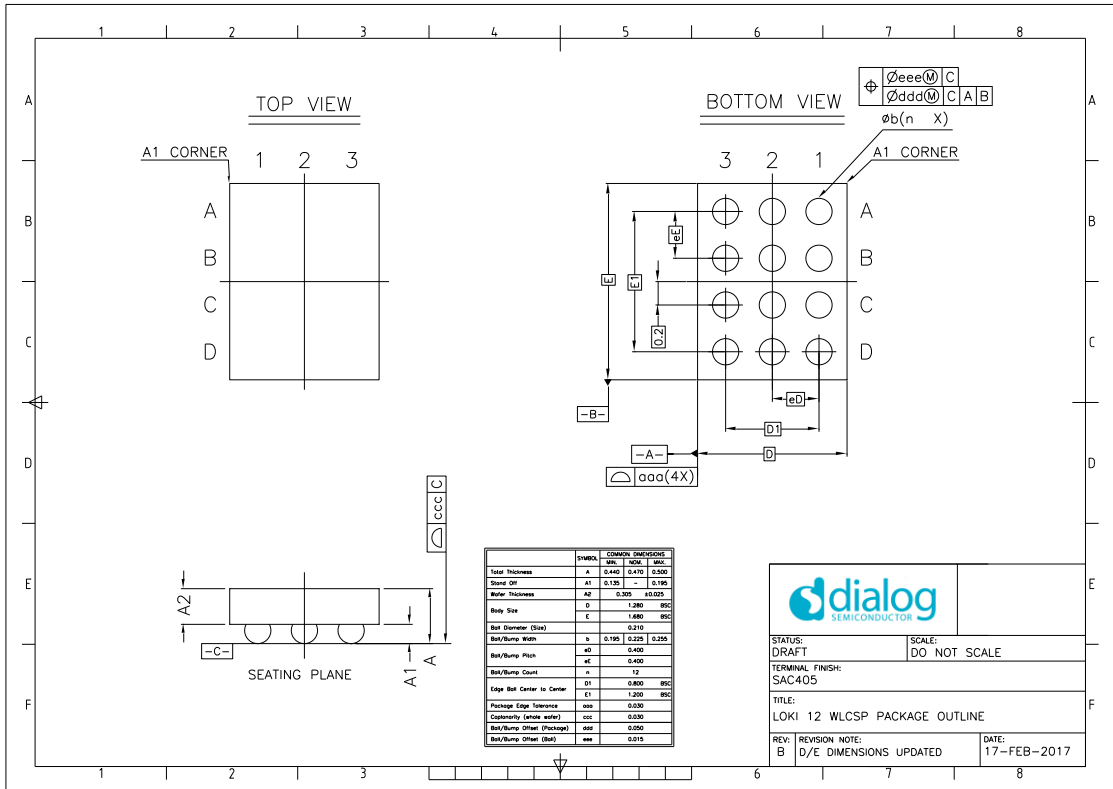

Figure 38: Package Outline Drawing

High Efficiency, Ultra-Low Quiescent Current and Ultra-Low Output Ripple Buck Regulator NDA Confidential

12.2 Moisture Sensitivity Level

The Moisture Sensitivity Level (MSL) is an indicator for the maximum allowable time period (floor lifetime) in which a moisture sensitive plastic device, once removed from the dry bag, can be exposed to an environment with a maximum temperature of 30 °C and a maximum relative humidity of 60% RH before the solder reflow process. The MSL classification is defined in [Table 28](#).

The device package is qualified for MSL 1.

Table 28: MSL Classification

MSL level	Floor Lifetime
MSL 1	unlimited at 30 °C/85% RH

12.3 Soldering Information

Refer to the JEDEC standard J-STD-020 for relevant soldering information. This document can be downloaded from <http://www.jedec.org>.

High Efficiency, Ultra-Low Quiescent Current and Ultra-Low Output Ripple Buck Regulator

NDA Confidential

13 Ordering Information

The ordering number consists of the part number followed by a suffix indicating the packing method. For details and availability or other custom OTP parts, please consult Dialog Semiconductor's [customer portal](#) or your local sales representative.

Table 29: Ordering Information

Part number	Package	Size (mm)	Shipment Form	Pack Quantity
DA9232 -xxxx	WLCSP-12	1.3 x 1.7	T&R	4500

Table 30: OTP List

Order code	Description	Buck V _{out}
DA9232-81VZ2	OTP with buck voltage preconfigured	1.8 V
DA9232-82VZ2	OTP with buck voltage preconfigured	0.7 V

High Efficiency, Ultra-Low Quiescent Current and Ultra-Low Output Ripple Buck Regulator NDA Confidential

Status Definitions

Revision	Datasheet Status	Product Status	Definition
1.<n>	Target	Development	This datasheet contains the design specifications for product development. Specifications may be changed in any manner without notice.
2.<n>	Preliminary	Qualification	This datasheet contains the specifications and preliminary characterization data for products in pre-production. Specifications may be changed at any time without notice in order to improve the design.
3.<n>	Final	Production	This datasheet contains the final specifications for products in volume production. The specifications may be changed at any time in order to improve the design, manufacturing and supply. Relevant changes will be communicated via Customer Product Notifications.
4.<n>	Obsolete	Archived	This datasheet contains the specifications for discontinued products. The information is provided for reference only.

Important Notice and Disclaimer

RENESAS ELECTRONICS CORPORATION AND ITS SUBSIDIARIES (“RENESAS”) PROVIDES TECHNICAL SPECIFICATIONS AND RELIABILITY DATA (INCLUDING DATASHEETS), DESIGN RESOURCES (INCLUDING REFERENCE DESIGNS), APPLICATION OR OTHER DESIGN ADVICE, WEB TOOLS, SAFETY INFORMATION, AND OTHER RESOURCES “AS IS” AND WITH ALL FAULTS, AND DISCLAIMS ALL WARRANTIES, EXPRESS OR IMPLIED, INCLUDING, WITHOUT LIMITATION, ANY IMPLIED WARRANTIES OF MERCHANTABILITY, FITNESS FOR A PARTICULAR PURPOSE, OR NON-INFRINGEMENT OF THIRD PARTY INTELLECTUAL PROPERTY RIGHTS.

These resources are intended for developers skilled in the art designing with Renesas products. You are solely responsible for (1) selecting the appropriate products for your application, (2) designing, validating, and testing your application, and (3) ensuring your application meets applicable standards, and any other safety, security, or other requirements. These resources are subject to change without notice. Renesas grants you permission to use these resources only for development of an application that uses Renesas products. Other reproduction or use of these resources is strictly prohibited. No license is granted to any other Renesas intellectual property or to any third party intellectual property. Renesas disclaims responsibility for, and you will fully indemnify Renesas and its representatives against, any claims, damages, costs, losses, or liabilities arising out of your use of these resources. Renesas' products are provided only subject to Renesas' Terms and Conditions of Sale or other applicable terms agreed to in writing. No use of any Renesas resources expands or otherwise alters any applicable warranties or warranty disclaimers for these products.

© 2022 Renesas Electronics Corporation. All rights reserved.

RoHS Compliance

Dialog Semiconductor's suppliers certify that its products are in compliance with the requirements of Directive 2011/65/EU of the European Parliament on the restriction of the use of certain hazardous substances in electrical and electronic equipment. RoHS certificates from our suppliers are available on request.

(Rev.1.0 Mar 2020)

Corporate Headquarters

TOYOSU FORESIA, 3-2-24 Toyosu

Koto-ku, Tokyo 135-0061, Japan

www.renesas.com

Contact Information

For further information on a product, technology, the most up-to-date version of a document, or your nearest sales office, please visit:

<https://www.renesas.com/contact/>

Trademarks

Renesas and the Renesas logo are trademarks of Renesas Electronics Corporation. All trademarks and registered trademarks are the property of their respective owners.

