



**SINGLE-PHASE GLASS PASSIVATED
SILICON BRIDGE RECTIFIER**
VOLTAGE RANGE 50 to 1000 Volts CURRENT 1.5 Amperes

**DB151LS
THRU
DB157LS**

FEATURES

- * Good for automation insertion
- * Surge overload rating - 40 amperes peak
- * Ideal for printed circuit board
- * Reliable low cost construction utilizing molded
- * Glass passivated device
- * Polarity symbols molded on body
- * Mounting position: Any
- * Weight: 1.0 gram

MECHANICAL DATA

- * Epoxy: Device has UL flammability classification 94V-O

MAXIMUM RATINGS AND ELECTRICAL CHARACTERISTICS

Ratings at 25 °C ambient temperature unless otherwise specified.
resistive or inductive load.

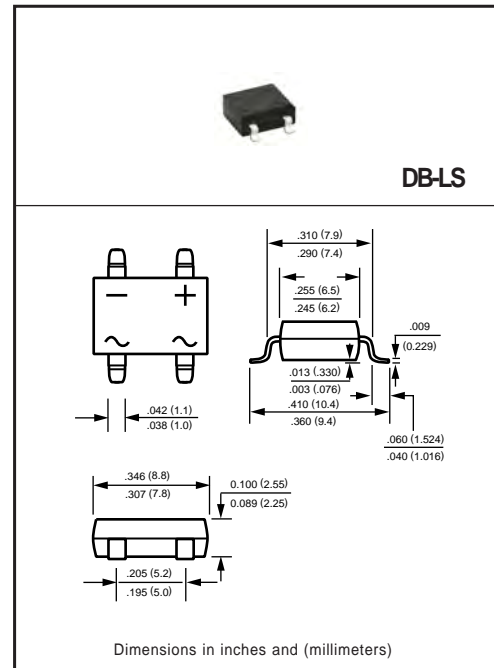

MAXIMUM RATINGS (At $T_A = 25^\circ\text{C}$ unless otherwise noted)

RATINGS	SYMBOL	DB151LS	DB152LS	DB153LS	DB154LS	DB155LS	DB156LS	DB157LS	UNITS
Maximum Recurrent Peak Reverse Voltage	V_{RRM}	50	100	200	400	600	800	1000	Volts
Maximum RMS Bridge Input Voltage	V_{RMS}	35	70	140	280	420	560	700	Volts
Maximum DC Blocking Voltage	V_{DC}	50	100	200	400	600	800	1000	Volts
Maximum Average Forward Output Current at $T_A = 40^\circ\text{C}$	I_O	1.5							Amps
Peak Forward Surge Current 8.3 ms single half sine-wave superimposed on rated load (JEDEC method)	I_{FSM}	40							Amps
Typical Current Squared Time	I^2t	6.6							A^2/Sec
Typical Thermal Resistance (Note 2)	$R_{\theta JA}$	55							$^\circ\text{C}/\text{W}$
	$R_{\theta JL}$	8							
Operating and Storage Temperature Range	T_J, T_{STG}	-55 to + 150							$^\circ\text{C}$

ELECTRICAL CHARACTERISTICS (At $T_A = 25^\circ\text{C}$ unless otherwise noted)

CHARACTERISTICS	SYMBOL	DB151LS	DB152LS	DB153LS	DB154LS	DB155LS	DB156LS	DB157LS	UNITS
Maximum Forward Voltage Drop per Bridge Element at 1.5A DC	V_F	1.1							Volts
Maximum Reverse Current at Rated DC Blocking Voltage per element	@ $T_A = 25^\circ\text{C}$	5.0							μAmps
	@ $T_A = 125^\circ\text{C}$	0.5							mAmps

- Note: 1. "Fully ROHS compliant", "100% Sn plating (Pb-free).
2. Thermal Resistance: Mounted on PCB.
3. Available in Halogen-free epoxy by adding suffix -HF after the part nbr.

RATING AND CHARACTERISTICS CURVES (DB151LS THRU DB157LS)

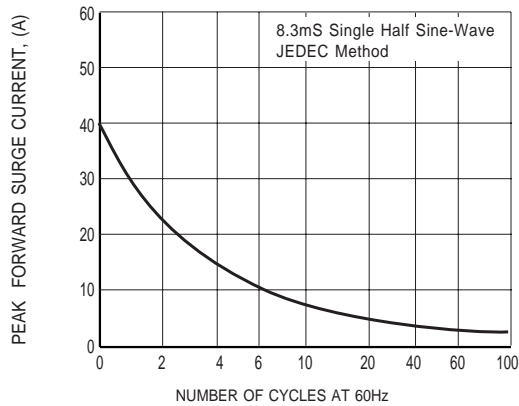

FIG. 1 - MAXIMUM NON-REPETITIVE FORWARD SURGE CURRENT

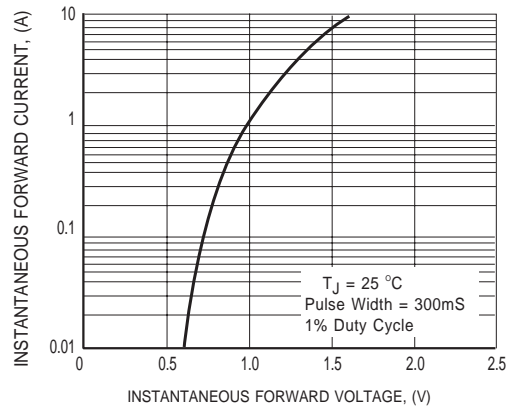

FIG. 2 TYPICAL INSTANTANEOUS FORWARD CHARACTERISTICS

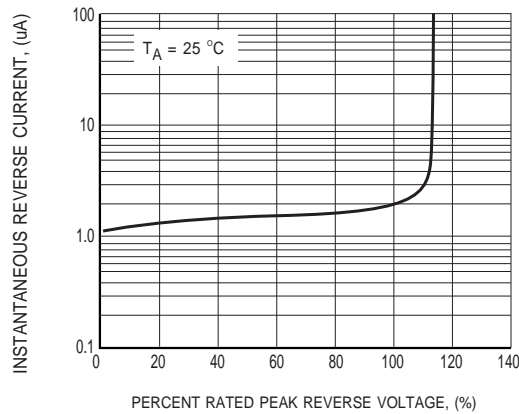

FIG. 3 TYPICAL REVERSE CHARACTERISTICS

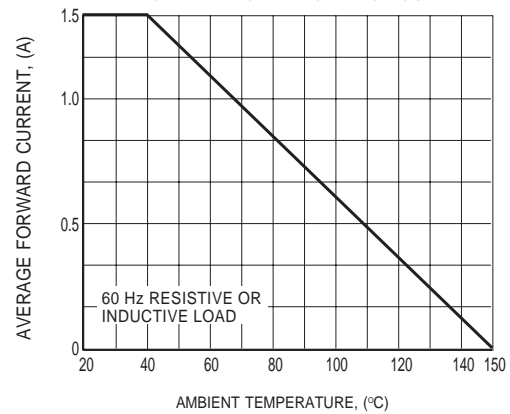
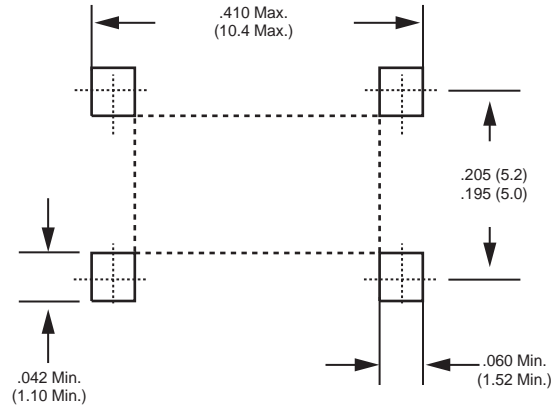

FIG. 4 TYPICAL FORWARD CURRENT DERATING CURVE

Mounting Pad Layout



Dimensions in inches and (millimeters)

Marking Description

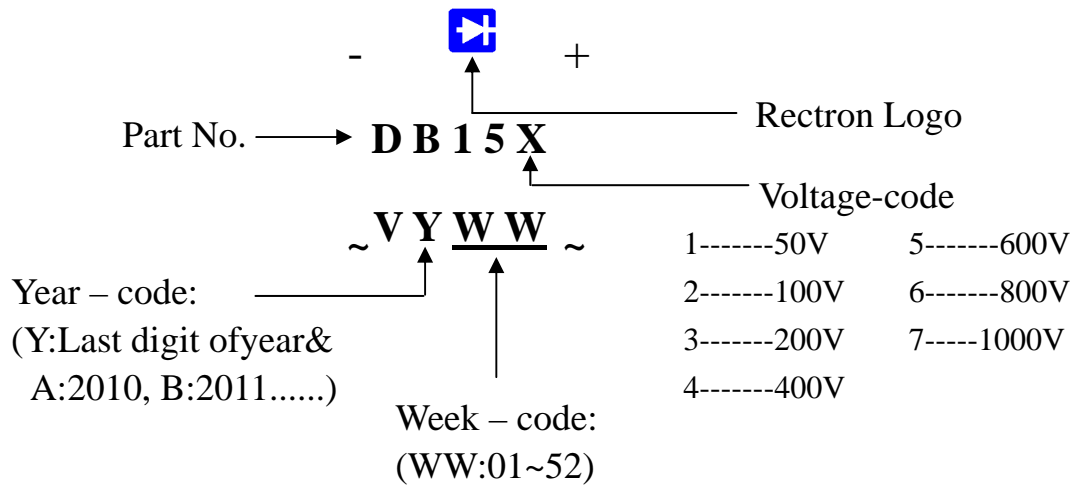

PACKAGING OF DIODE AND BRIDGE RECTIFIERS

TUBE PACK

PACKAGE	PACKING CODE	EA PER BOX	INNER BOX SIZE (mm)	CARTON SIZE (mm)	EA PER CARTON	WEIGHT(Kg)
DB-LS	-C	4,000	450*140*84	464*305*283	24,000	16.45