

## 1A, 50V - 1000V Standard Bridge Rectifier

### FEATURES

- AEC-Q101 qualified available
- Ideal for printed circuit board
- Reliable low cost construction utilizing molded plastic technique
- High surge current capability
- UL Recognized File # E-326854
- Moisture sensitivity level: level 1, per J-STD-020
- RoHS Compliant
- Halogen-free according to IEC 61249-2-21

### APPLICATIONS

- Switching mode power supply (SMPS)
- Adapters
- Lighting application

### MECHANICAL DATA

- Case: DBLS
- Molding compound meets UL 94V-0 flammability rating
- Terminal: Matte tin plated leads, solderable per J-STD-002
- Meet JESD 201 class 2 whisker test
- Polarity: As marked
- Weight: 0.360g (approximately)

KEY PARAMETERS		
PARAMETER	VALUE	UNIT
$I_F$	1	A
$V_{RRM}$	50 - 1000	V
$I_{FSM}$	30, 40	A
$T_{J\ MAX}$	150	°C
Package	DBLS	
Configuration	Quad	

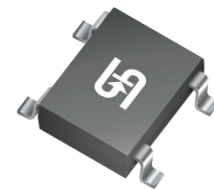
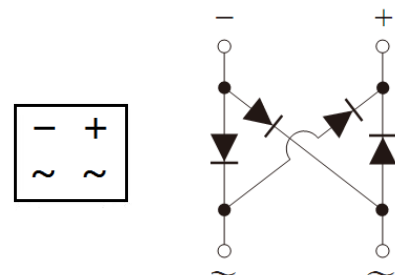
**DBLS**

ABSOLUTE MAXIMUM RATINGS ( $T_A = 25^\circ\text{C}$ unless otherwise noted)									
PARAMETER	SYMBOL	DBLS 101G	DBLS 102G	DBLS 103G	DBLS 104G	DBLS 105G	DBLS 106G	DBLS 107G	UNIT
Marking code on the device		DBLS 101G	DBLS 102G	DBLS 103G	DBLS 104G	DBLS 105G	DBLS 106G	DBLS 107G	
Repetitive peak reverse voltage	$V_{RRM}$	50	100	200	400	600	800	1000	V
Reverse voltage, total rms value	$V_{R(RMS)}$	35	70	140	280	420	560	700	V
Forward current	$I_F$	1							A
Peak forward surge current, 8.3ms single half sine-wave superimposed on rated load	$I_{FSM}$	40					30		A
Rating for fusing ( $t < 8.3\text{ms}$ )	$I^2t$	6.6					3.7		A <sup>2</sup> s
Junction temperature	$T_J$	- 55 to +150							°C
Storage temperature	$T_{STG}$	- 55 to +150							°C

**THERMAL PERFORMANCE**

PARAMETER	SYMBOL	TYP	UNIT
Junction-to-lead thermal resistance	$R_{\theta JL}$	15	°C/W
Junction-to-ambient thermal resistance	$R_{\theta JA}$	40	°C/W

**ELECTRICAL SPECIFICATIONS** ( $T_A = 25^\circ\text{C}$  unless otherwise noted)

PARAMETER	CONDITIONS	SYMBOL	TYP	MAX	UNIT
Forward voltage per diode <sup>(1)</sup>	$I_F = 1\text{A}, T_J = 25^\circ\text{C}$	$V_F$	-	1.1	V
Reverse current @ rated $V_R$ per diode <sup>(2)</sup>	$T_J = 25^\circ\text{C}$	$I_R$	-	2	$\mu\text{A}$
	$T_J = 125^\circ\text{C}$		-	100	$\mu\text{A}$
Junction capacitance per diode	1MHz, $V_R = 4.0\text{V}$	$C_J$	25	-	pF

**Notes:**

1. Pulse test with  $PW = 0.3\text{ms}$
2. Pulse test with  $PW = 30\text{ms}$

**ORDERING INFORMATION**

ORDERING CODE <sup>(1)(2)</sup>	PACKAGE	PACKING
DBLS1xG	DBLS	1,500 / Tape & Reel
DBLS1xGH	DBLS	1,500 / Tape & Reel

**Notes:**

1. "x" defines voltage from 50V(DBLS101G) to 1000V(DBLS107G)
2. "H" means AEC-Q101 qualified

**CHARACTERISTICS CURVES**

( $T_A = 25^\circ\text{C}$  unless otherwise noted)

**Fig.1 Forward Current Derating Curve**

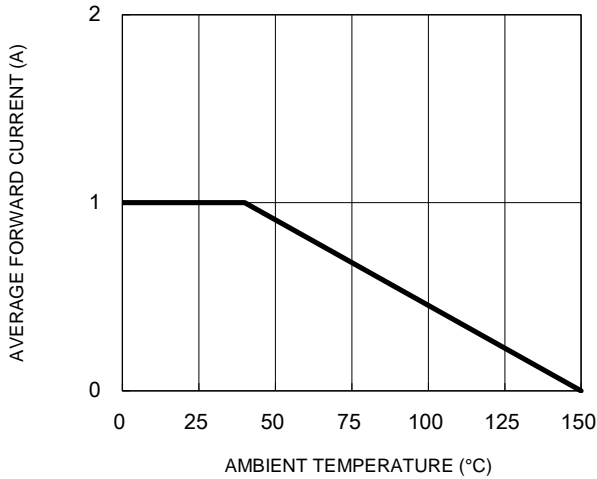

**Fig.2 Typical Junction Capacitance**

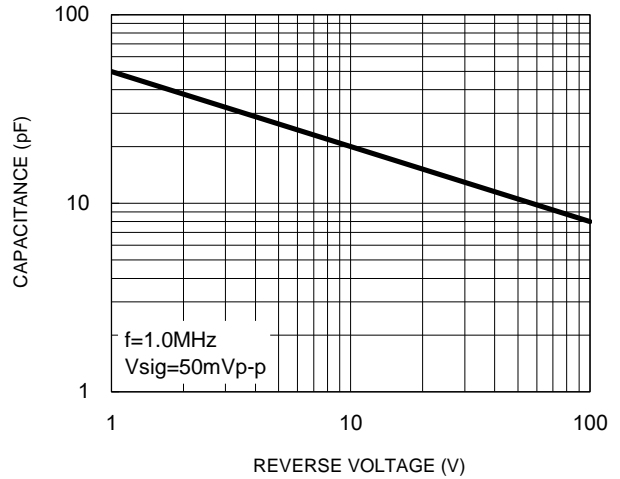

**Fig.3 Typical Reverse Characteristics**

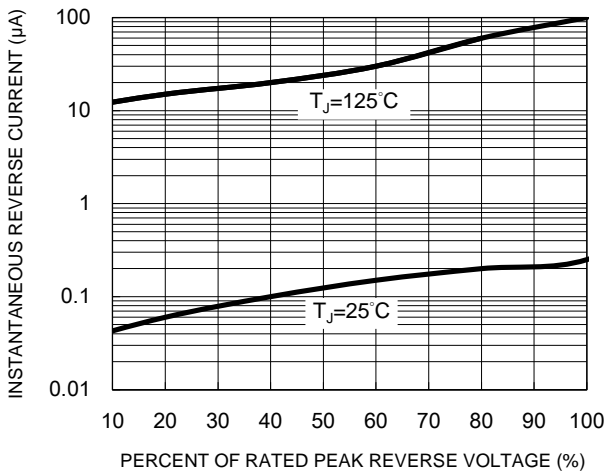

**Fig.4 Typical Forward Characteristics**

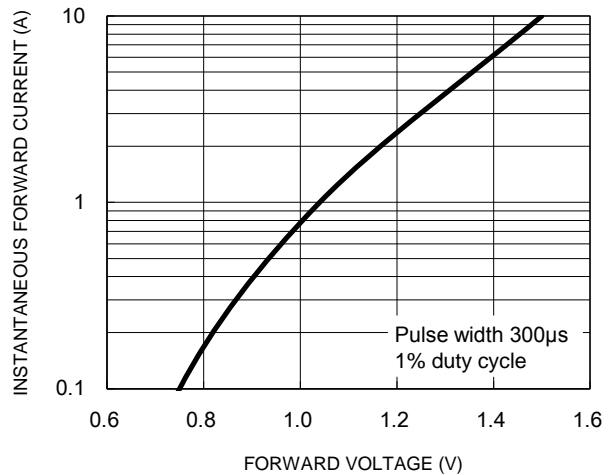

**Fig.5 Maximum Non-Repetitive Forward Surge Current**

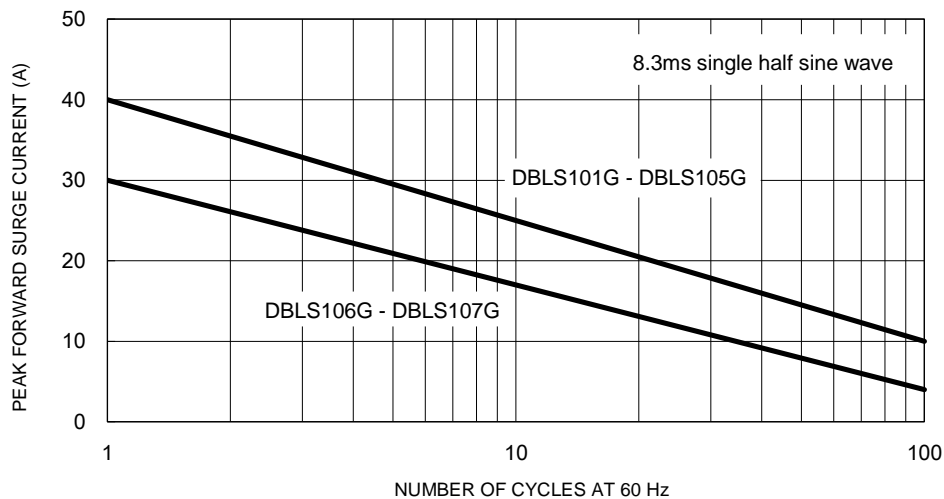

**PACKAGE OUTLINE DIMENSIONS**

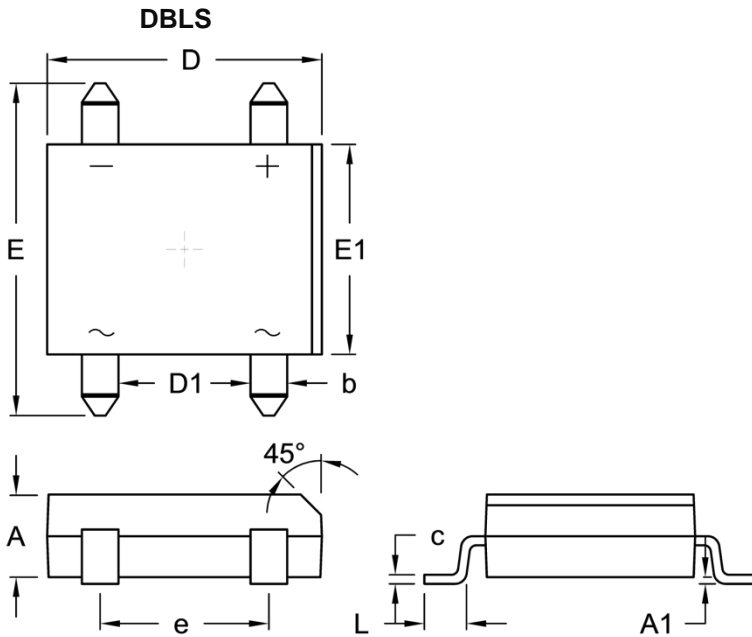

DIM.	Unit (mm)		Unit (inch)	
	Min.	Max.	Min.	Max.
A	2.40	2.60	0.094	0.102
A1	0.076	0.330	0.003	0.013
b	1.02	1.20	0.040	0.047
c	0.22	0.33	0.009	0.013
D	8.13	8.51	0.320	0.335
D1	3.90	4.10	0.154	0.161
E	9.80	10.30	0.386	0.406
E1	6.20	6.50	0.244	0.256
e	5.00	5.20	0.197	0.205
L	1.02	1.53	0.040	0.060

**SUGGESTED PAD LAYOUT**

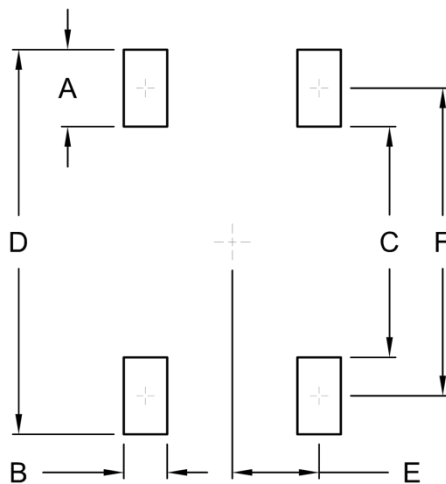

Symbol	Unit (mm)	Unit (inch)
A	2.30	0.091
B	1.30	0.051
C	6.90	0.272
D	11.50	0.453
E	2.60	0.102
F	9.20	0.362

**MARKING DIAGRAM**



- P/N = Marking Code
- G = Green Compound
- YW = Date Code
- F = Factory Code