

2A, 50V - 1400V Standard Bridge Rectifier

FEATURES

- AEC-Q101 qualified available
- Ideal for printed circuit board
- Reliable low cost construction utilizing molded plastic technique
- High surge current capability
- UL Recognized File # E-326854
- Moisture sensitivity level: level 1, per J-STD-020
- RoHS Compliant
- Halogen-free according to IEC 61249-2-21

APPLICATIONS

- Switching mode power supply (SMPS)
- Adapters
- Lighting application

MECHANICAL DATA

- Case: DBLS
- Molding compound meets UL 94V-0 flammability rating
- Terminal: Matte tin plated leads, solderable per J-STD-002
- Meet JESD 201 class 2 whisker test
- Polarity: As marked
- Weight: 0.360g (approximately)

KEY PARAMETERS		
PARAMETER	VALUE	UNIT
I_F	2	A
V_{RRM}	50 - 1400	V
I_{FSM}	50	A
$T_{J\ MAX}$	150	°C
Package	DBLS	
Configuration	Quad	

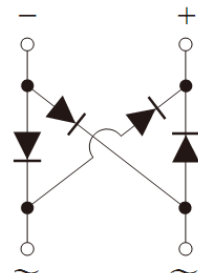
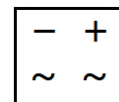
DBLS

ABSOLUTE MAXIMUM RATINGS ($T_A = 25^\circ\text{C}$ unless otherwise noted)											
PARAMETER	SYMBOL	DBLS 201G	DBLS 202G	DBLS 203G	DBLS 204G	DBLS 205G	DBLS 206G	DBLS 207G	DBLS 208G	DBLS 209G	UNIT
Marking code on the device		DBLS 201G	DBLS 202G	DBLS 203G	DBLS 204G	DBLS 205G	DBLS 206G	DBLS 207G	DBLS 208G	DBLS 209G	
Repetitive peak reverse voltage	V_{RRM}	50	100	200	400	600	800	1000	1200	1400	V
Reverse voltage, total rms value	$V_{R(RMS)}$	35	70	140	280	420	560	700	840	980	V
Forward current	I_F	2									A
Peak forward surge current, 8.3ms single half sine-wave superimposed on rated load	I_{FSM}	50									A
Rating for fusing ($t < 8.3\text{ms}$)	I^2t	10.3									A^2s
Junction temperature	T_J	- 55 to +150									°C
Storage temperature	T_{STG}	- 55 to +150									°C

THERMAL PERFORMANCE			
PARAMETER	SYMBOL	TYP	UNIT
Junction-to-lead thermal resistance	$R_{\theta JL}$	15	°C/W
Junction-to-ambient thermal resistance	$R_{\theta JA}$	40	°C/W

ELECTRICAL SPECIFICATIONS ($T_A = 25^\circ\text{C}$ unless otherwise noted)						
PARAMETER		CONDITIONS	SYMBOL	TYP	MAX	UNIT
Forward voltage per diode ⁽¹⁾	DBLS201G	$I_F = 2\text{A}, T_J = 25^\circ\text{C}$	V_F	-	1.15	V
	DBLS202G					
	DBLS203G					
	DBLS204G					
	DBLS205G					
	DBLS206G					
	DBLS207G					
	DBLS208G			-	1.30	V
Reverse current @ rated V_R per diode ⁽²⁾		$T_J = 25^\circ\text{C}$	I_R	-	2	μA
		$T_J = 125^\circ\text{C}$		-	500	μA

Notes:

1. Pulse test with $PW = 0.3\text{ms}$
2. Pulse test with $PW = 30\text{ms}$

ORDERING INFORMATION		
ORDERING CODE ⁽¹⁾⁽²⁾	PACKAGE	PACKING
DBLS2xG	DBLS	1,500 / Tape & Reel
DBLS2xGH	DBLS	1,500 / Tape & Reel

Notes:

1. "x" defines voltage from 50V(DBLS201G) to 1400V(DBLS209G)
2. "H" means AEC-Q101 qualified

CHARACTERISTICS CURVES

($T_A = 25^\circ\text{C}$ unless otherwise noted)

Fig.1 Forward Current Derating Curve

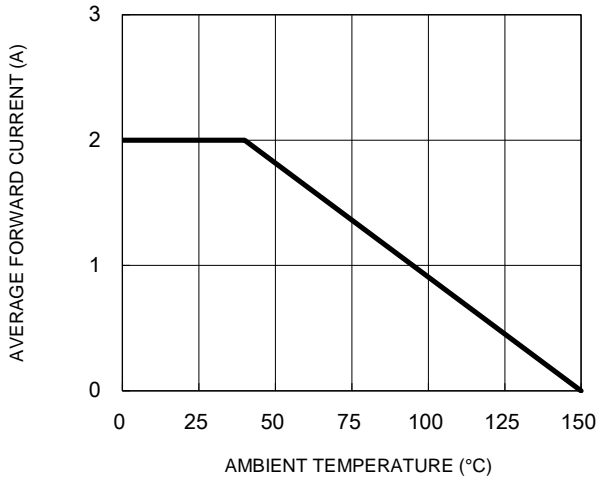

Fig.2 Typical Junction Capacitance

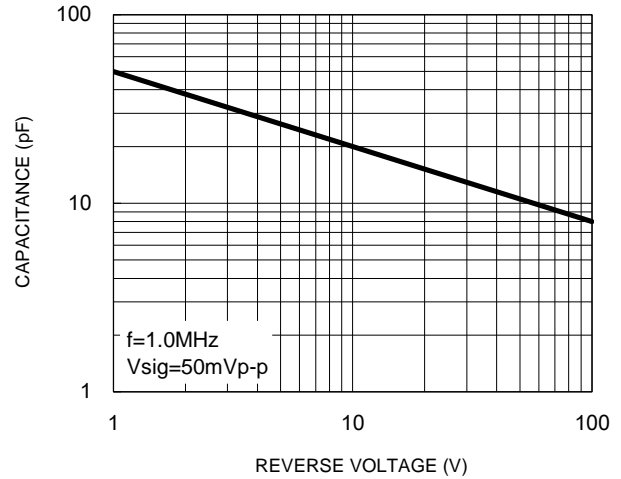

Fig.3 Typical Reverse Characteristics

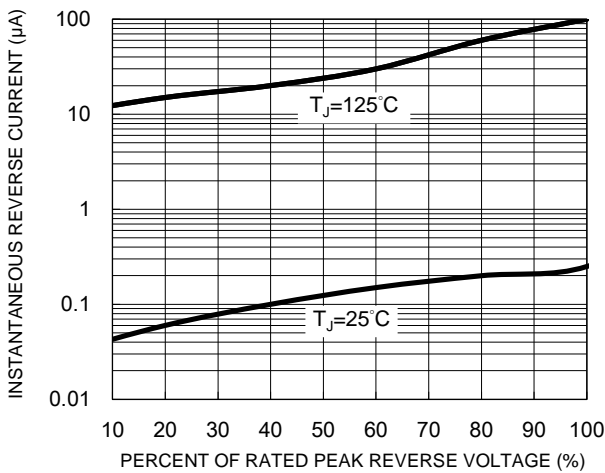

Fig.4 Typical Forward Characteristics

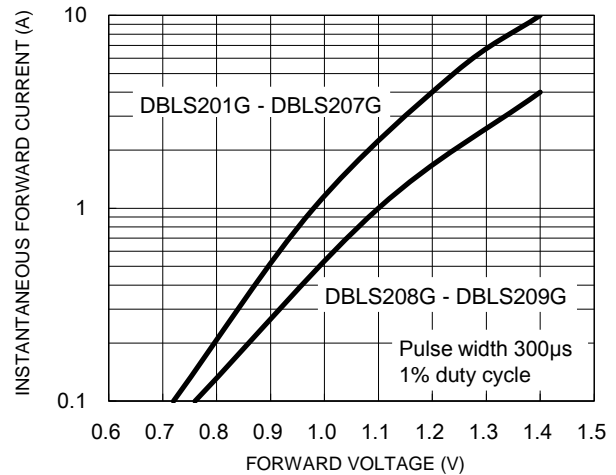
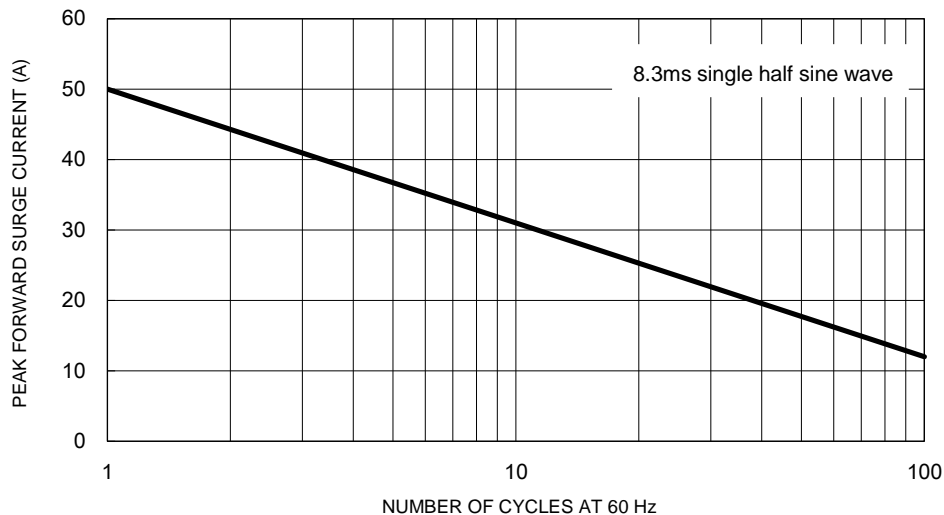
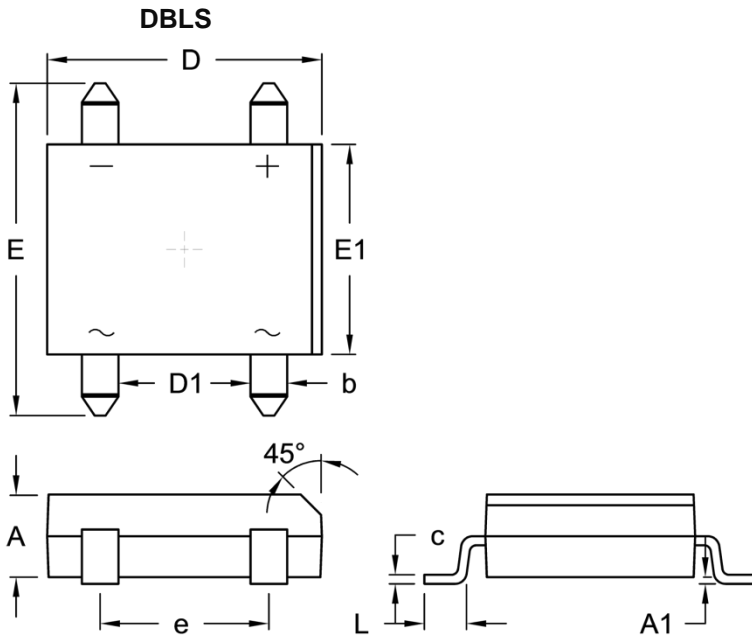

Fig.5 Maximum Non-Repetitive Forward Surge Current



PACKAGE OUTLINE DIMENSIONS



DIM.	Unit (mm)		Unit (inch)	
	Min.	Max.	Min.	Max.
A	2.40	2.60	0.094	0.102
A1	0.076	0.330	0.003	0.013
b	1.02	1.20	0.040	0.047
c	0.22	0.33	0.009	0.013
D	8.13	8.51	0.320	0.335
D1	3.90	4.10	0.154	0.161
E	9.80	10.30	0.386	0.406
E1	6.20	6.50	0.244	0.256
e	5.00	5.20	0.197	0.205
L	1.02	1.53	0.040	0.060

SUGGESTED PAD LAYOUT

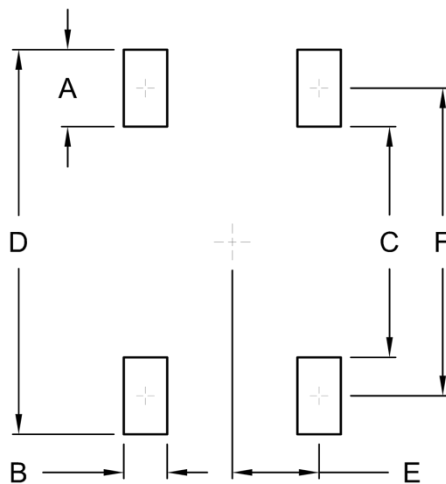

Symbol	Unit (mm)	Unit (inch)
A	2.30	0.091
B	1.30	0.051
C	6.90	0.272
D	11.50	0.453
E	2.60	0.102
F	9.20	0.362

MARKING DIAGRAM



- P/N = Marking Code
- G = Green Compound
- YW = Date Code
- F = Factory Code