

Directional Couplers

DBTC-16-5-75+ DBTC-16-5-75L+

75Ω, 16dB coupling, 5 to 1500 MHz



Generic photo used for illustration purposes only

No Leads

Leads

CASE STYLE:AT790-1

CASE STYLE:AT1030

+RoHS Compliant

The +Suffix identifies RoHS Compliance. See our web site for RoHS Compliance methodologies and qualifications

Available Tape and Reel at no extra cost	
Reel Size	Devices/Reel
7"	20, 50, 100, 200, 500
13"	1000, 2000

Maximum Ratings

Operating Temperature	-40°C to 85°C
Storage Temperature	-55°C to 100°C

Permanent damage may occur if any of these limits are exceeded.

Pin Connections

INPUT	3
OUTPUT	4
COUPLED	1
GROUND	2
ISOLATE (DO NOT USE)	6

Features

- very flat coupling
- very broadband, multi octave
- temperature stable, LTCC base
- all welded construction
- leads attached for better solderability
- micro miniature coupler
- aqueous washable
- protected by US Patents 6,140,887 & 6,784,521

Applications

- VHF/UHF receivers/transmitters
- cellular

Electrical Specifications

FREQ. RANGE (MHz)	COUPLING (dB)		MAINLINE LOSS* (dB)				DIRECTIVITY (dB)				VSWR** (:1)	POWER INPUT (W)					
	Nom.	Flatness	L	M	U	L	M	U	Typ.	Min.		Typ.	Min.	L	MU		
5-1000	16.3±0.5	±0.7	1.2	2.0	1.0	1.5	1.1	1.6	22	16	21	13	20	—	1.3	0.5	1.0
1000-1500	16.8±0.7	±0.7	—	—	1.3	1.9	—	—	—	—	19	—	—	—	1.3	—	1.0

L = 5-50 MHz, M=50-500 MHz, U=500-1000 MHz apply to upper row of specs. 2nd row is for 1000-1500 MHz.

* Includes theoretical coupled power loss of 0.10 dB at 16 dB coupling

** For coupled port VSWR above 500 MHz, 1.6:1 typ.

Outline Drawing / Dimensions (inch mm)

AT790-1 (DBTC-16-5-75)

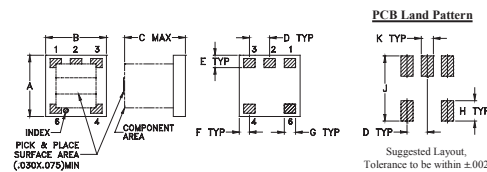

A	B	C	D	E	F	G	H	J	K	wt
.150	.150	.150	.050	.030	.025	.028	.050	.160	.030	grams
3.81	3.81	3.81	1.27	0.76	0.64	0.71	1.27	4.06	0.76	0.10

AT1030 (DBTC-16-5-75L)

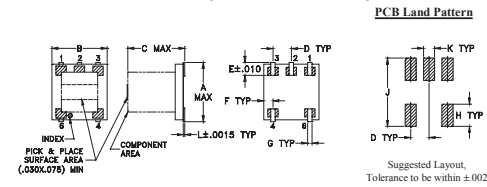

A	B	C	D	E	F	G	H	J	K	L	wt
.166	.150	.155	.050	.037	.025	.012	.060	.184	.030	.004	grams
4.22	3.81	3.94	1.27	0.94	0.64	0.30	1.52	4.67	0.76	0.10	0.10

Demo Board MCL P/N: TB-279 Suggested PCB Layout (PL-151)

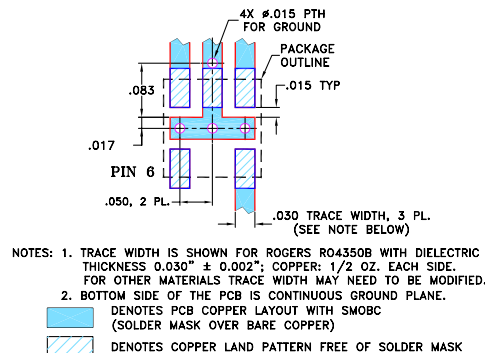

Notes

- Performance and quality attributes and conditions not expressly stated in this specification document are intended to be excluded and do not form a part of this specification document.
- Electrical specifications and performance data contained in this specification document are based on Mini-Circuit's applicable established test performance criteria and measurement instructions.
- The parts covered by this specification document are subject to Mini-Circuit's standard limited warranty and terms and conditions (collectively, "Standard Terms"); Purchasers of this part are entitled to the rights and benefits contained therein. For a full statement of the Standard Terms and the exclusive rights and remedies thereunder, please visit Mini-Circuit's website at www.minicircuits.com/WCLStore/terms.jsp

Typical Performance Data

Frequency (MHz)	Mainline Loss (dB) In-Out	Coupling (dB) In-Cpl	Directivity (dB)	Return Loss (dB)		
				In	Out	Cpl
5.0	1.32	16.54	22.53	16.26	17.94	12.74
10.0	1.18	16.25	22.81	18.13	20.48	14.84
20.0	1.13	16.14	23.00	18.94	21.68	15.90
50.0	1.13	16.11	23.19	19.20	22.11	16.31
70.0	1.13	16.10	23.23	19.30	22.19	16.37
100.0	1.12	16.10	23.35	19.41	22.38	16.43
500.0	1.08	16.18	25.13	21.01	24.62	14.81
700.0	1.07	16.27	23.81	21.95	25.41	13.38
1000.0	1.09	16.56	20.29	23.20	24.19	11.31
1500.0	1.19	17.35	16.40	22.34	20.43	8.71

DBTC-16-5-75+ MAINLINE LOSS

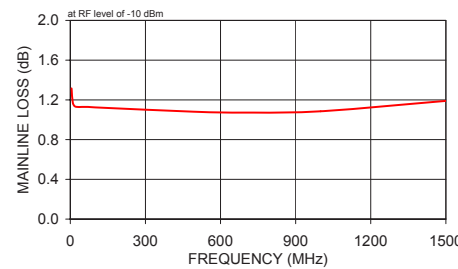

DBTC-16-5-75+ COUPLING & DIRECTIVITY

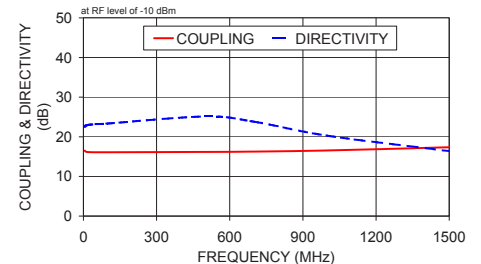

DBTC-16-5-75+ RETURN LOSS

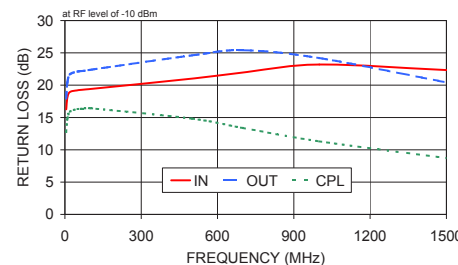

Electrical Schematic

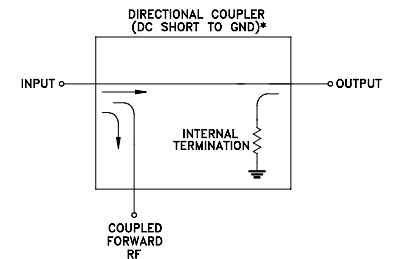

* ELECTRICAL SCHEMATIC IS FOR DIRECTIONAL COUPLER WITH INTERNAL TRANSFORMER(S) THAT ROUTES DC FROM RF PORTS TO GROUND.