

LTC1421 Hot Swap Controller Controls Three Supplies

DESCRIPTION

Demonstration circuit DC116 is a protected, triple-output Hot Swap™ controller. This circuit is designed to allow a PC board to be safely inserted into and removed from a live backplane without disturbing the system power or damaging the connector pins due to high inrush currents. A programmable electronic circuit breaker protects against shorts.

Also included on the demo board are LEDs that indicate whether the circuit breaker has tripped, a power failure has occurred or the switches are turned off. A push-button switch is provided for users to generate a system reset and cycle the outputs. Dip switches allow the trip levels of the output voltage monitoring circuitry to be changed.

The complete demo includes two separate boards, DC116A and DC116B. The DC116B is used to simulate the system backplane with three supply inputs. All the inputs are bypassed with large capacitors. The DC116A is the daughter board to be inserted into and removed from the system power bus. The LTC®1421 and all other components are placed on this board. A staggered-pin connector is used to ensure proper connection sequencing.

The applications for DC116 include any system with a data bus and multiple power supplies that needs to be inserted into or removed from a live system backplane.

LT, LTC and LT are registered trademarks of Linear Technology Corporation. Hot Swap is a trademark of Linear Technology Corporation.

BOARD PHOTOS

DC116A
 Hot Swap Controller

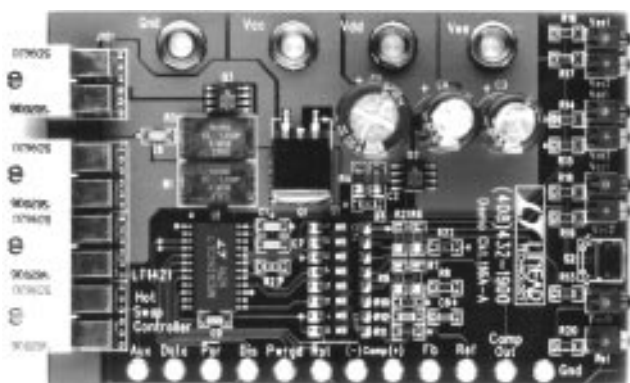

DC116A PHOTO

DC116B
 System Backplane

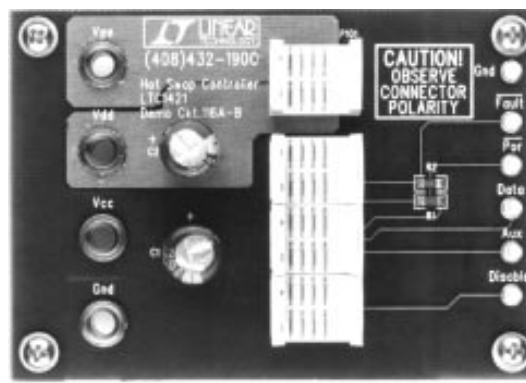

DC116B PHOTO

DEMO MANUAL DC116

HOT SWAP CONTROLLER

PERFORMANCE SUMMARY

SYMBOL	PARAMETER	CONDITIONS	VALUE
V_{CC}, V_{DD}	Input Supply Voltage	Positive Supply	3V to 12.6V
V_{EE}	Input Supply Voltage	Negative Supply	-3V to -12.6V
I_{LIM}	Maximum Output Current	V_{CC2} V_{DD2}	10A 2A

TYPICAL PERFORMANCE CHARACTERISTICS

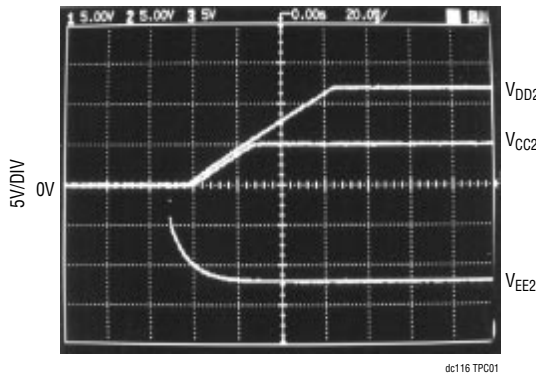

Figure 1. Live Insertion into the System Backplane

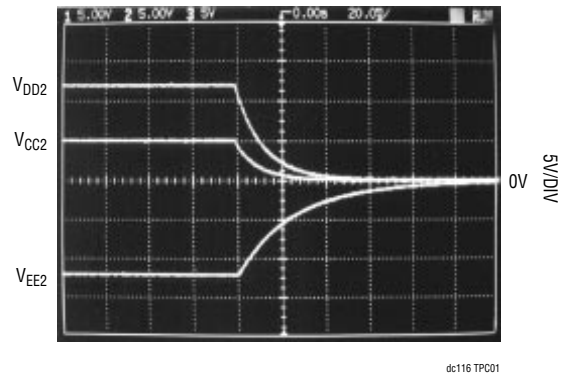
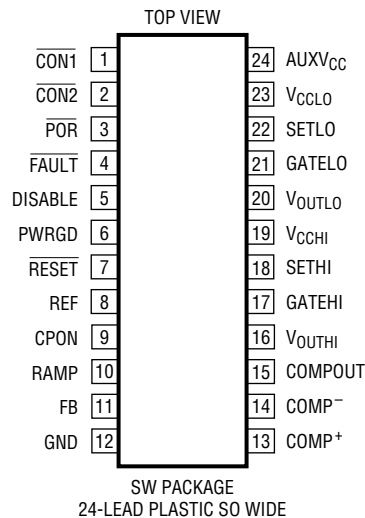

Figure 2. Live Removal from the System Backplane

PACKAGE DIAGRAM



LTC1421CSW

SCHEMATIC DIAGRAM DC116A

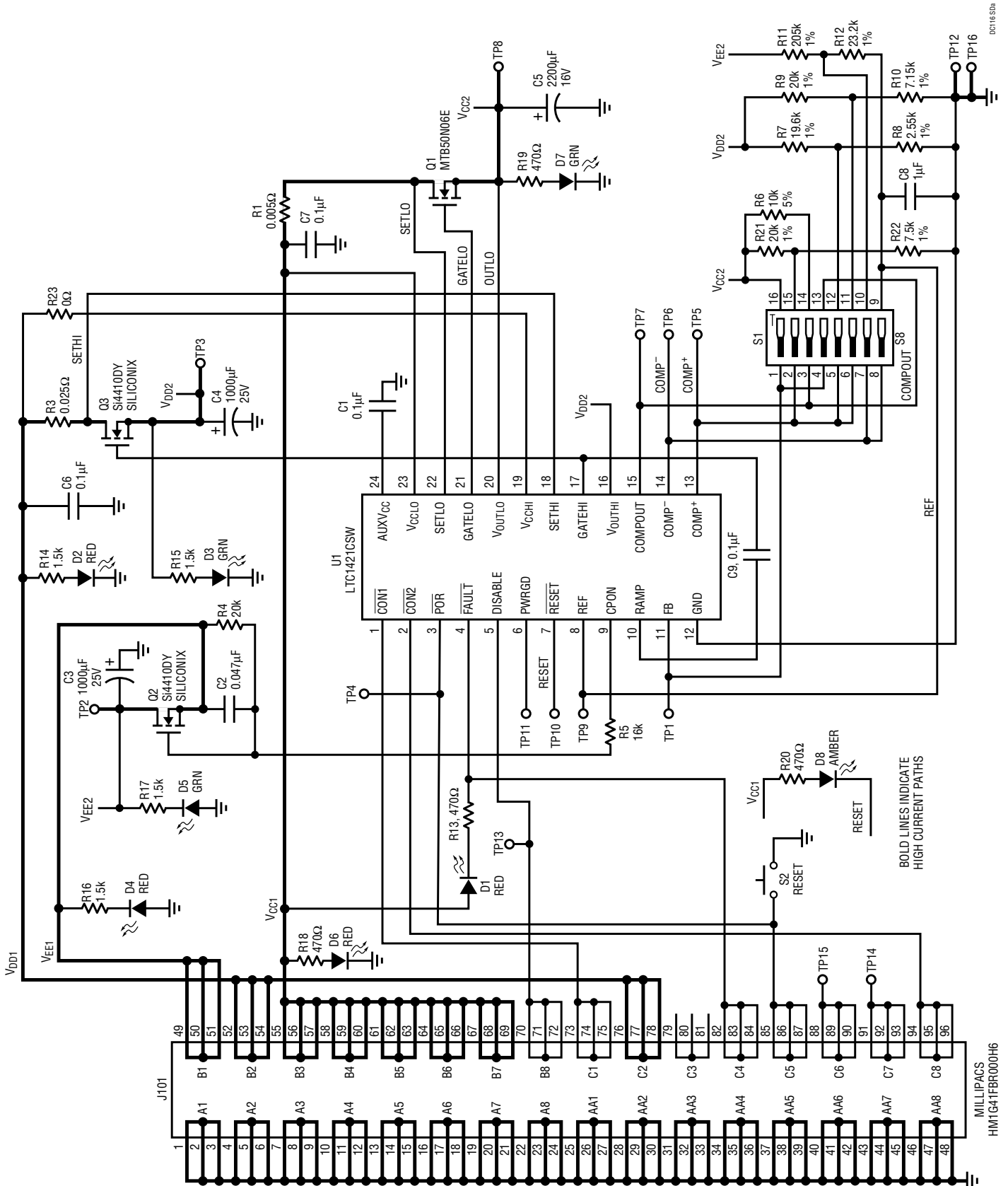

DC116SDA

DEMO MANUAL DC116

HOT SWAP CONTROLLER

SCHEMATIC DIAGRAM DC116B

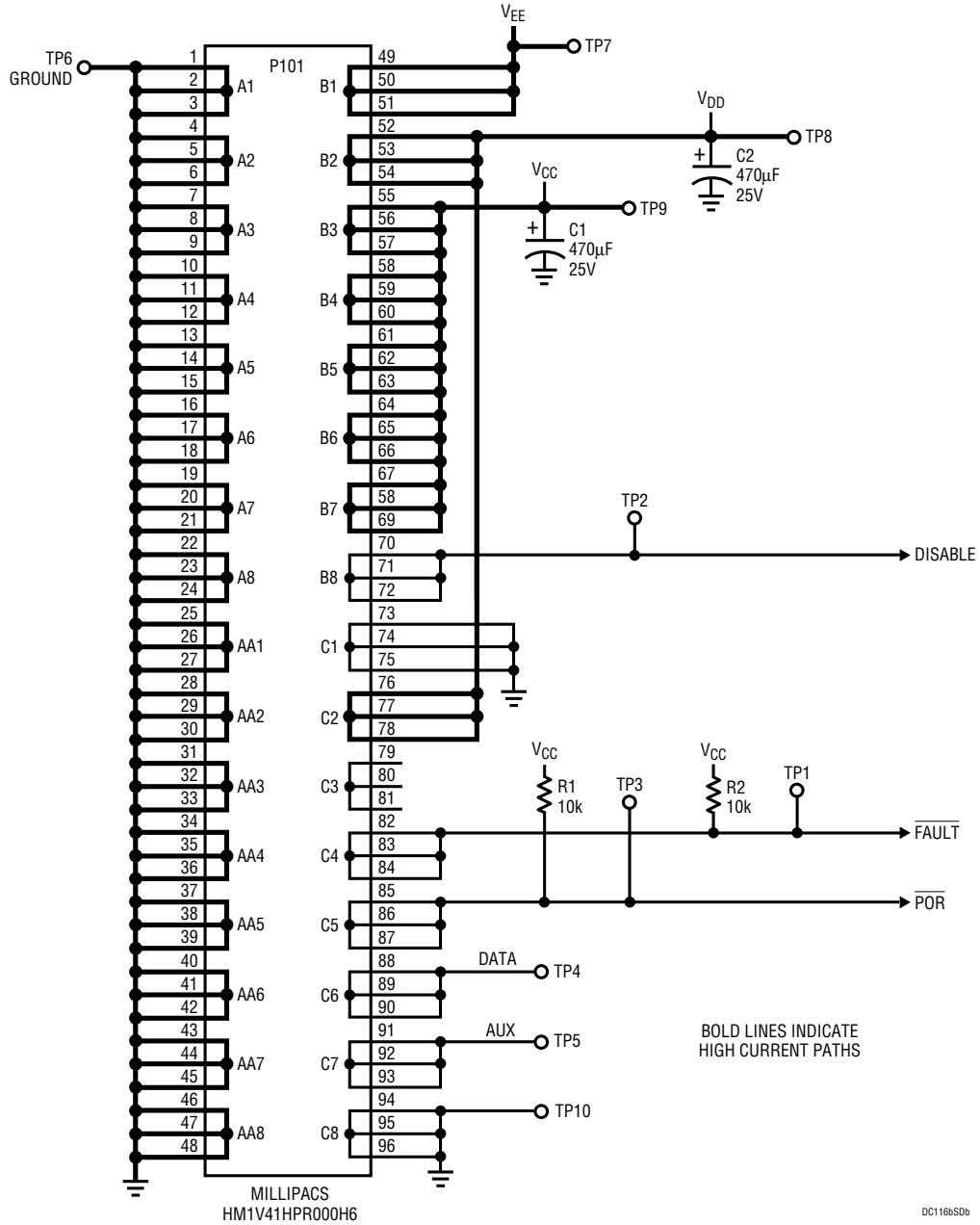

DEMO MANUAL DC116

HOT SWAP CONTROLLER

PARTS LIST DC116A

REFERENCE DESIGNATOR	QUANTITY	PART NUMBER	DESCRIPTION	VENDOR	TELEPHONE
C1, C6, C7, C9	4	12065C104KAT2	0.1 μ F 50V 10% X7R Capacitor	AVX	(803) 946-0362
C2	1	12065C473KAT2	0.047 μ F 50V 10% X7R Capacitor	AVX	(803) 946-0362
C3, C4	2	25MV102CZ	1000 μ F 25V Aluminum Capacitor	Sanyo	(619) 661-6835
C5	1	16MV222CZ	2200 μ F 16V Aluminum Capacitor	Sanyo	(619) 661-6835
C8	1	6Y5U105Z025AL	1 μ F 25V 10% Y5U Capacitor	Murata	(814) 237-1431
D1, D2, D4, D6	4	5600F1	Red LED	Chicago Miniature Lamp	(201) 489-8989
D3, D5, D7	3	5600F5	Green LED	Chicago Miniature Lamp	(201) 489-8989
D8	1	5600F7	Yellow LED	Chicago Miniature Lamp	(201) 489-8989
J101	1	HM1G41FBR000H6	Millipacs Female Connector	FCI	(717) 767-8005
Q1	1	MTB50N06E	N-Channel MOSFET, 50A, 60V	Motorola	(602) 244-3576
Q2, Q3	1	Si4410DY	N-Channel MOSFET	Siliconix	(800) 554-5565
R1	1	WSL-2010-005-1%	0.005 Ω 1/2W 1% Resistor	Dale	(605) 665-9301
R3	1	WSL-2010-025-1%	0.025 Ω 1/2W 1% Resistor	Dale	(605) 665-9301
R4	1	CR32-203J-T	20k 1/8W 5% Resistor	AVX	(803) 946-0524
R5	1	CR32-163J-T	16k 1/8W 5% Resistor	AVX	(803) 946-0524
R6	1	CR32-103J-T	10k 1/8W 5% Resistor	AVX	(803) 946-0524
R7	1	CR32-1962F-T	19.6k 1/8W 1% Resistor	AVX	(803) 946-0524
R8	1	CR32-2491F-T	2.49k 1/8W 1% Resistor	AVX	(803) 946-0524
R9, R21	2	CR32-2002F-T	20k 1/8W 1% Resistor	AVX	(803) 946-0524
R10	1	CR32-7151F-T	7.15k 1/8W 1% Resistor	AVX	(803) 946-0524
R11	1	CR32-2053F-T	205k 1/8W 1% Resistor	AVX	(803) 946-0524
R12	1	CR32-2322F-T	23.2k 1/8W 1% Resistor	AVX	(803) 946-0524
R13, R18 to R20	4	CR32-470J-T	470 Ω 1/8W 5% Resistor	AVX	(803) 946-0524
R14 to R17	4	CR32-152J-T	1.5k 1/8W 5% Resistor	AVX	(803) 946-0524
R22	1	CR32-7501F-T	7.5k 1/8W 1% Resistor	AVX	(803) 946-0524
R23	1	CJ-000T	0 Ω 1/8W 5% 1206 Resistor	AVX	(803) 946-0524
S1	1	DMR-08	Switch	APEM	(781) 246-1007
S2	1	MJTP1236	Switch	APEM	(781) 246-1007
TP1, TP4 to TP7, TP9 to TP11, TP13 to TP16	12	1502-2	Turret	Keystone	(718) 956-8900
TP2, TP3, TP8, TP12	4	575-4	Banana Jack	Keystone	(718) 956-8900
U1	1	LTC1421CSW	IC	Linear Technology	(408) 432-1900
	1	Demo Board DC116A	Printed Circuit Board		

DC116B

C1, C2	2	25MV470CZ	470 μ F 25V Elect Capacitor	Sanyo	(619) 661-6835
P101	1	HM1V41HPR000H6	Millipacs Male Connector	FCI	(717) 767-8005
R1, R2, R3	2	CR32-103J-T	10k 1/8W 5% Resistor	AVX	(803) 946-0524
TP1 to TP5, TP10	6	1502-2	Turret	Keystone	(718) 956-8900
TP6 to TP9	4	575-4	Banana Jack	Keystone	(718) 956-8900
	4		#4-40x1/4" Screw HWD	Any	
	4		#4-40x1/2" Stand-Off Nylon Hex HWD	Keystone	(718) 956-8900
	1	Demo Board DC116B	Printed Circuit Board		

QUICK START GUIDE

The demonstration board set, DC116, is easily set up for evaluation of the LTC1421 IC. Please follow the procedure outlined below for error-free operation.

- Connect the positive power supply with the lower potential to V_{CC} (TP9) and the higher one to V_{DD} (TP8) on **DC116B**. Connect the ground lead(s) to TP6. Do not exceed 12.6V for either supply to ensure proper operation of the LTC1421.
- Connect the negative power supply to V_{EE} (TP7) and GND (TP6) on **DC116B**. Do not exceed $-12.6V$ on V_{EE} .
- Connect the loads to outputs V_{CC2} (TP8), V_{DD2} (TP3) and V_{EE2} (TP2) on the **DC116A** board. Connect the return side of the lead(s) to TP12 or TP16 (GND).
- Select the proper dip switches to monitor the outputs and set the trip level for the RESET output.
- Apply power and insert the daughter board (**DC116A**) into the system backplane (**DC116B**). Rock the daughter board back and forth to ensure good connection.
- The LEDs will turn on to indicate the status of the input and output supplies as well as the circuit breaker.

OPERATION

The circuit shown in the Schematic Diagram allows three power supplies, V_{DD} , V_{CC} and V_{EE} , to be safely inserted into and removed from the backplane. V_{CC} and V_{DD} are both positive supplies, whereas V_{EE} is a negative supply. The main supply to the LTC1421 is from V_{CC} ; its voltage should be less than or equal to that of V_{DD} . The nominal voltages are 5V for V_{CC} , 12V for V_{DD} and $-12V$ for V_{EE} .

A 0.005Ω sense resistor (R1) sets the current limit to 10A at the V_{CC} output; R3 (0.025Ω) sets the current limit at V_{DD} to 2A. The LTC1421 monitors the voltage across the sense resistors. When either voltage is greater than 50mV, the internal charge pump is turned off immediately and both the gates and voltage outputs are actively pulled to ground. The circuit breaker function remains active until the push-button switch (S2) is pressed and released or the power is cycled.

The LTC1421 limits the inrush current through the N-channel pass transistor by increasing the voltage on the gate in a controlled manner. The transient surge current ($I = C_{OUT} \cdot dV_{OUT}/dt$) drawn from the main backplane power supply can then be limited to a safe value. The ramp slope is determined by a fixed internal current source ($20\mu A$) and a ramp capacitor (C9) connected between the RAMP and GATEHI pins. The voltage at GATEHI rises with

a slope equal to $20\mu A/C_{RAMP}$. The voltage at the GATELO pin is clamped one Schottky diode drop below GATEHI.

The negative supply voltage can be controlled using the CPON pin. When the board makes a connection, the N-channel pass transistor, Q2, is turned off by R4. CPON is also pulled down to V_{EE1} . When the charge pump is turned on, CPON is pulled to V_{CC1} and the gate of Q2 ramps up with a time constant determined by R4, R5 and C2. When the charge pump is turned off, CPON goes into high impedance state; the gate of Q2 is then discharged to V_{EE1} with a time constant determined by R4 and C2 and then Q2 turns off. There is no circuit breaker or current-limit feature on the negative supply.

Power N-Channel MOSFET

External N-channel pass transistors are used to route the power from the system power supply to the plug-in board. An MTB50N06E from Motorola is used for the V_{CC} output and two 8-lead, surface mounted NFETs from Siliconix (Si4410DY) are used for V_{DD} and V_{EE} . A number of similar N-channel MOSFETs, available from different manufacturers, are also well-suited for this type of application. As a general rule, select the MOSFET with the lowest $R_{DS(ON)}$ to get the smallest voltage drop across it at the maximum output load.

OPERATION

LEDs

Several LEDs are included on the demo board to indicate the status of the input and output voltages and the circuit breaker. D2, D4 and D6, when turned on, indicate that the input supplies (V_{DD1} , V_{EE1} and V_{CC1}) from the connector are ready. The green LEDs (D3, D5 and D7), when turned on, indicate that the pass transistors are on and the input supplies have been routed to the outputs. D8 is connected from the $\overline{\text{RESET}}$ pin to V_{CC1} through a 470 Ω resistor. D8 turns on immediately after the board is inserted into the system power supplies and turns off 200ms after the PWRGD pin goes high. When the red LED (D1) lights up, a general fault condition has occurred: either the circuit breaker has tripped, a power failure has occurred or the gate driver is turned off.

Dip Switches (S1 to S8)

Eight dip switches on the demo board provide users with a convenient way to configure the output voltage(s) to be monitored and the trip levels for the $\overline{\text{RESET}}$ output. Five different configurations are listed below:

1. Close S3, S5 and S8: monitor V_{DD2} at 10.8V; reset V_{CC2} at 4.65V.
2. Close S1, S3, S6 and S8: monitor V_{CC2} at 4.65V; reset V_{CC2} at 2.9V.
3. Close S4, S5 and S8: reset V_{DD2} at 10.8V; reset V_{CC2} at 4.65V.
4. Close S2, S3, S4 and S8: reset V_{CC2} at 4.5V.
5. Close S3 and S7: monitor V_{EE2} at -10.8V; reset V_{CC2} at 4.65V.

Connector

A staggered-pin connector (HM1V41HPR000H6) from FCI is used on the boards for hot swapping. The ground pins are the longest, making connection first and breaking connection last. This will prevent ESD damage on the rest of the pins when a huge ground potential difference exists between the two boards. The connect pins ($\overline{\text{CON1}}$ and $\overline{\text{CON2}}$) are shortest, and are placed on the opposite end of the connector. The LTC1421 will not start turning on the pass transistors until the whole connector is plugged in and both $\overline{\text{CON1}}$ and $\overline{\text{CON2}}$ are connected.

PCB LAYOUT AND FILM DC116A

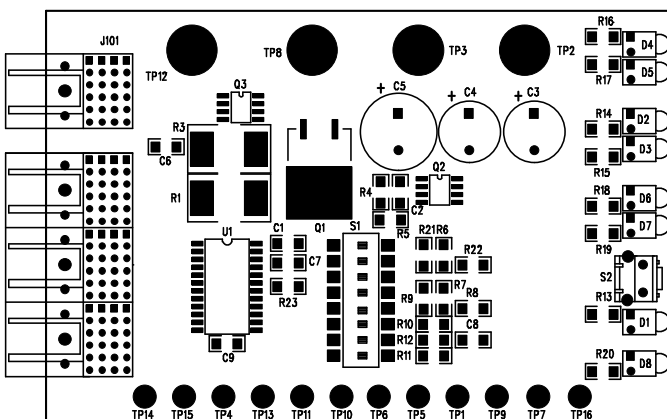

Assembly Top

DC116A ASY

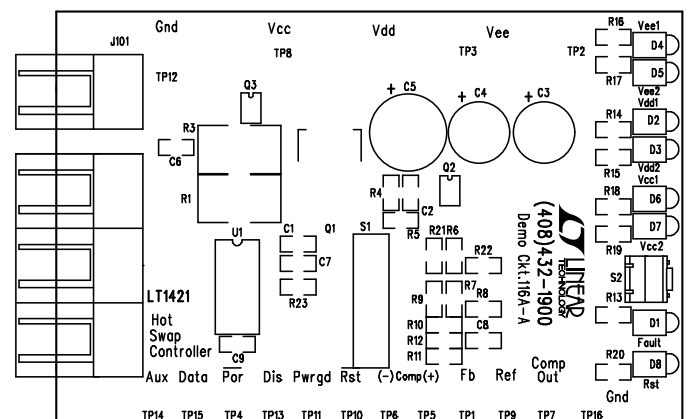

Silkscreen Top

DC116A SLK

DEMO MANUAL DC116

HOT SWAP CONTROLLER

PCB LAYOUT AND FILM DC116A

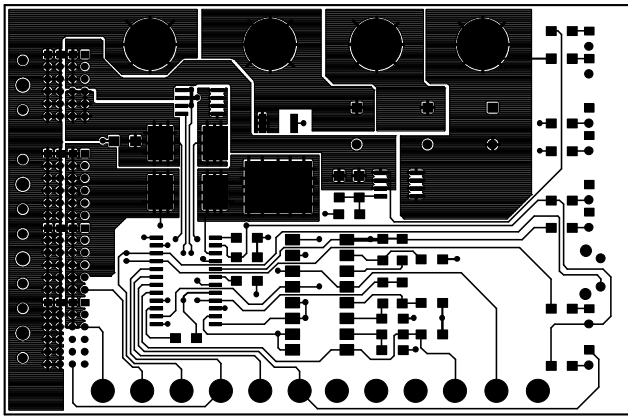

DC116A COMP

Component Side

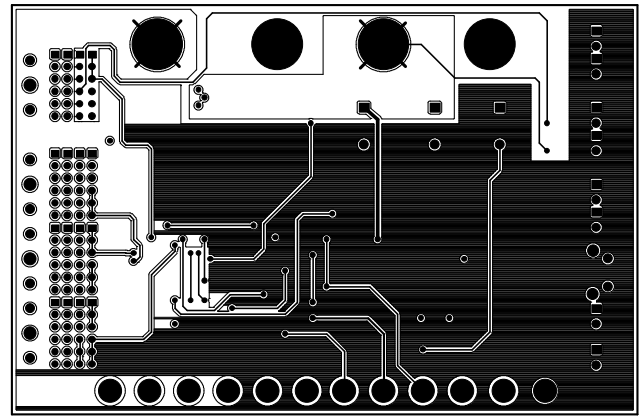

DC116A SLD

Solder Side

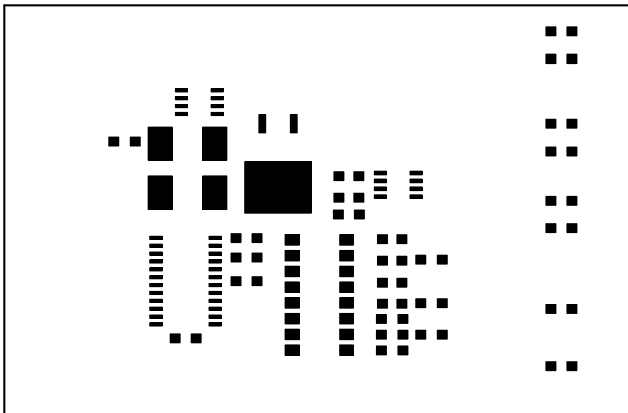

DC116A PMT

Paste Mask Top

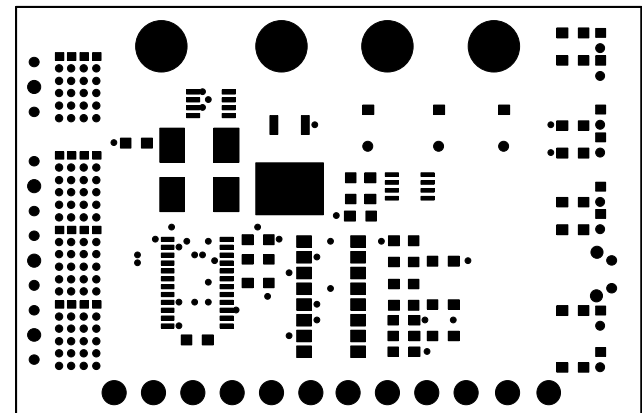

DC116A SMT

Solder Mask Top

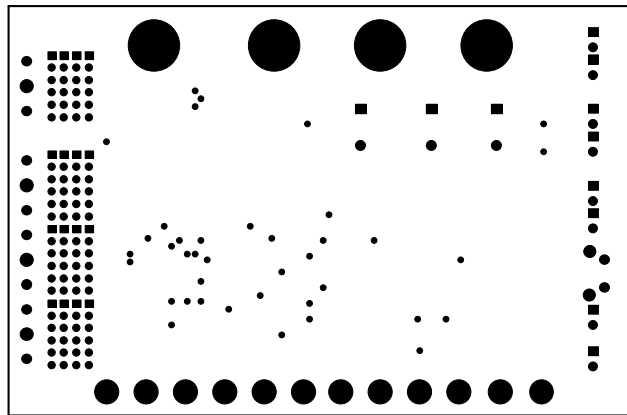

DC116A SLDB

Solder Mask Bottom

PCB LAYOUT AND FILM DC116B

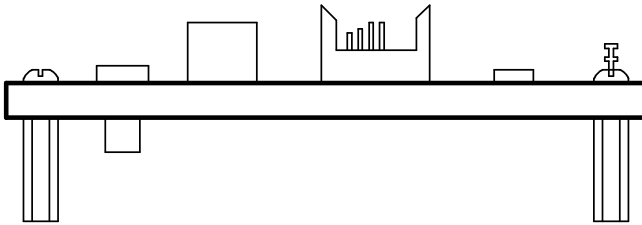
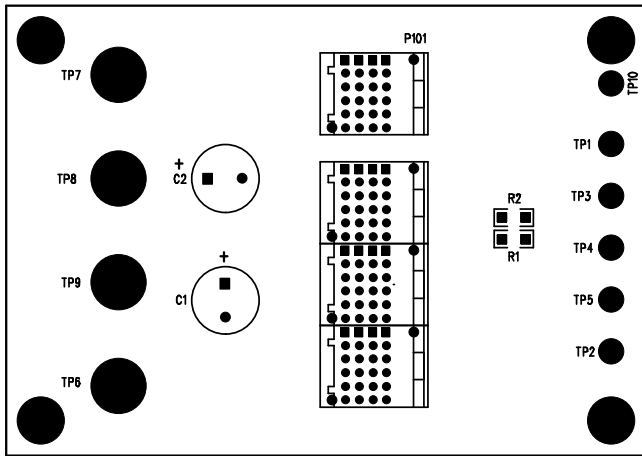

Assembly Top

DC116B ASY

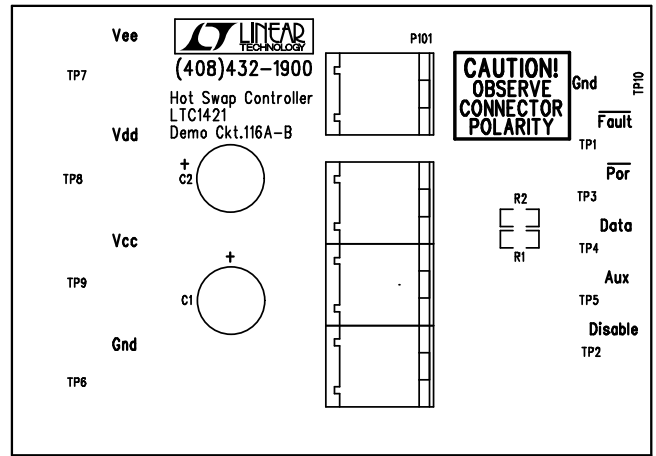

DC116B SLK

Silkscreen Top

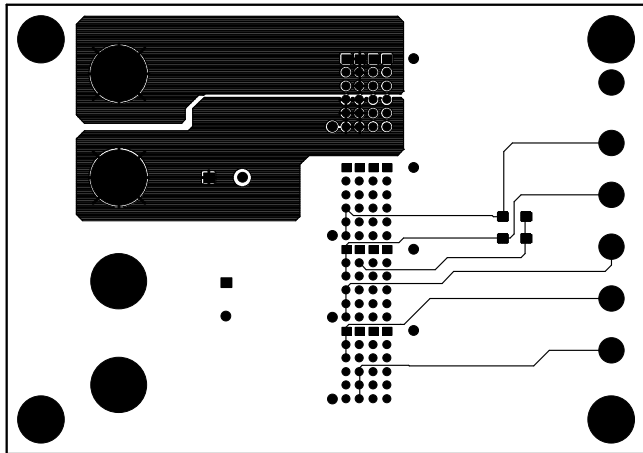

DC116B COMP

Component Side

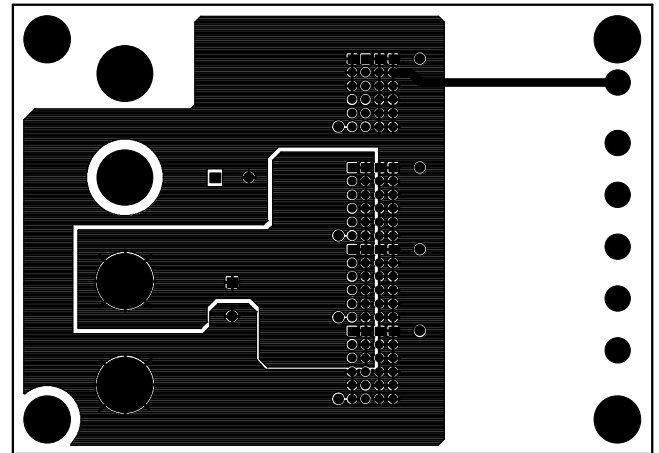

DC116B SLD

Solder Side

PCB LAYOUT AND FILM DC116B

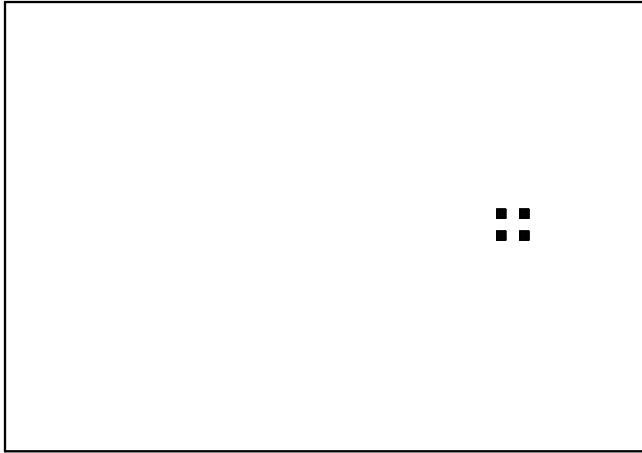

DC116B PMT

Paste Mask Top

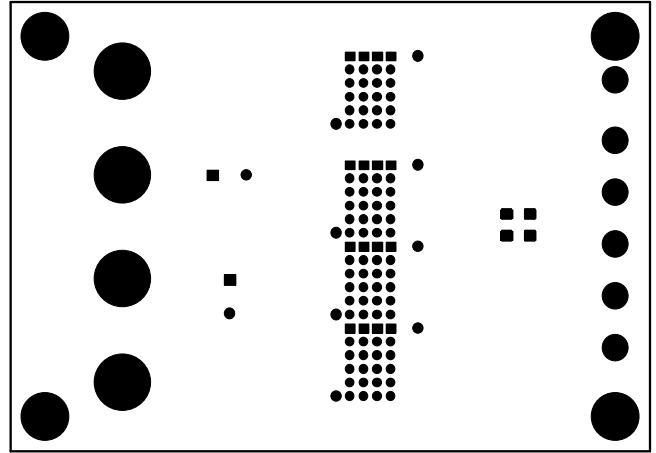

DC116B SLDT

Solder Mask Top

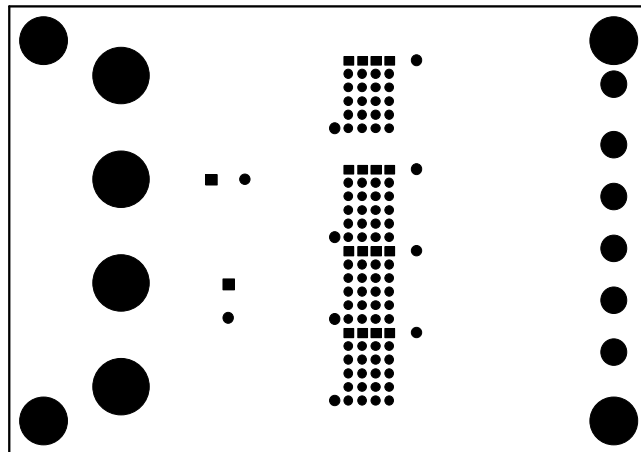

DC116B SLDB

Solder Mask Bottom

PC FAB DRAWING DC116A

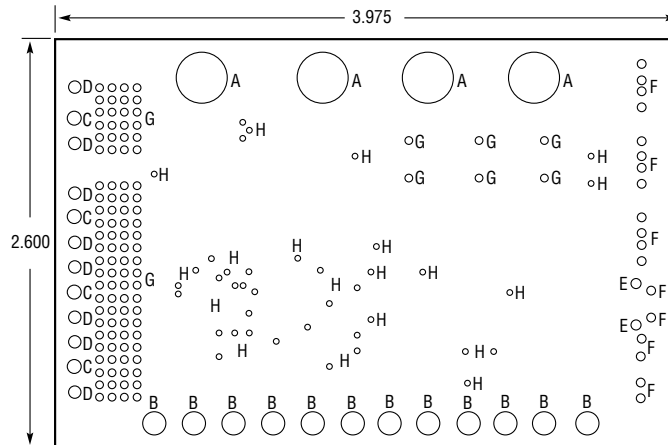

SYMBOL	DIAMETER	NUMBER	PLATED
		OF HOLES	
A	0.205	4	YES
B	0.094	12	YES
C	0.081	4	NO
D	0.060	8	NO
E	0.045	2	YES
F	0.035	18	YES
G	0.025	102	YES
H	0.015	39	YES
TOTAL HOLES		189	

NOTES: UNLESS OTHERWISE SPECIFIED

1. MATERIAL: 2 LAYERS, 0.062" THICK FR-4 GLASS EPOXY 2 OZ COPPER CLAD
2. ALL DIMENSIONS ARE IN INCHES ± 0.003
3. PLATE THRU HOLES WITH COPPER 0.0014 MIN THICKNESS.
ALL HOLE SIZES IN HOLE TABLE ARE AFTER PLATING
4. SILSCREEN: WITH WHITE EPOXY NONCONDUCTIVE INK
5. FINISH: SMOBC
6. SOLDER MASK: LPI, GREEN

DC116A FAB