

TimerBlox: Oscillators, One Shots, PWM, Delay, Power on Reset

DESCRIPTION

Demonstration circuit 1562B is an engineering tool to design and evaluate the LTC699X-X family of TimerBlox® circuits. The center section of the board contains a pre-configured TimerBlox function. DC1562B comes in twelve timing function variations as outlined in Table 1.

Surrounding the center board is a playground prototyping area. The prototyping area has pads for DIP-8, S8, MS8, or S6 packages with bread boarding connections to each pin and two convenient power buses and ground bus surrounding the entire area. This area is for conditioning signals to control the timer function and for adding loads controlled in time.

The center part of the board can be detached as a streamlined circuit, to combine with a pre-existing circuit. For application flexibility, a provision is made for buffering and inverting the output of the timer. An optional NC7W04P6X SC70 package dual inverter can be added at U2 to provide this functionality.

Design files for this circuit board are available at <http://www.linear.com/demo>

LT, LT, LTC, LTM, Linear Technology, TimerBlox and the Linear logo are registered trademarks of Linear Technology Corporation. All other trademarks are the property of their respective owners.

USING THE DEMO BOARD

To understand the simplicity and flexibility of the TimerBlox function, download the appropriate data sheet from the LTC website, www.linear.com. Each evaluation board comes with a TimerBlox part, decoupling cap and a bulk decoupling 10 μ F tantalum cap. Resistors are also installed that configure the TimerBlox device so that they are ready to use by simply adding power. Changing the default configuration of the demo board is a simple matter of determining a few new resistor values. Simply select a pair of resistor values for the DIV value from the data sheet DIV table, calculate the value of R_{SET} required, replace the resistor on the board, apply power, and go! Single supply power between 2.25V and 5.5V and ground must be supplied directly to the center board.

The outer prototyping section of the board can be used with single or dual supplies as required. **When using the prototyping area, the outermost trace, which is ground, must be connected (hand wired) to the ground on the center board section.** All input and output holes are sized for 65mil turret terminals, or wires can be soldered in the holes directly.

Changing the timer configuration requires changing resistor values on the center board. The resistor lead holes can accept “pressed-in” DIP sockets, or resistors can be soldered directly in the holes. Pads for 0805 surface mount resistors are also included at each position where a leaded resistor could be used. Pads are also included for three 25-turn trim pots which can be used to replace R_{SET} (R8) for master oscillator frequency adjustment, PSF in (R10) for voltage controlled options, and R_{DEV} (R7) for frequency divider control to permit real-time adjustments while running.

DEMO MANUAL DC1562B

USING THE DEMO BOARD

Table 1. Standard Configuration for Each Version

DEMO BOARD NUMBER	LTC PART NUMBER	PART MARKING	FUNCTION	CONFIGURED FUNCTION
DC1562B-A	LTC6990	LTDWW	HF OSC	1kHz to 10kHz Voltage Controlled Oscillator
DC1562B-B	LTC6991	LTDWY	LF OSC	1Hz (1Sec) Fixed Frequency Oscillator
DC1562B-C	LTC6992-1	LTDXB	PWM	10kHz 0% to 100% Duty Cycle PWM
DC1562B-D	LTC6992-2	LTDXD	PWM	10kHz 5% to 95% Duty Cycle PWM
DC1562B-E	LTC6992-3	LTFCQ	PWM	10kHz 0% to 95% Duty Cycle PWM
DC1562B-F	LTC6992-4	LTFCV	PWM	10kHz 5% to 100% Duty Cycle PWM
DC1562B-G	LTC6993-1	LTDXG	One-Shot	RET* 100ms Positive Output Pulse
DC1562B-H	LTC6993-2	LTDXJ	One-Shot	RET* Retriggerable 100ms Positive Output Pulse
DC1562B-I	LTC6993-3	LTFMH	One-Shot	FET** Positive 100ms Output Pulse
DC1562B-J	LTC6993-4	LTFMK	One-Shot	FET** Retriggerable 100ms Positive Output Pulse
DC1562B-K	LTC6994-1	LTFCV	Delay	Output Falling Edge Delayed 100ms from Input Falling Edge
DC1562B-L	LTC6994-2	LTFCX	Delay	Output Rise/Fall Edges Delayed 100ms from Input Rise/Fall Edges
DC1562B-M	LTC6995-1	LTGJN	POR	1sec Power on Reset
DC1562B-N	LTC6995-2	LTGJQ	POR	1sec Power on Reset

* Rising Edge Triggered

** Falling Edge Triggered

USING THE DEMO BOARD

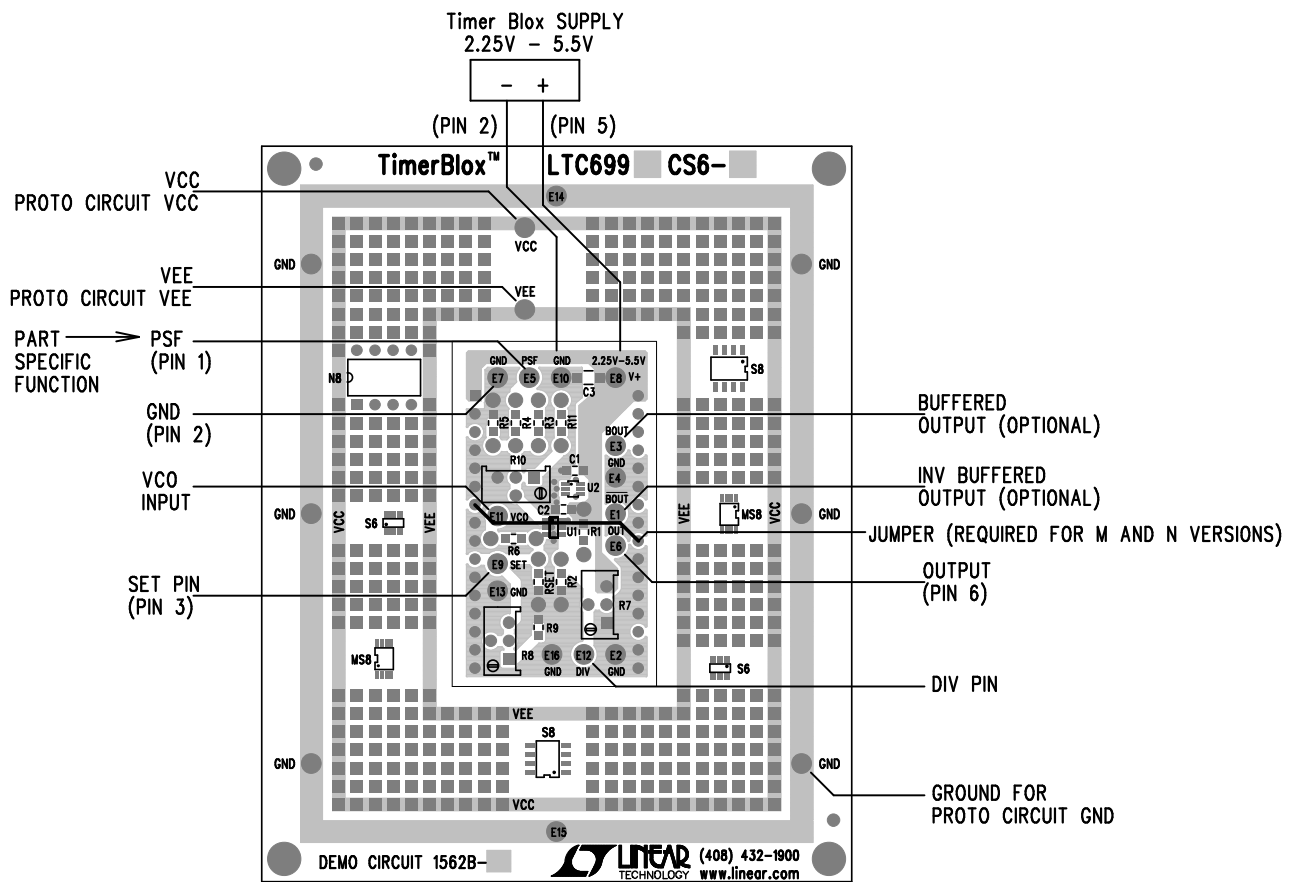

Figure 1. DC1562B-X External Connection Diagram

USING THE DEMO BOARD

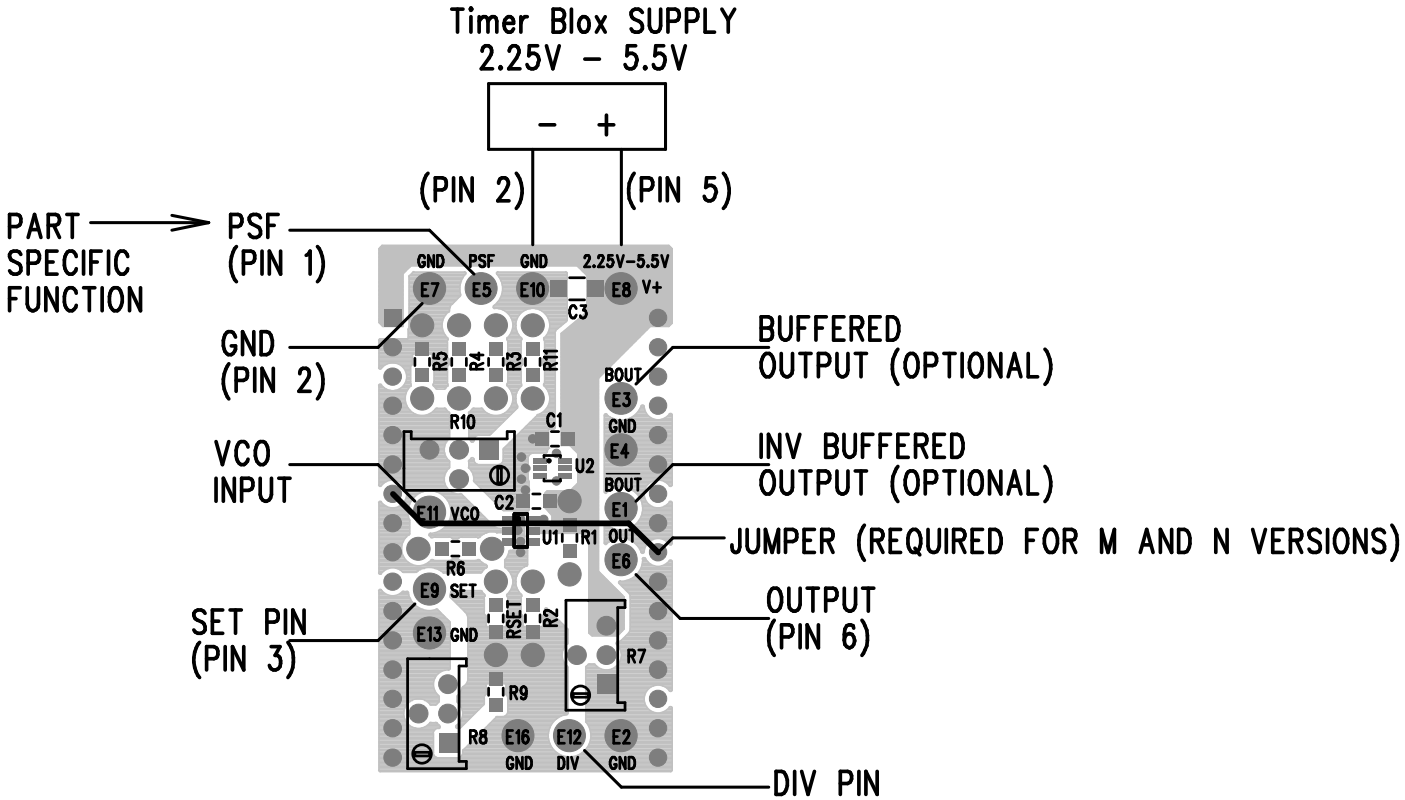

Figure 2. DC1562B-X Center Board Connection Diagram

DEFAULT CIRCUIT CONFIGURATIONS FOR EACH VERSION



Figure 3. DC1562B-A, 1kHz to 10kHz VCO



Figure 4. DC1562B-B, 1Hz (1Sec Period) Fixed Frequency Oscillator



Figure 5. DC1562B-C, 10kHz 0% to 100% Duty Cycle PWM

DEFAULT CIRCUIT CONFIGURATIONS FOR EACH VERSION



Figure 6. DC1562B-D, 10kHz 5% to 95% Duty Cycle PWM



Figure 7. DC1562B-E, 10kHz 0% to 95% Duty Cycle PWM



Figure 8. DC1562B-F, 10kHz 5% to 100% Duty Cycle PWM

DEFAULT CIRCUIT CONFIGURATIONS FOR EACH VERSION

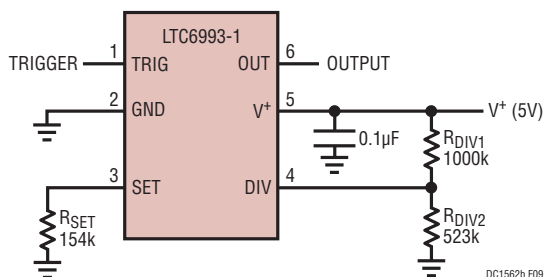

Figure 9. DC1562B-G, Rising Edge Triggered 100ms Positive Output Pulse One-Shot



Figure 10. DC1562B-H, Rising Edge Retriggered 100ms Positive Output Pulse One-Shot



Figure 11. DC1562B-I, Falling Edge Triggered 100ms Positive Output Pulse One-Shot

DEFAULT CIRCUIT CONFIGURATIONS FOR EACH VERSION



Figure 12. DC1562B-J, Falling Edge Retriggerable 100ms Positive Output Pulse One-Shot

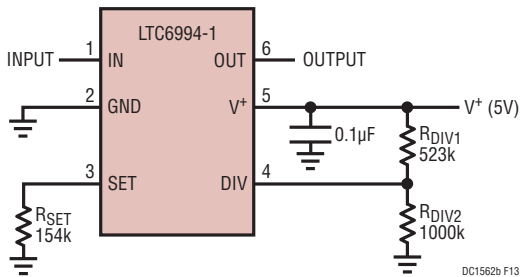

Figure 13. DC1562B-K, 100ms Delayed Output Falling Edge from Input Falling Edge

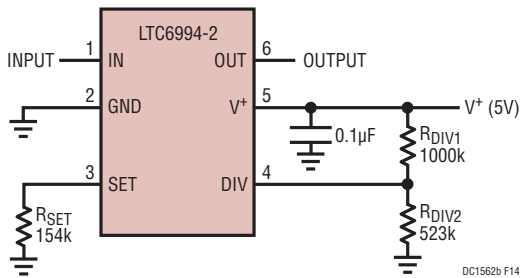

Figure 14. DC1562B-L, 100ms Delayed Output Edge from Input Edge, Both Rising and Falling Edges

DEFAULT CIRCUIT CONFIGURATIONS FOR EACH VERSION



Figure 15. DC1562B-M, 1sec Active Low Power on Reset

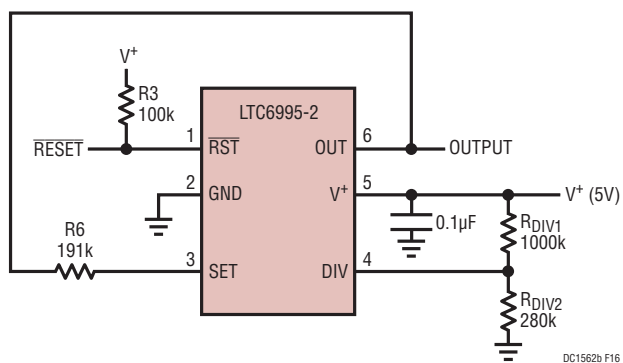

Figure 16. DC1562B-N, 1sec Active Low Power on Reset

DEMO MANUAL DC1562B

PARTS LIST

ITEM	QTY	REFERENCE	PART DESCRIPTION	MANUFACTURER/PART NUMBER
1	0	C1 (OPT.)	CAP., 0805	
2	1	C2	CAP., CHIP, X7R, 0.1µF, 25V, 0805	TDK, C2012X7R1H104K
3	1	C3	Cap., CHIP, X5R, 10µF, 16V, 1206	TAIYO YUDEN, EMK316BJ106KDT
4	24	E1-E16, E016-E18, E20-E24	TESTPOINT, TURRET, .064"	MILL-MAX, 2308-2-00-80-00-00-07-0
5	0	R9-R11 (OPT.)	RES., 0805	
6	0	R7, R8, R10 (OPT.)	POT., 3266W or 3266Y	
7	0	U2 (OPT.)	IC., NC7WZ04P6X, SC-70	
8	0	OPTIONAL SOCKETS FOR LEADED COMPONENTS		MILL MAX, 8427-0-15-01-30-02-04-0

DC1562B-A

1	1	DC1562B	GENERAL BOM	
2	1	R1	RES., CHIP, 1M, 1% 0805	VISHAY, CRCW08051M00FKEA
3	1	R2	RES., CHIP, 681k, 1% 0805	VISHAY, CRCW0805681KFKEA
4	1	R3	RES., CHIP, 100k, 1% 0805	VISHAY, CRCW0805100KFKEA
5	1	R4	RES., CHIP, 0Ω, 1% 0805	VISHAY, CRCW08050000Z0EA
6	0	R5 (OPEN)	RES., 0805	
7	1	R6	RES., CHIP, 432k, 1% 0805	VISHAY, CRCW0805432KFKEA
8	1	RSET	RES., CHIP, 95.3k, 1% 0805	VISHAY, CRCW080595K3FKEA
9	1	U1	IC., TimerBlox FAMILY, SOT-23	LINEAR TECH., LTC6990CS6

DC1562B-B

1	1	DC1562B	GENERAL BOM	
2	1	R1	RES., CHIP, 976k, 1% 0805	VISHAY, CRCW0805976KFKEA
3	1	R2	RES., CHIP, 182k, 1% 0805	VISHAY, CRCW0805182KFKEA
4	0	R3 (OPEN)	RES., 0805	
5	1	R4	RES., CHIP, 0Ω, 1% 0805	VISHAY, CRCW08050000Z0EA
6	1	R5	RES., CHIP, 100k, 1% 0805	VISHAY, CRCW0805100KFKEA
7	0	R6 (OPEN)	RES., 0805	
8	1	RSET	RES., CHIP, 768k, 1% 0805	VISHAY, CRCW0805768KFKEA
9	1	U1	IC., TimerBlox FAMILY, SOT-23	LINEAR TECH., LTC6991CS6

DC1562B-C

1	1	DC1562B	GENERAL BOM	
2	1	R1	RES., CHIP, 976k, 1% 0805	VISHAY, CRCW0805976KFKEA
3	1	R2	RES., CHIP, 182k, 1% 0805	VISHAY, CRCW0805182KFKEA
4	1	R3	RES., CHIP, 80.6k, 1% 0805	VISHAY, CRCW080580K6FKEA
5	1	R4	RES., CHIP, 10k, 1% 0805	VISHAY, CRCW080510K0FKEA
6	1	R5	RES., CHIP, 1.96k, 1% 0805	VISHAY, CRCW08051K96FKEA
7	0	R6 (OPEN)	RES., 0805	
8	1	RSET	RES., CHIP, 316k, 1% 0805	VISHAY, CRCW0805316KFKEA
9	1	U1	IC., TimerBlox FAMILY SOT-23	LINEAR TECH., LTC6992CS6-1

DC1562B-D

1	1	DC1562B	GENERAL BOM	
2	1	R1	RES., CHIP, 976k, 1% 0805	VISHAY, CRCW0805976KFKEA
3	1	R2	RES., CHIP, 182k, 1% 0805	VISHAY, CRCW0805182KFKEA
4	1	R3	RES., CHIP, 51.1k, 1% 0805	VISHAY, CRCW080551K1FKEA
5	1	R4	RES., CHIP, 10k, 1% 0805	VISHAY, CRCW080510K0FKEA
6	1	R5	RES., CHIP, 1.74k, 1% 0805	VISHAY, CRCW08051K74FKEA
7	0	R6 (OPEN)	RES., 0805	
8	1	RSET	RES., CHIP, 316k, 1% 0805	VISHAY, CRCW0805316KFKEA
9	1	U1	IC., TimerBlox FAMILY SOT-23	LINEAR TECH., LTC6992CS6-2

PARTS LIST

ITEM	QTY	REFERENCE	PART DESCRIPTION	MANUFACTURER/PART NUMBER
DC1562B-E				
1	1	DC1562B	GENERAL BOM	
2	1	R1	RES., CHIP, 976k, 1% 0805	VISHAY, CRCW0805976KFKEA
3	1	R2	RES., CHIP, 182k, 1% 0805	VISHAY, CRCW0805182KFKEA
4	1	R3	RES., CHIP, 76.8k, 1% 0805	VISHAY, CRCW080576K8FKEA
5	1	R4	RES., CHIP, 10k, 1% 0805	VISHAY, CRCW080510K0FKEA
6	1	R5	RES., CHIP, 1.82k, 1% 0805	VISHAY, CRCW08051K82FKEA
7	0	R6 (OPEN)	RES., 0805	
8	1	RSET	RES., CHIP, 316k, 1% 0805	VISHAY, CRCW0805316KFKEA
9	1	U1	IC., TimerBlox FAMILY SOT-23	LINEAR TECH., LTC6992CS6-3
DC1562B-F				
1	1	DC1562B	GENERAL BOM	
2	1	R1	RES., CHIP, 976k, 1% 0805	VISHAY, CRCW0805976KFKEA
3	1	R2	RES., CHIP, 182k, 1% 0805	VISHAY, CRCW0805182KFKEA
4	1	R3	RES., CHIP, 54.9k, 1% 0805	VISHAY, CRCW080554K9FKEA
5	1	R4	RES., CHIP, 10k, 1% 0805	VISHAY, CRCW080510K0FKEA
6	1	R5	RES., CHIP, 1.87k, 1% 0805	VISHAY, CRCW08051K87FKEA
7	0	R6 (OPEN)	RES., 0805	
8	1	RSET	RES., CHIP, 316k, 1% 0805	VISHAY, CRCW0805316KFKEA
9	1	U1	IC., TimerBlox FAMILY SOT-23	LINEAR TECH., LTC6992CS6-4
DC1562B-G				
1	1	DC1562B	GENERAL BOM	
2	1	R1	RES., CHIP, 1M, 1% 0805	VISHAY, CRCW08051M00FKEA
3	1	R2	RES., CHIP, 523k, 1% 0805	VISHAY, CRCW0805523KFKEA
4	0	R3 (OPEN)	RES., 0805	
5	1	R4	RES., CHIP, 0 Ω , 1% 0805	VISHAY, CRCW08050000Z0EA
6	1	R5	RES., CHIP, 100k, 1% 0805	VISHAY, CRCW0805100KFKEA
7	0	R6 (OPEN)	RES., 0805	
8	1	RSET	RES., CHIP, 154k, 1% 0805	VISHAY, CRCW0805154KFKEA
9	1	U1	IC., TimerBlox FAMILY, SOT-23	LINEAR TECH., LTC6993CS6-1
DC1562B-H				
1	1	DC1562B	GENERAL BOM	
2	1	R1	RES., CHIP, 1M, 1% 0805	VISHAY, CRCW08051M00FKEA
3	1	R2	RES., CHIP, 523k, 1% 0805	VISHAY, CRCW0805523KFKEA
4	0	R3 (OPEN)	RES., 0805	
5	1	R4	RES., CHIP, 0 Ω , 1% 0805	VISHAY, CRCW08050000Z0EA
6	1	R5	RES., CHIP, 100k, 1% 0805	VISHAY, CRCW0805100KFKEA
7	0	R6 (OPEN)	RES., 0805	
8	1	RSET	RES., CHIP, 154k, 1% 0805	VISHAY, CRCW0805154KFKEA
9	1	U1	IC., TimerBlox FAMILY SOT-23	LINEAR TECH., LTC6993CS6-2
DC1562B-I				
1	1	DC1562B	GENERAL BOM	
2	1	R1	RES., CHIP, 1M, 1% 0805	VISHAY, CRCW08051M00FKEA
3	1	R2	RES., CHIP, 523k, 1% 0805	VISHAY, CRCW0805523KFKEA
4	0	R3 (OPEN)	RES., 0805	
5	1	R4	RES., CHIP, 0 Ω , 1% 0805	VISHAY, CRCW08050000Z0EA
6	1	R5	RES., CHIP, 100k, 1% 0805	VISHAY, CRCW0805100KFKEA
7	0	R6 (OPEN)	RES., 0805	
8	1	RSET	RES., CHIP, 154k, 1% 0805	VISHAY, CRCW0805154KFKEA
9	1	U1	IC., TimerBlox FAMILY SOT-23	LINEAR TECH., LTC6993CS6-3

DEMO MANUAL DC1562B

PARTS LIST

ITEM	QTY	REFERENCE	PART DESCRIPTION	MANUFACTURER/PART NUMBER
DC1562B-J				
1	1	DC1562B	GENERAL BOM	
2	1	R1	RES., CHIP, 1M, 1% 0805	VISHAY, CRCW08051M00FKEA
3	1	R2	RES., CHIP, 523k, 1% 0805	VISHAY, CRCW0805523KFKEA
4	0	R3 (OPEN)	RES., 0805	
5	1	R4	RES., CHIP, 0 Ω , 1% 0805	VISHAY, CRCW08050000Z0EA
6	1	R5	RES., CHIP, 100k, 1% 0805	VISHAY, CRCW0805100KFKEA
7	0	R6 (OPEN)	RES., 0805	
8	1	RSET	RES., CHIP, 154k, 1% 0805	VISHAY, CRCW0805154KFKEA
9	1	U1	IC., TimerBlox FAMILY SOT-23	LINEAR TECH., LTC6993CS6-4
DC1562B-K				
1	1	DC1562B	GENERAL BOM	
3	1	R1	RES., CHIP, 523k, 1% 0805	VISHAY, CRCW0805523KFKEA
2	1	R2	RES., CHIP, 1M, 1% 0805	VISHAY, CRCW08051M00FKEA
4	0	R3 (OPEN)	RES., 0805	
5	1	R4	RES., CHIP, 0 Ω , 1% 0805	VISHAY, CRCW08050000Z0EA
6	1	R5	RES., CHIP, 100k, 1% 0805	VISHAY, CRCW0805100KFKEA
7	0	R6 (OPEN)	RES., 0805	
8	1	RSET	RES., CHIP, 154K, 1% 0805	VISHAY, CRCW0805154KFKEA
9	1	U1	IC., TimerBlox FAMILY SOT-23	LINEAR TECH., LTC6994CS6-1
DC1562B-L				
1	1	DC1562B	GENERAL BOM	
2	1	R1	RES., CHIP, 1M, 1% 0805	VISHAY, CRCW08051M00FKEA
3	1	R2	RES., CHIP, 523k, 1% 0805	VISHAY, CRCW0805523KFKEA
4	0	R3 (OPEN)	RES., 0805	
5	1	R4	RES., CHIP, 0 Ω , 1% 0805	VISHAY, CRCW08050000Z0EA
6	1	R5	RES., CHIP, 100k, 1% 0805	VISHAY, CRCW0805100KFKEA
7	0	R6 (OPEN)	RES., 0805	
8	1	RSET	RES., CHIP, 154k, 1% 0805	VISHAY, CRCW0805154KFKEA
9	1	U1	IC., TimerBlox FAMILY SOT-23	LINEAR TECH., LTC6994CS6-2
DC1562B-M				
1	1	DC1562B	GENERAL BOM	
2	1	R1	RES., CHIP, 1M, 1% 0805	VISHAY, CRCW08051M00FKEA
3	1	R2	RES., CHIP, 280k, 1% 0805	
4	0	R3 (OPEN)	RES., 0805	
5	1	R4	RES., CHIP, 0 Ω , 1% 0805	VISHAY, CRCW08050000Z0EA
6	1	R5	RES., CHIP, 100k, 1% 0805	VISHAY, CRCW0805100KFKEA
7	1	R6	RES., CHIP, 191k, 1% 0805	
8	0	RSET (OPEN)	RES., 0805	
9	1	U1	IC., TimerBlox FAMILY SOT-23	LINEAR TECH., LTC6995CS6-1
DC1562B-N				
1	1	DC1562B	GENERAL BOM	
2	1	R1	RES., CHIP, 1M, 1% 0805	VISHAY, CRCW08051M00FKEA
3	1	R2	RES., CHIP, 280k, 1% 0805	
4	0	R3	RES., CHIP, 100k, 1% 0805	
5	1	R4	RES., CHIP, 0 Ω , 1% 0805	VISHAY, CRCW08050000Z0EA
6	1	R5 (OPEN)	RES., 0805	
7	0	R6	RES., CHIP, 191k, 1% 0805	
8	0	RSET	RES., 0805	
9	1	U1	IC., TimerBlox FAMILY SOT-23	LINEAR TECH., LTC6995CS6-2

SCHEMATIC DIAGRAM

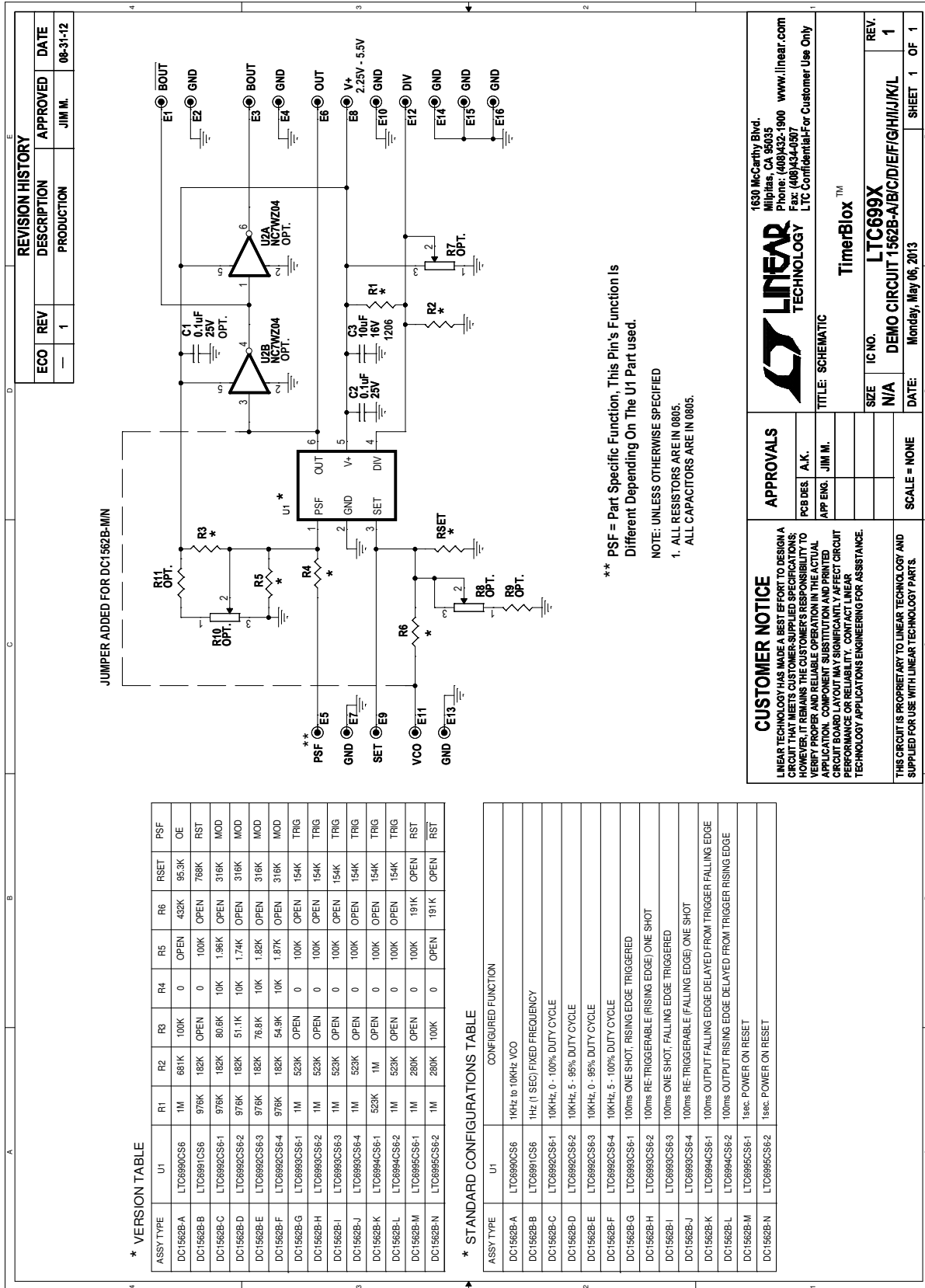

JUMPER ADDED FOR DC1562B-MIN

*** VERSION TABLE**

ASSY TYPE	U1	R1	R2	R3	R4	R5	R6	RSET	PSF
DC1562B-A	LT06990CS6	1M	681K	100K	0	OPEN	432K	95.3K	OE
DC1562B-B	LT06991CS6	976K	182K	OPEN	0	100K	OPEN	768K	RST
DC1562B-C	LT06992CS6-1	976K	182K	80.6K	10K	1.98K	OPEN	918K	MOD
DC1562B-D	LT06992CS6-2	976K	182K	51.1K	10K	1.74K	OPEN	316K	MOD
DC1562B-E	LT06992CS6-3	976K	182K	76.8K	10K	1.82K	OPEN	316K	MOD
DC1562B-F	LT06992CS6-4	976K	182K	54.9K	10K	1.87K	OPEN	316K	MOD
DC1562B-G	LT06993CS6-1	1M	523K	OPEN	0	100K	OPEN	154K	TRIG
DC1562B-H	LT06993CS6-2	1M	523K	OPEN	0	100K	OPEN	154K	TRIG
DC1562B-I	LT06993CS6-3	1M	523K	OPEN	0	100K	OPEN	154K	TRIG
DC1562B-J	LT06993CS6-4	1M	523K	OPEN	0	100K	OPEN	154K	TRIG
DC1562B-K	LT06994CS6-1	523K	1M	OPEN	0	100K	OPEN	154K	TRIG
DC1562B-L	LT06994CS6-2	1M	523K	OPEN	0	100K	OPEN	154K	TRIG
DC1562B-M	LT06995CS6-1	1M	280K	OPEN	0	100K	191K	OPEN	RST
DC1562B-N	LT06995CS6-2	1M	280K	100K	0	OPEN	191K	OPEN	RST

*** STANDARD CONFIGURATIONS TABLE**

ASSY TYPE	U1	CONFIGURED FUNCTION
DC1562B-A	LT06990CS6	1kHz to 10kHz VCO
DC1562B-B	LT06991CS6	1Hz (1 SEC) FIXED FREQUENCY
DC1562B-C	LT06992CS6-1	10kHz, 0 - 100% DUTY CYCLE
DC1562B-D	LT06992CS6-2	10kHz, 5 - 95% DUTY CYCLE
DC1562B-E	LT06992CS6-3	10kHz, 0 - 95% DUTY CYCLE
DC1562B-F	LT06992CS6-4	100ms ONE SHOT, RISING EDGE TRIGGERED
DC1562B-G	LT06993CS6-1	100ms RE-TRIGGERABLE (RISING EDGE) ONE SHOT
DC1562B-H	LT06993CS6-2	100ms ONE SHOT, FALLING EDGE TRIGGERED
DC1562B-I	LT06993CS6-3	100ms RE-TRIGGERABLE (FALLING EDGE) ONE SHOT
DC1562B-J	LT06993CS6-4	100ms OUTPUT FALLING EDGE DELAYED FROM TRIGGER FALLING EDGE
DC1562B-K	LT06994CS6-1	100ms OUTPUT RISING EDGE DELAYED FROM TRIGGER RISING EDGE
DC1562B-L	LT06994CS6-2	1sec. POWER ON RESET
DC1562B-M	LT06995CS6-1	1sec. POWER ON RESET
DC1562B-N	LT06995CS6-2	1sec. POWER ON RESET

**** PSF = Part Specific Function, This Pin's Function is Different Depending On The U1 Part used.**
 NOTE: UNLESS OTHERWISE SPECIFIED
 1. ALL RESISTORS ARE IN 0805.
 ALL CAPACITORS ARE IN 0805.

CUSTOMER NOTICE
 LINEAR TECHNOLOGY HAS MADE A BEST EFFORT TO DESIGN A CIRCUIT THAT MEETS CUSTOMER-SUPPLIED SPECIFICATIONS. HOWEVER, IT REMAINS THE CUSTOMER'S RESPONSIBILITY TO VERIFY PROPER AND RELIABLE OPERATION IN THE ACTUAL APPLICATION. COMPONENT SUBSTITUTION AND PRINTED CIRCUIT BOARD LAYOUT MAY SIGNIFICANTLY AFFECT CIRCUIT PERFORMANCE OR RELIABILITY. CONTACT LINEAR TECHNOLOGY APPLICATIONS ENGINEERING FOR ASSISTANCE.

THIS CIRCUIT IS PROPRIETARY TO LINEAR TECHNOLOGY AND SUPPLIED FOR USE WITH LINEAR TECHNOLOGY PARTS.

APPROVALS

PCB DES.	A.K.
APP ENG.	JIM M.
SCALE	NONE

LINEAR TECHNOLOGY
 1630 McCarthy Blvd.
 Milpitas, CA 95035
 Phone: (408)432-1900 www.linear.com
 Fax: (408)434-0907
 LTC Confidential-For Customer Use Only

TITLE: SCHEMATIC
 TimerBlox™

SIZE	IC NO.	REV.
N/A	LT0699X	1
DATE:	DEMO CIRCUIT 1562B-A/B/C/D/E/F/G/H/I/J/K/L	SHEET 1 OF 1
	Monday, May 06, 2013	



Information furnished by Linear Technology Corporation is believed to be accurate and reliable. However, no responsibility is assumed for its use. Linear Technology Corporation makes no representation that the interconnection of its circuits as described herein will not infringe on existing patent rights.