

FEATURES

- **5V Output Current: 100mA** ($V_{IN} \geq 3V$)
- **3.3V Output Current: 80mA** ($V_{IN} \geq 2.5V$)
- **Ultralow Power: 20 μ A Quiescent Current**
- **Regulated Output Voltage: 3.3V \pm 4%, 5V \pm 4%, ADJ**
- **No Inductors**
- **Short-Circuit/Thermal Protection**
- V_{IN} Range: 2V to 5.5V
- 800kHz Switching Frequency
- Very Low Shutdown Current: <2 μ A
- Shutdown Disconnects Load from V_{IN}
- PowerGood/Undervoltage Output
- Adjustable Soft-Start Time
- Available in an 8-Pin MSOP Package

APPLICATIONS

- Li-Ion Battery Backup Supplies
- Local 3V and 5V Conversion
- Smart Card Readers
- PCMCIA Local 5V Supplies
- White LED Backlighting

DESCRIPTION

The LTC[®]1751 family are micropower charge pump DC/DC converters that produce a regulated output voltage at up to 100mA. The input voltage range is 2V to 5.5V. Extremely low operating current (20 μ A typical with no load) and low external parts count (one flying capacitor and two small bypass capacitors at V_{IN} and V_{OUT}) make them ideally suited for small, battery-powered applications.

The LTC1751 family operate as Burst Mode[™] switched capacitor voltage doublers to achieve ultralow quiescent current. They have thermal shutdown capability and can survive a continuous short circuit from V_{OUT} to GND. The PGOOD pin on the LTC1751-3.3 and LTC1751-5 indicates when the output voltage has reached its final value and if the output has an undervoltage fault condition. The FB pin of the adjustable LTC1751 can be used to program the desired output voltage or current. An optional soft-start capacitor may be used at the SS pin to prevent excessive inrush current during start-up.

The LTC1751 family is available in an 8-pin MSOP package.

LT, LTC and LT are registered trademarks of Linear Technology Corporation. Burst Mode is a trademark of Linear Technology Corporation.

TYPICAL APPLICATION

Regulated 5V Output from a 2.7V to 5.5V Input

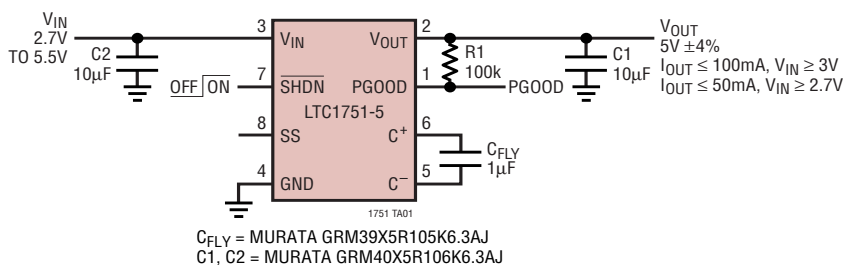

Output Voltage vs Input Voltage

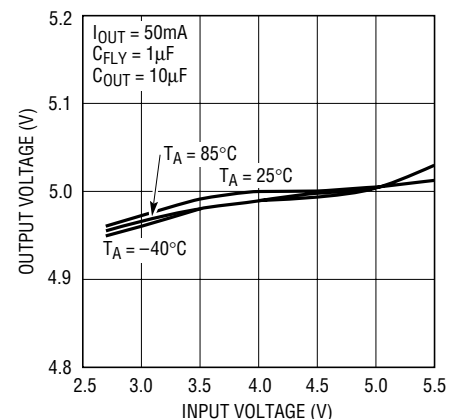

1751 TA02

LTC1751/LTC1751-3.3/LTC1751-5

ABSOLUTE MAXIMUM RATINGS

(Note 1)

V_{IN} to GND	-0.3V to 6V
PGOOD, FB, V_{OUT} to GND	-0.3V to 6V
SS, \overline{SHDN} to GND	-0.3V to ($V_{IN} + 0.3V$)
V_{OUT} Short-Circuit Duration	Indefinite
I_{OUT} (Note 2)	125mA
Operating Temperature Range (Note 3) ..	-40°C to 85°C
Storage Temperature Range	-65°C to 150°C
Lead Temperature (Soldering, 10 sec)	300°C

PACKAGE/ORDER INFORMATION

<p>MS8 PACKAGE 8-LEAD PLASTIC MSOP</p> <p>$T_{JMAX} = 150^{\circ}C$, $\theta_{JA} = 160^{\circ}C/W$ *PGOOD ON LTC1751-3.3/LTC1751-5 FB ON LTC1751</p>	ORDER PART NUMBER
	LTC1751EMS8 LTC1751EMS8-3.3 LTC1751EMS8-5
	MS8 PART MARKING
	LTKL LTKN LTKP

Consult factory for parts specified with wider operating temperature ranges.

ELECTRICAL CHARACTERISTICS

The ● denotes specifications which apply over the full specified temperature range, otherwise specifications are at $T_A = 25^{\circ}C$. $C_{FLY} = 1\mu F$, $C_{IN} = 10\mu F$, $C_{OUT} = 10\mu F$ unless otherwise noted.

SYMBOL	PARAMETER	CONDITIONS	MIN	TYP	MAX	UNITS	
LTC1751-3.3							
V_{IN}	Input Supply Voltage		●	2	4.4	V	
V_{OUT}	Output Voltage	$2V \leq V_{IN} \leq 4.4V$, $I_{OUT} \leq 40mA$	●	3.17	3.3	3.43	V
		$2.5V \leq V_{IN} \leq 4.4V$, $I_{OUT} \leq 80mA$	●	3.17	3.3	3.43	V
I_{CC}	Operating Supply Current	$2V \leq V_{IN} \leq 4.4V$, $I_{OUT} = 0mA$, $\overline{SHDN} = V_{IN}$	●	18	40	μA	
V_R	Output Ripple	$V_{IN} = 2.5V$, $I_{OUT} = 40mA$		68		mV _{p-p}	
η	Efficiency	$V_{IN} = 2V$, $I_{OUT} = 40mA$		80		%	
LTC1751-5							
V_{IN}	Input Supply Voltage		●	2.7	5.5	V	
V_{OUT}	Output Voltage	$2.7V \leq V_{IN} \leq 5.5V$, $I_{OUT} \leq 50mA$	●	4.8	5	5.2	V
		$3V \leq V_{IN} \leq 5.5V$, $I_{OUT} \leq 100mA$	●	4.8	5	5.2	V
I_{CC}	Operating Supply Current	$2.7V \leq V_{IN} \leq 5.5V$, $I_{OUT} = 0mA$, $\overline{SHDN} = V_{IN}$	●	20	50	μA	
V_R	Output Ripple	$V_{IN} = 3V$, $I_{OUT} = 50mA$		75		mV _{p-p}	
η	Efficiency	$V_{IN} = 3V$, $I_{OUT} = 50mA$		82		%	
LTC1751							
V_{IN}	Input Supply Voltage		●	2	5.5	V	
I_{CC}	Operating Supply Current	$2V \leq V_{IN} \leq 5.5V$, $I_{OUT} = 0mA$, $\overline{SHDN} = V_{IN}$ (Note 4)	●	16	40	μA	
V_{FB}	FB Regulation Voltage	$2V \leq V_{IN} \leq 5.5V$, $I_{OUT} \leq 20mA$	●	1.157	1.205	1.253	V
I_{FB}	FB Input Current	$V_{FB} = 1.3V$	●	-50	50	nA	
R_{OUT}	Open-Loop Charge Pump Strength	$V_{IN} = 2V$, $V_{OUT} = 3.3V$ (Note 5)	●	8.5	20	Ω	
		$V_{IN} = 2.7V$, $V_{OUT} = 5V$ (Note 5)	●	6.0	12	Ω	

ELECTRICAL CHARACTERISTICS The ● denotes specifications which apply over the full specified temperature range, otherwise specifications are at $T_A = 25^\circ\text{C}$. $C_{FLY} = 1\mu\text{F}$, $C_{IN} = 10\mu\text{F}$, $C_{OUT} = 10\mu\text{F}$ unless otherwise noted.

SYMBOL	PARAMETER	CONDITIONS	MIN	TYP	MAX	UNITS	
LTC1751-3.3/LTC1751-5							
UVL	PGOOD Undervoltage Low Threshold	Relative to Regulated V_{OUT} (Note 6)	●	-11	-7	-3	%
UVH	PGOOD Undervoltage High Threshold	Relative to Regulated V_{OUT} (Note 6)	●	-8	-4.5	-2	%
V_{OL}	PGOOD Low Output Voltage	$I_{PGOOD} = -500\mu\text{A}$	●			0.4	V
I_{OH}	PGOOD High Output Leakage	$V_{PGOOD} = 5.5\text{V}$	●			1	μA
LTC1751/LTC1751-3.3/LTC1751-5							
I_{SHDN}	Shutdown Supply Current	$V_{IN} \leq 3.6\text{V}$, $V_{OUT} = 0\text{V}$, $V_{SHDN} = 0\text{V}$ $3.6\text{V} < V_{IN}$, $V_{OUT} = 0\text{V}$, $V_{SHDN} = 0\text{V}$	●		0.01	2	μA
V_{IH}	SHDN Input Threshold (High)		●	1.5			V
V_{IL}	SHDN Input Threshold (Low)		●			0.3	V
I_{IH}	SHDN Input Current (High)	$SHDN = V_{IN}$	●	-1		1	μA
I_{IL}	SHDN Input Current (Low)	$SHDN = 0\text{V}$	●	-1		1	μA
t_r	V_{OUT} Rise Time	$V_{IN} = 3\text{V}$, $I_{OUT} = 0\text{mA}$, 10% to 90% (Note 6)			$0.6\text{ms/nF} \cdot C_{SS}$		sec
f_{OSC}	Switching Frequency	Oscillator Free Running			800		kHz

Note 1: Absolute Maximum Ratings are those values beyond which the life of a device may be impaired.

Note 2: Based on long term current density limitations.

Note 3: The LTC1751EMS8-X is guaranteed to meet performance specifications from 0°C to 70°C . Specifications over the -40°C to 85°C operating temperature range are assured by design, characterization and correlation with statistical process controls.

Note 4: The no load input current will be approximately I_{CC} plus twice the standing current in the resistive output divider.

Note 5: $R_{OUT} \equiv (2V_{IN} - V_{OUT})/I_{OUT}$.

Note 6: See Figure 2.

TYPICAL PERFORMANCE CHARACTERISTICS
(LTC1751-3.3)

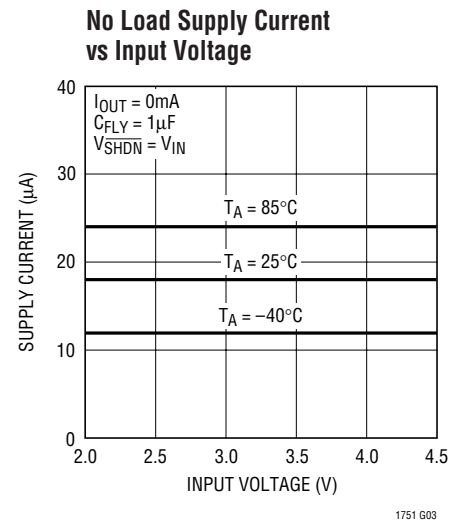
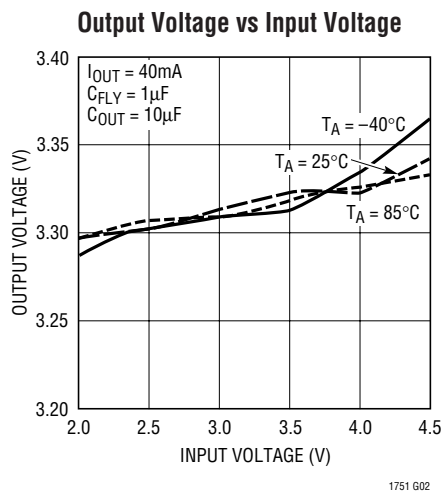
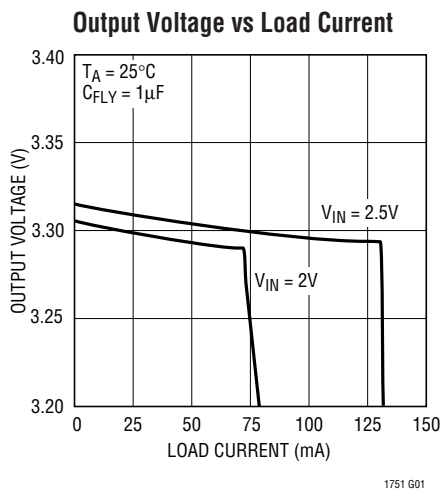

TYPICAL PERFORMANCE CHARACTERISTICS

(LTC1751-3.3)

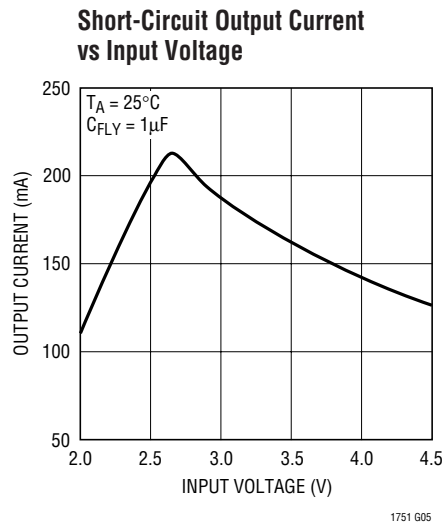
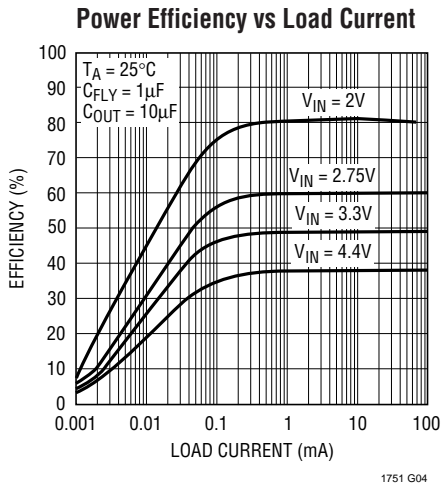

Start-Up

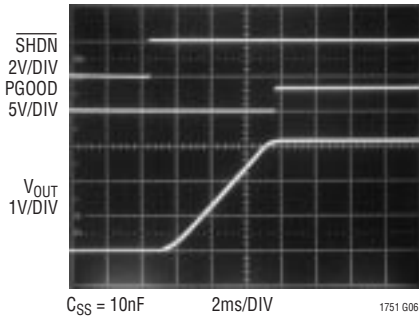

Output Ripple

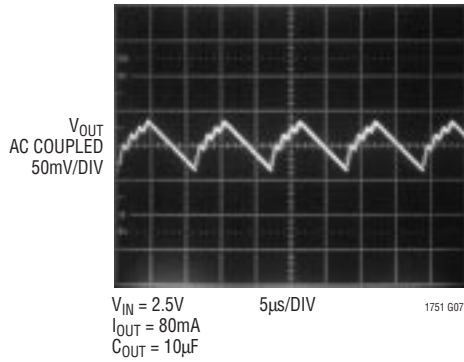

Load Transient Response

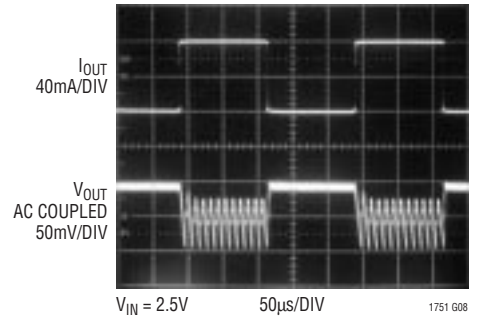

(LTC1751-5)

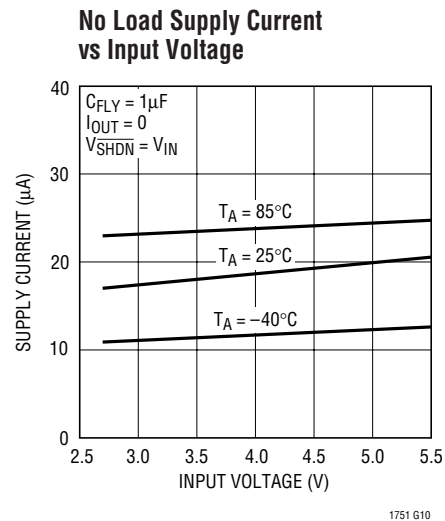
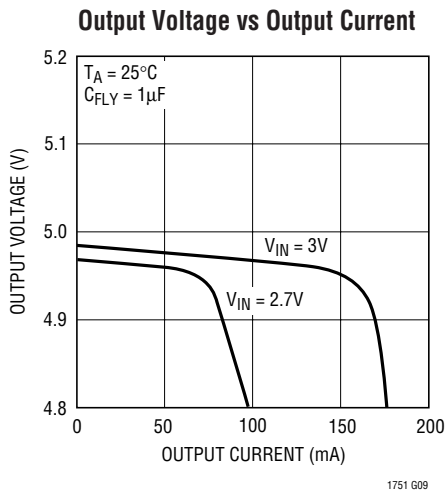

TYPICAL PERFORMANCE CHARACTERISTICS (LTC1751-5)

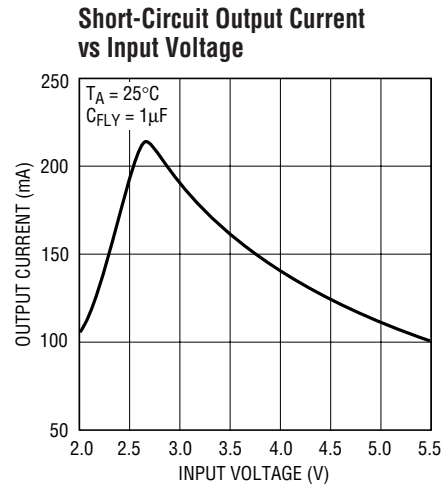
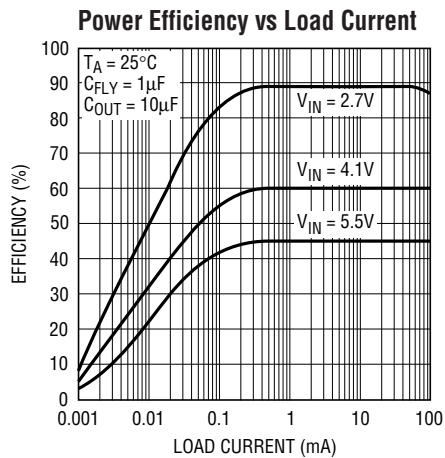
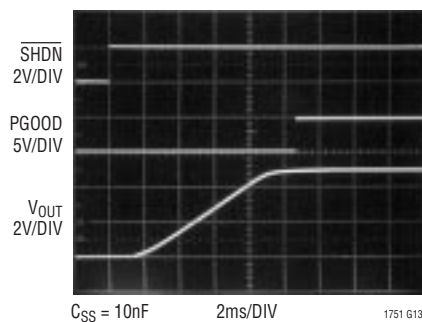
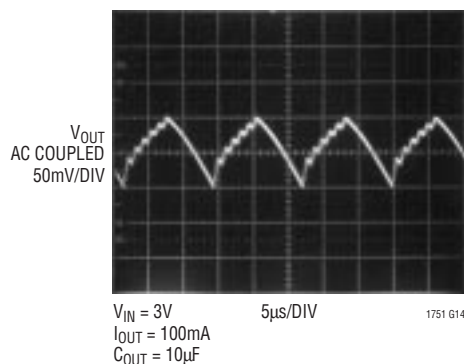
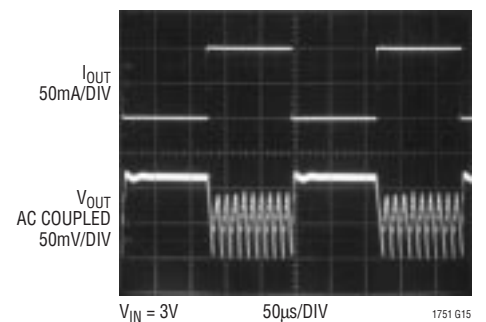
**Start-Up****Output Ripple****Load Transient Response**

PIN FUNCTIONS

PGOOD (Pin 1) (LTC1751-3.3/LTC1751-5): Output Voltage Status Indicator. On start-up, this open-drain pin remains low until the output voltage, V_{OUT} , is within 4.5% (typ) of its final value. Once V_{OUT} is valid, PGOOD becomes high-Z. If, due to a fault condition, V_{OUT} falls 7% (typ) below its correct regulation level, PGOOD pulls low. PGOOD may be pulled up through an external resistor to any appropriate reference level.

FB (Pin 1) (LTC1751): The voltage on this pin is compared to the internal reference voltage (1.205V) by the error comparator to keep the output in regulation. An external resistor divider is required between V_{OUT} and FB to program the output voltage.

V_{OUT} (Pin 2): Regulated Output Voltage. For best performance, V_{OUT} should be bypassed with a 6.8µF (min) low ESR capacitor as close to the pin as possible.

V_{IN} (Pin 3): Input Supply Voltage. V_{IN} should be bypassed with a 6.8µF (min) low ESR capacitor.

GND (Pin 4): Ground. Should be tied to a ground plane for best performance.

C^- (Pin 5): Flying Capacitor Negative Terminal.

C^+ (Pin 6): Flying Capacitor Positive Terminal.

SHDN (Pin 7): Active Low Shutdown Input. A low on SHDN disables the device. SHDN must not be allowed to float.

SS (Pin 8): Soft-Start Programming Pin. A capacitor on SS programs the start-up time of the charge pump so that large start-up input current is eliminated.

SIMPLIFIED BLOCK DIAGRAMS

LTC1751-3.3/LTC1751-5

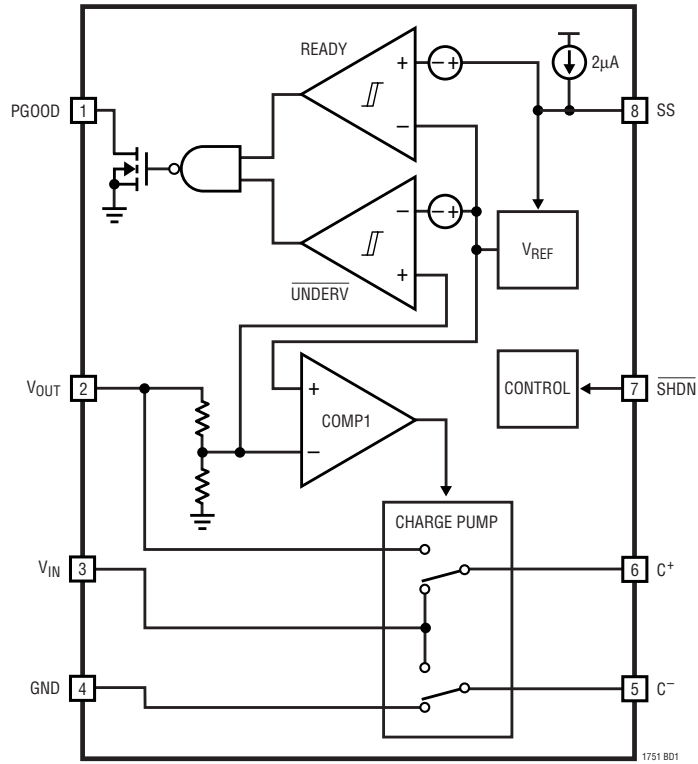

LTC1751

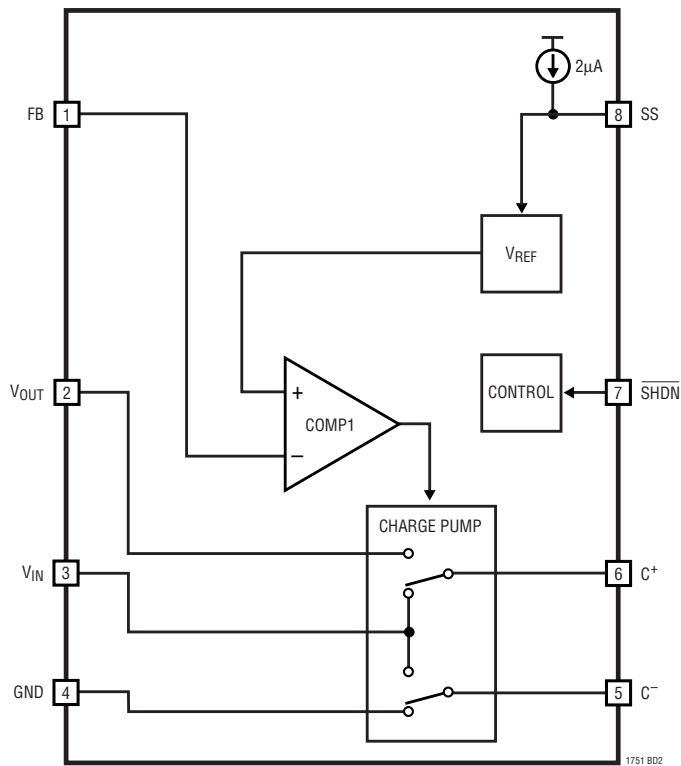

APPLICATIONS INFORMATION

Operation (Refer to Simplified Block Diagrams)

The LTC1751 family uses a switched capacitor charge pump to boost V_{IN} to a regulated output voltage. Regulation is achieved by sensing the output voltage through a resistor divider and enabling the charge pump when the divided output drops below the lower trip point of COMP1. When the charge pump is enabled, a 2-phase nonoverlapping clock activates the charge pump switches. The flying capacitor is charged to V_{IN} on phase 1 of the clock. On phase 2 of the clock, it is stacked in series with V_{IN} and connected to V_{OUT} . This sequence of charging and discharging the flying capacitor continues at the clock frequency until the divided output voltage reaches the upper trip point of COMP1. Once this happens the charge pump is disabled. When the charge pump is disabled the device typically draws less than 20 μ A from V_{IN} thus providing high efficiency under low load conditions.

In shutdown mode all circuitry is turned off and the LTC1751 draws only leakage current from the V_{IN} supply. Furthermore, V_{OUT} is disconnected from V_{IN} . The $\overline{\text{SHDN}}$ pin is a CMOS input with a threshold voltage of approximately 0.8V. The LTC1751 is in shutdown when a logic low is applied to the $\overline{\text{SHDN}}$ pin. The quiescent supply current of the LTC1751 will be slightly higher if the $\overline{\text{SHDN}}$ pin is driven high with a voltage that is below V_{IN} than if it is driven all the way to V_{IN} . Since the $\overline{\text{SHDN}}$ pin is a high impedance CMOS input it should never be allowed to float. To ensure that its state is defined it must always be driven with a valid logic level.

Power Efficiency

The efficiency (η) of the LTC1751 family is similar to that of a linear regulator with an effective input voltage of twice the actual input voltage. This occurs because the input current for a voltage doubling charge pump is approximately twice the output current. In an ideal regulated doubler the power efficiency would be given by:

$$\eta = \frac{P_{OUT}}{P_{IN}} = \frac{V_{OUT} \cdot I_{OUT}}{V_{IN} \cdot 2I_{OUT}} = \frac{V_{OUT}}{2V_{IN}}$$

At moderate to high output power, the switching losses and quiescent current of the LTC1751 are negligible and the expression is valid. For example, an LTC1751-5 with $V_{IN} = 3V$, $I_{OUT} = 50mA$ and V_{OUT} regulating to 5V, has a measured efficiency of 82% which is in close agreement with the theoretical 83.3% calculation. The LTC1751 product family continues to maintain good efficiency even at fairly light loads because of its inherently low power design.

Short-Circuit/Thermal Protection

During short-circuit conditions, the LTC1751 will draw between 200mA and 400mA from V_{IN} causing a rise in the junction temperature. On-chip thermal shutdown circuitry disables the charge pump once the junction temperature exceeds approximately 160°C and re-enables the charge pump once the junction temperature drops back to approximately 150°C. The device will cycle in and out of thermal shutdown indefinitely without latchup or damage until the short circuit on V_{OUT} is removed.

V_{IN} , V_{OUT} Capacitor Selection

The style and value of capacitors used with the LTC1751 family determine several important parameters such as output ripple, charge pump strength and minimum start-up time.

To reduce noise and ripple, it is recommended that low ESR (<0.1 Ω) capacitors be used for both C_{IN} and C_{OUT} . These capacitors should be either ceramic or tantalum and should be 6.8 μ F or greater. Aluminum capacitors are not recommended because of their high ESR. If the source impedance to V_{IN} is very low, up to several megahertz, C_{IN} may not be needed. Alternatively, a somewhat smaller value of input capacitor may be adequate, but will not be as effective in preventing ripple on the V_{IN} pin.

The value of C_{OUT} controls the amount of output ripple. Increasing the size of C_{OUT} to 10 μ F or greater will reduce the output ripple at the expense of higher minimum turn on time and higher start-up current. See the section Output Ripple.

APPLICATIONS INFORMATION

Flying Capacitor Selection

Warning: A polarized capacitor such as tantalum or aluminum should never be used for the flying capacitor since its voltage can reverse upon start-up of the LTC1751. Low ESR ceramic capacitors should always be used for the flying capacitor.

The flying capacitor controls the strength of the charge pump. In order to achieve the rated output current, it is necessary to have at least 0.6 μ F of capacitance for the flying capacitor. Capacitors of different materials lose their capacitance with higher temperature and voltage at different rates. For example, a ceramic capacitor made of X7R material will retain most of its capacitance from -40°C to 85°C , whereas, a Z5U or Y5V style capacitor will lose considerable capacitance over that range. Z5U and Y5V capacitors may also have a very strong voltage coefficient causing them to lose 50% or more of their capacitance when the rated voltage is applied. The capacitor manufacturer's data sheet should be consulted to determine what value of capacitor is needed to ensure 0.6 μ F at all temperatures and voltages.

Generally an X7R ceramic capacitor is recommended for the flying capacitor with a minimum value of 1 μ F. For very low load applications, it may be reduced to 0.01 μ F-0.68 μ F. A smaller flying capacitor delivers less charge per clock cycle to the output capacitor resulting in lower output ripple. The output ripple is reduced at the expense of maximum output current and efficiency.

The theoretical minimum output resistance of a voltage doubling charge pump is given by:

$$R_{\text{OUT(MIN)}} \equiv \frac{2V_{\text{IN}} - V_{\text{OUT}}}{I_{\text{OUT}}} = \frac{1}{fC}$$

Where f is the switching frequency and C is the value of the flying capacitor. (Using units of MHz and μ F is convenient since they cancel each other.) Note that the charge pump will typically be weaker than the theoretical limit due to additional switch resistance. However, for light load applications, the above expression can be used as a guideline in determining a starting capacitor value.

Below is a list of ceramic capacitor manufacturers and how to contact them:

AVX	www.avxcorp.com
Kemet	www.kemet.com
Murata	www.murata.com
Taiyo Yuden	www.t-yuden.com
Vishay	www.vishay.com

Output Ripple

Low frequency *regulation mode* ripple exists due to the hysteresis in the sense comparator and propagation delays in the charge pump control circuits. The amplitude and frequency of this ripple are heavily dependent on the load current, the input voltage and the output capacitor size. For large V_{IN} the ripple voltage can become substantial because the increased strength of the charge pump causes fast edges that may outpace the regulation circuitry. In some cases, rather than bursting, a single output cycle may be enough to boost the output voltage into or possibly beyond regulation. In these cases the average output voltage will climb slightly. For large input voltages a larger output capacitor will ensure that bursting always occurs, thus mitigating possible DC problems. Generally the regulation ripple has a sawtooth shape associated with it.

A high frequency ripple component may also be present on the output capacitor due to the charge transfer action of the charge pump. In this case, the output can display a voltage pulse during the output-charging phase. This pulse results from the product of the charging current and the ESR of the output capacitor. It is proportional to the input voltage, the value of the flying capacitor and the ESR of the output capacitor.

For example, typical combined output ripple for an LTC1751-5 with $V_{\text{IN}} = 3\text{V}$ under maximum load is 75mV_{P-P} with a low ESR 10 μ F output capacitor. A smaller output capacitor and/or larger output current load will result in higher ripple due to higher output voltage slew rates.

APPLICATIONS INFORMATION

There are several ways to reduce output voltage ripple. For applications requiring V_{IN} to exceed 3.3V or for applications requiring $< 100\text{mV}$ of peak-to-peak ripple, a larger C_{OUT} capacitor ($22\mu\text{F}$ or greater) is recommended. A larger capacitor will reduce both the low and high frequency ripple due to the lower charging and discharging slew rates as well as the lower ESR typically found with higher value (larger case size) capacitors. A low ESR ceramic output capacitor will minimize the high frequency ripple, but will not reduce the low frequency ripple unless a high capacitance value is used. An R-C filter may also be used to reduce high frequency voltages spikes (see Figure 1).

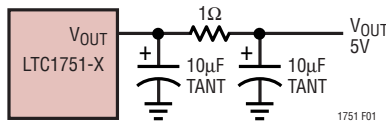

Figure 1. Output Ripple Reduction Technique

Note that when using a larger output capacitor the minimum turn-on time of the device will increase.

Soft-Start

The LTC1751 family has built-in soft-start circuitry to prevent excessive current flow at V_{IN} during start-up. The soft-start time is programmed by the value of the capacitor at the SS pin. Typically a $2\mu\text{A}$ current is forced out of SS causing a ramp voltage on the SS pin. The regulation loop follows this ramp voltage until the output reaches the correct regulation level. SS is automatically pulled to ground whenever $\overline{\text{SHDN}}$ is low. The typical rise time is given by the expression:

$$t_r = 0.6\text{ms/nF} \cdot C_{SS}$$

For example, with a 4.7nF capacitor the 10% to 90% rise time will be approximately 2.8ms. If the output charge storage capacitor is $10\mu\text{F}$, then the average output current for an LTC1751-5 will be $4\text{V}/2.8\text{ms} \cdot 10\mu\text{F}$ or 14mA, giving 28mA at the V_{IN} pin.

The soft-start feature is optional. If there is no capacitor on SS, the output voltage of the LTC1751 will ramp up as quickly as possible. The start-up time will depend on

various parameters such as temperature, output loading, charge pump and flying capacitor values and input voltage.

PGOOD and Undervoltage Detection

The PGOOD pin on the LTC1751-3.3/LTC1751-5 performs two functions. On start-up, it indicates when the output has reached its final regulation level. After start-up, it indicates when a fault condition, such as excessive loading, has pulled the output out of regulation.

Once the LTC1751-3.3/LTC1751-5 are enabled via the $\overline{\text{SHDN}}$ pin, V_{OUT} ramps to its final regulation value slowly by following the SS pin. The PGOOD pin switches from low impedance to high impedance after V_{OUT} reaches its regulation value. If V_{OUT} is subsequently pulled below its correct regulation level, the PGOOD pin pulls low again indicating that a fault exists. Alternatively, if there is a short circuit on V_{OUT} preventing it from ever reaching its correct regulation level, the PGOOD pin will remain low. The lower fault threshold, UVL, is preprogrammed to recognize errors of -7% below nominal V_{OUT} . The upper fault threshold, UVH, is preprogrammed at -4.5% below nominal. Figure 2 shows an example of the PGOOD pin with a normal start-up followed by an undervoltage fault.

Using an external pull-up resistor, the PGOOD pin can be pulled high from any available voltage supply, including the LTC1751-3.3/LTC1751-5 V_{OUT} pin.

If PGOOD is not used it may be connected to GND.

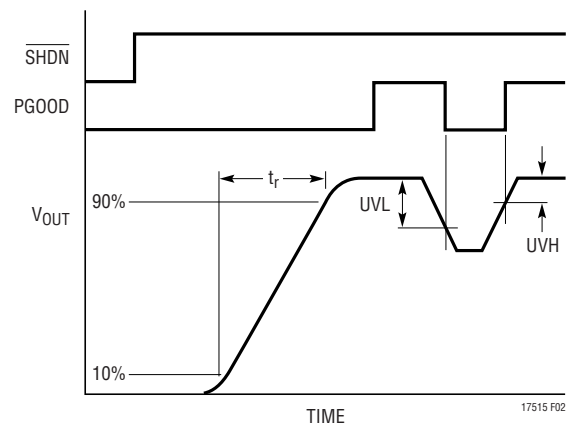

Figure 2. PGOOD During Start-Up and Undervoltage

APPLICATIONS INFORMATION

Programming the LTC1751 Output Voltage (FB Pin)

While the LTC1751-3.3/LTC1751-5 versions have internal resistive dividers to program the output voltage, the programmable LTC1751 may be set to an arbitrary voltage via an external resistive divider. Since it employs a voltage doubling charge pump, it is not possible to achieve output voltages greater than twice the available input voltage. Figure 3 shows the required voltage divider connection.

The voltage divider ratio is given by the expression:

$$\frac{R1}{R2} = \frac{V_{OUT}}{1.205V} - 1$$

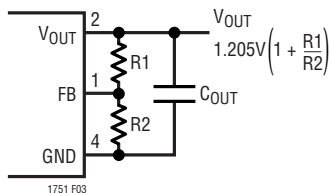

Figure 3. Programming the Adjustable LTC1751

The sum of the voltage divider resistors can be made large to keep the quiescent current to a minimum. Any standing current in the output divider (given by $1.205V/R2$) will be reflected by a factor of 2 in the input current. Typical values for total voltage divider resistance can range from several $k\Omega$ s up to $1M\Omega$.

Maximum Available Output Current

For the adjustable LTC1751, the maximum available output current and voltage can be calculated from the effective open-loop output resistance, R_{OUT} , and effective output voltage, $2V_{IN(MIN)}$.

From Figure 4 the available current is given by:

$$I_{OUT} = \frac{2V_{IN} - V_{OUT}}{R_{OUT}}$$

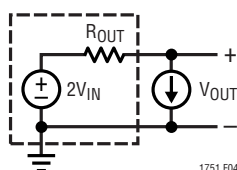

Figure 4. Equivalent Open-Loop Circuit

Typical R_{OUT} values as a function of input voltage are shown in Figure 5.

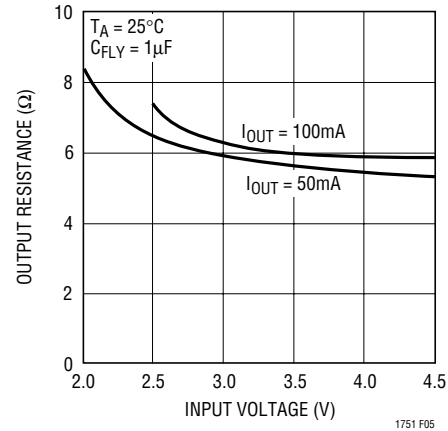

Figure 5. Typical R_{OUT} vs Input Voltage

Layout Considerations

Due to high switching frequency and high transient currents produced by the LTC1751 product family, careful board layout is necessary. A true ground plane and short connections to all capacitors will improve performance and ensure proper regulation under all conditions. Figure 6 shows the recommended layout configuration.

Thermal Management

For higher input voltages and maximum output current, there can be substantial power dissipation in the LTC1751. If the junction temperature increases above approximately $160^{\circ}C$, the thermal shutdown circuitry will automatically deactivate the output. To reduce the maximum junction temperature, a good thermal connection to the PC board is recommended. Connecting the GND pin (Pin 4) to a ground plane, and maintaining a solid ground plane under the device on two layers of the PC board, will reduce the thermal resistance of the package and PC board system considerably.

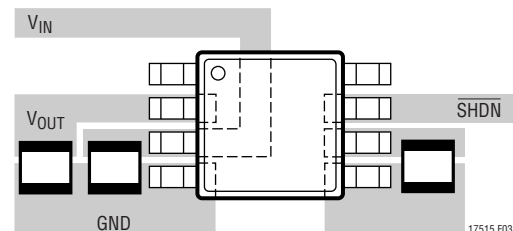

Figure 6. Recommended Layout

