

# Lithium-Ion Battery Pulse Charger with Overcurrent Protection

## FEATURES

- Complete Pulse Charger for 1-Cell Lithium-Ion Batteries
- Sense Resistor Limits Maximum Current for Safety
- 1% Float Voltage Accuracy
- End-of-Charge (C/10) Detection Output
- Programmable Charge Termination Timer
- Internal  $0.35\Omega$  NMOS Switch
- No Blocking Diode Required
- SEL Pin to Set Either 4.1V or 4.2V/Cell (LTC1730-4)
- Low-Battery Drain ( $1\mu\text{A}$  Max) when Input Supply Is Removed
- Battery Temperature Sensing and Charge Qualification
- Automatic Trickle Charge for Low-Battery
- Automatic Battery Refresh

## APPLICATIONS

- Standalone Lithium-Ion Battery Charger
- Handheld Computers
- Cellular Telephones

## DESCRIPTION

The LTC<sup>®</sup>1730 is a complete pulse charger for 1-cell lithium-ion batteries. When charging a depleted cell, the internal MOSFET is fully on allowing the current limited input power source to provide charge current to the battery, virtually eliminating heat generation in the charger.

As the battery accepts charge and approaches the programmed voltage, the internal MOSFET begins switching off and on with the duty cycle gradually decreasing as the battery approaches a fully charged condition. A programmable timer ends the charge cycle. The end-of-charge condition is indicated at the  $\overline{\text{CHRG}}$  pin when the average charge current falls to C/10. Removing the input voltage puts the LTC1730 into a sleep mode, dropping the battery current drain to less than  $1\mu\text{A}$  (maximum).

An external sense resistor limits the maximum charge current as a safety precaution against a user connecting a wall adapter with the incorrect or no current limit. The internal MOSFET prevents reverse battery current from flowing if the input voltage is shorted to ground, eliminating the need for a blocking diode.

The LTC1730-4 is available in the 16-pin SSOP package and the LTC1730-4.2 is available in the 8-pin SO package.

 LTC and LT are registered trademarks of Linear Technology Corporation.

## TYPICAL APPLICATION

1A, Single Cell 4.2V Li-Ion Battery Charger (8-Pin Package)

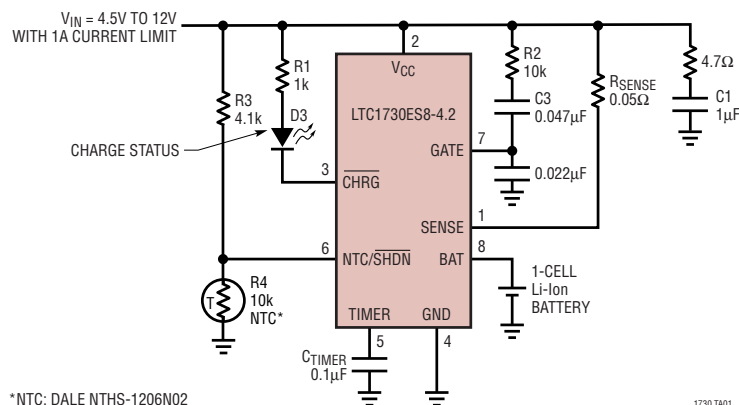

\*NTC: DALE NTHS-1206N02

1730 TA01

sn1730 1730fs

# LTC1730-4/LTC1730-4.2

## ABSOLUTE MAXIMUM RATINGS (Note 1)

Supply Voltage ( $V_{CC}$ ) ..... 13.2V  
 SENSE, GATE, BAT,  
 TIMER, NTC/SHDN, SEL .....  $-0.3V$  to  $V_{CC}$   
 CHRG, ACPR, FAULT .....  $-0.3V$  to 13.2V

Operating Junction  
 Temperature Range (Note 2) .....  $-40^{\circ}C$  to  $85^{\circ}C$   
 Storage Temperature Range .....  $-65^{\circ}C$  to  $150^{\circ}C$   
 Lead Temperature (Soldering, 10 sec) .....  $300^{\circ}C$

## PACKAGE/ORDER INFORMATION

<p>GN PACKAGE 16-LEAD PLASTIC SSOP</p> <p>* FOUR CORNER PINS ARE FUSED TO INTERNAL DIE ATTACH PADDLE FOR HEAT SINKING. CONNECT THESE FOUR PINS TO EXPANDED PC LANDS FOR PROPER HEAT SINKING.                  ** NO INTERNAL CONNECTION</p> <p><math>T_{JMAX} = 125^{\circ}C</math>, <math>\theta_{JA} = 90^{\circ}C/W</math></p>	ORDER PART NUMBER	<p>S8 PACKAGE 8-LEAD PLASTIC SO</p> <p><math>T_{JMAX} = 125^{\circ}C</math>, <math>\theta_{JA} = 110^{\circ}C/W</math></p>	ORDER PART NUMBER
	LTC1730EGN-4		LTC1730ES8-4.2
	GN PART MARKING		S8 PART MARKING
17304	173042		

Consult LTC Marketing for parts specified with wider operating temperature ranges.

## DC ELECTRICAL CHARACTERISTICS The ● denotes the specifications which apply over the full operating temperature range, otherwise specifications are at $T_A = 25^{\circ}C$ . $V_{CC} = 6V$ unless otherwise noted.

SYMBOL	PARAMETER	CONDITIONS	MIN	TYP	MAX	UNITS	
$V_{CC}$	Supply Voltage		● 4.5		12	V	
$I_{CC}$	Supply Current	Charger On; Fast Charge Mode	●	2	5	mA	
		Shutdown: $V_{NTC/SHDN} = 0V$	●	2	5	mA	
		Sleep Mode; $V_{BAT} = 4V$	●		1	$\mu A$	
$V_{BAT}$	Regulated Output Voltage	LTC1730ES8-4.2 ( $5V \leq V_{CC} \leq 12V$ )	●	4.158	4.2	4.242	V
		LTC1730EGN-4 ( $5V \leq V_{CC} \leq 12V$ ), SEL = GND	●	4.059	4.1	4.141	V
		LTC1730EGN-4 ( $5V \leq V_{CC} \leq 12V$ ), SEL = $V_{CC}$	●	4.158	4.2	4.242	V
$I_{MAX}$	Maximum Charge Overcurrent	$R_{SENSE} = 0.1\Omega$	● 0.7	1	1.3	A	
$I_{TRICKL}$	Trickle Charge Current	$V_{BAT} = 2V$		15	35	60	mA
$V_{TRICKL}$	Trickle Charge Trip Threshold			2.45	2.55	V	
$V_{ASD}$	Automatic Shutdown Threshold Voltage (Sleep Mode)	$(V_{CC} - V_{BAT})$ Low to High			150	mV	
		$(V_{CC} - V_{BAT})$ High to Low		0		mV	
$R_{DS(ON)}$	Internal Switch On-Resistance	$V_{BAT} = 4V$		0.35		$\Omega$	
$V_{SHDN}$	Shutdown Threshold Voltage	NTC/SHDN Pin High to Low			50	mV	

sn1730 1730fs

## DC ELECTRICAL CHARACTERISTICS

The ● denotes the specifications which apply over the full operating temperature range, otherwise specifications are at  $T_A = 25^\circ\text{C}$ .  $V_{CC} = 6\text{V}$  unless otherwise noted.

SYMBOL	PARAMETER	CONDITIONS	MIN	TYP	MAX	UNITS
$I_{\text{CHRG}}$	CHRG Pin Pull-Down Current	$V_{\text{CHRG}} = 1\text{V}$ , C/10 Mode	10	40	70	$\mu\text{A}$
$T_{\text{TIMER}}$	TIMER Accuracy	$C_{\text{TIMER}} = 0.1\mu\text{F}$			10	%
$V_{\text{GATE}}$	GATE Pin Voltage	$V_{\text{BAT}} = 3\text{V}$ $V_{\text{BAT}} = 4\text{V}$		7.5 10		V V
$T_{\text{SHDN}}$	Thermal Shutdown Temperature			140		$^\circ\text{C}$
$\Delta T_{\text{SHDN}}$	Thermal Shutdown Hysteresis			5		$^\circ\text{C}$
$\Delta V_{\text{RECHRG}}$	Recharge Battery Voltage Offset from Full Charged Battery Voltage	$V_{\text{BAT}}(\text{Full Charged}) - V_{\text{RECHRG}}$ (Note 3)		150		mV
$V_{\text{NTC\_HOT}}$	NTC/SHDN Pin Threshold Voltage (Hot)	High to Low; $V_{\text{CC}} = 4\text{V}$ Hysteresis	● 1.95	2 50	2.05	V mV
$V_{\text{NTC\_COLD}}$	NTC/SHDN Pin Threshold Voltage (Cold)	Low to High; $V_{\text{CC}} = 4\text{V}$ Hysteresis	● 3.4	3.5 45	3.6	V mV
$V_{\text{SEL}}$	SEL Pin Threshold	LTC1730ECGN-4		0.7		V
$V_{\text{ACPR}}$	ACPR Pin Output Low Voltage	LTC1730EGN-4, $I_{\text{ACPR}} = 5\text{mA}$			0.6	V
$V_{\text{FAULT}}$	FAULT Pin Output Low Voltage	LTC1730EGN-4, $I_{\text{FAULT}} = 3\text{mA}$			1.2	V
$V_{\text{CHRG}}$	CHRG Pin Output Low Voltage	$I_{\text{CHRG}} = 5\text{mA}$ , Charging Mode			0.9	V

**Note 1:** Absolute Maximum Ratings are those values beyond which the life of a device may be impaired.

**Note 2:** The LTC1730-4/LTC1730-4.2 are guaranteed to meet performance specifications from  $0^\circ\text{C}$  to  $70^\circ\text{C}$ . Specifications over the  $-40^\circ\text{C}$  to  $85^\circ\text{C}$

operating temperature range are assured by design, characterization and correlation with statistical process controls.

**Note 3:** For the LTC1730-4 version, the full charged  $V_{\text{BAT}}$  value is typically 4.1V.

## TYPICAL PERFORMANCE CHARACTERISTICS

**Trickle Charge Current vs Input Supply Voltage**

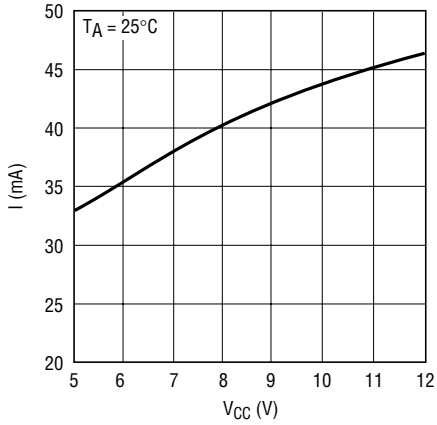

1730 G01

**Trickle Charge Threshold Voltage vs Temperature**

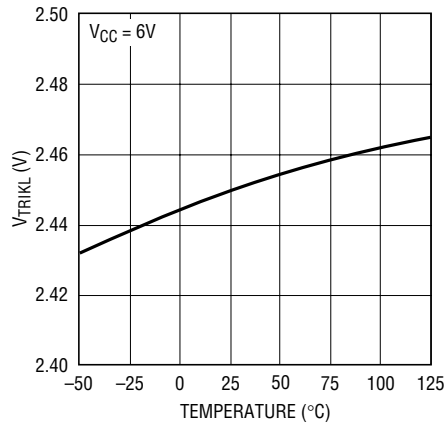

1730 G02

**Trickle Charge Current vs Temperature**

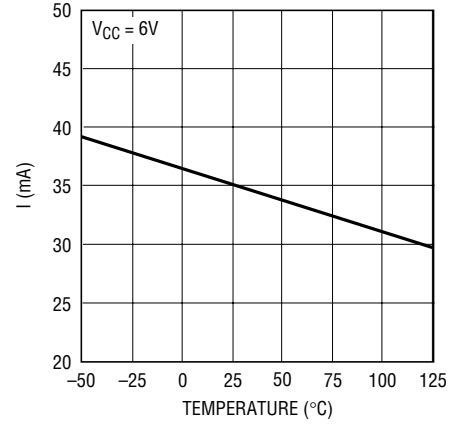

1730 G03

**Internal Switch On-Resistance vs Temperature**

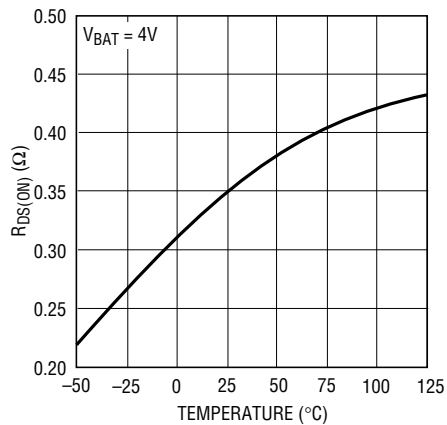

1730 G05

**Timer Accuracy vs Temperature**

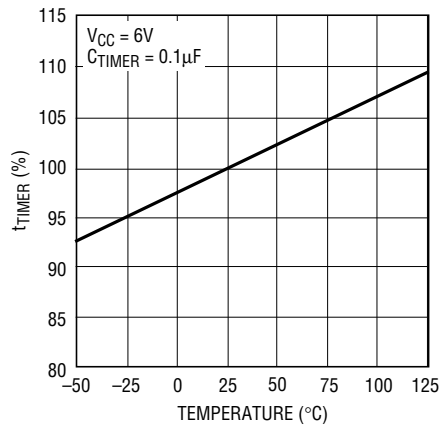

1730 G06

**Overcurrent vs Temperature**

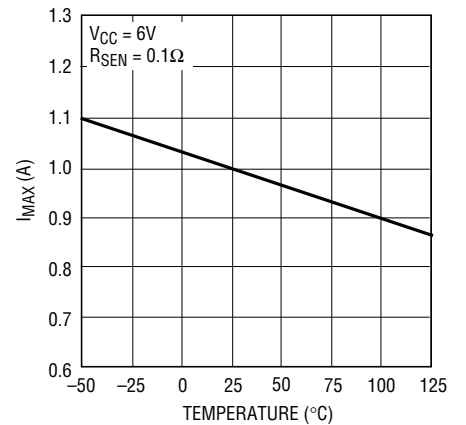

1730 G07

**Battery Recharge Threshold Offset from V<sub>BAT</sub> vs Temperature**

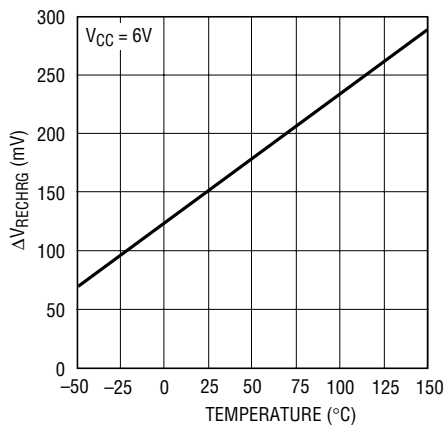

1730 G09

**CHRG Pin Output Low Voltage vs Temperature**

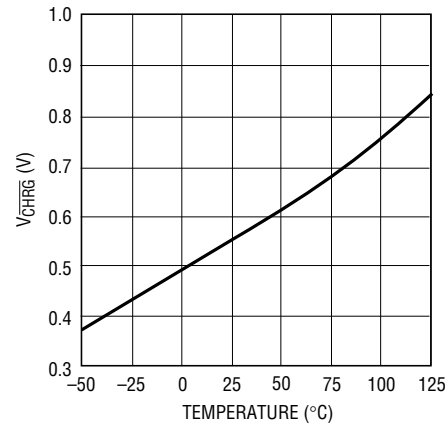

1730 G08

## PIN FUNCTIONS

### LTC1730ES8-4.2

**SENSE (Pin 1):** Maximum Overcurrent Sense Input. A sense resistor ( $R_{SENSE}$ ) should be connected from  $V_{CC}$  to the SENSE pin. When the voltage drop across  $R_{SENSE}$  exceeds 100mV, the pass transistor immediately turns off and turns back on after a 400ms time-out period ( $C_{TIMER} = 0.1\mu F$ ). The on-off cycle will continue, as long as the overcurrent condition persists or until the timer runs out. If overcurrent protection is not needed, short SENSE to  $V_{CC}$ .

**$V_{CC}$  (Pin 2):** Positive Input Supply Voltage ( $4.5V \leq V_{CC} \leq 13.2V$ ). Bypass this pin with a  $1\mu F$  capacitor in series with a  $4.7\Omega$  resistor. An RC network from the  $V_{CC}$  pin to the GATE pin is also required. The capacitor controls the slew rate at the  $V_{CC}$  pin, while the resistor limits the inrush current when the input voltage is first applied. When the pass transistor turns on,  $V_{CC}$  ramps down in a controlled manner, with a slope equal to  $10\mu A/C$ . When the pass transistor turns off,  $V_{CC}$  ramps up with a slope of  $40\mu A/C$ .

**CHRG (Pin 3):** Open-Drain Charge Status Output. When a depleted battery is being charged, the  $\overline{CHRG}$  pin is pulled to ground by an N-MOSFET capable of driving an LED. Once the duty cycle at the GATE pin drops below 10%, the N-MOSFET turns off and a weak  $40\mu A$  current source to ground turns on to indicate a near end-of-charge (C/10) condition. When a time-out occurs or the input supply is removed, the  $\overline{CHRG}$  pin goes high impedance.

**GND (Pin 4):** Electrical Ground Connection and provides a thermal path from the IC to the PC board copper. Use large copper pads and traces for maximum heat transfer.

**TIMER (Pin 5):** Timer Set Pin. The timer period is set by a capacitor ( $C_{TIMER}$ ) to ground. The timer period is:  $t_{TIMER} = (C_{TIMER} \cdot 3Hr)/(0.1\mu F)$ . The minimum ON time, OFF time and the overcurrent time-out period are all set by the same timer period.

**NTC/ $\overline{SHDN}$  (Pin 6):** Input to the NTC (Negative Temperature Coefficient) Thermistor Monitoring and Shutdown Circuitry. With an external  $10k\Omega$  NTC thermistor to ground and a 1% resistor to  $V_{CC}$ , this pin can sense the temperature of the battery pack and stop charging when the temperature is out of range. When the voltage at this pin drops below  $0.5 \cdot V_{CC}$ , or 2V at hot temperature or rises

above  $0.875 \cdot V_{CC}$ , or 3.5V at cold (with  $V_{CC} = 4V$ ), the charge cycle is suspended and the internal timer is frozen. The  $\overline{CHRG}$  pin output status is not affected in this hold state.

When this pin is pulled below 50mV, the IC goes into the shutdown mode. The charging stops (the  $\overline{GATE}$  pin is pulled to ground) the timer is reset and the  $\overline{CHRG}$  pin goes into a high impedance state.

**GATE (Pin 7):** Gate Drive Output Pin for Internal and External Pass Transistors. An external N-MOSFET transistor can be connected in parallel with the internal transistor to reduce the on-resistance for higher charge current. In this case, an external blocking diode is required to prevent damage to the battery if  $V_{CC}$  is shorted to ground. A  $10\mu A$  current source pulls this pin up to the charge pump potential when turned on and a  $40\mu A$  current source pulls it down to ground to turn it off. If an overcurrent condition is detected, the GATE pin is immediately pulled to ground.

A series RC network from the GATE to the  $V_{CC}$  pin is required to control the slew rate at the  $V_{CC}$  pin when the switch is turned on or off. The slew rate control prevents excessive current from the capacitor located in the wall adapter from flowing into the battery when the pass transistor is turned on. The voltage at this pin is internally clamped to 12V above the BAT pin.

**BAT (Pin 8):** Battery Sense Input Pin. This pin is clamped to 4.7V if the battery is disconnected while charging. An internal resistor divider presets the final float voltage to 4.2V.

If the voltage at the BAT pin drops 150mV below final float voltage after the charge cycle has ended, the timer resets and a new charge cycle begins.

### LTC1730EGN-4

**GND (Pins 1, 8, 9, 16):** Refer to LTC1730ES8-4.2

**SENSE (Pin 2):** Refer to LTC1730ES8-4.2

**$V_{CC}$  (Pin 3):** Refer to LTC1730ES8-4.2

**ACPR (Pin 4):** Wall Adapter Present Open-Drain Output. When the input voltage (wall adapter) is applied to the LTC1730, this pin is pulled to ground by an internal

## PIN FUNCTIONS

N-channel MOSFET. This output can sink up to 5mA suitable for driving an LED.

**FAULT (Pin 5):** Fault Condition Detection Open-Drain Output. This output can sink up to 3mA suitable for driving an external LED. The internal N-channel MOSFET pulls this pin to ground when either one of the following conditions is detected:

1. The voltage at the NTC pin is out of the normal operation range. This usually means the battery pack temperature is too high or too low. Once the temperature is back to normal, the  $\overline{\text{FAULT}}$  pin becomes high impedance.
2. The BAT pin potential stays below 2.45V for more than 1/4 of the programmed charge time. When this

condition is detected, the  $\overline{\text{FAULT}}$  pin is pulled low and latched.

**CHRG (Pin 6):** Refer to LTC1730ES8-4.2

**NC (Pins 7, 14):** No Internal Connection. Connecting these pins to ground will help transfer heat from the package.

**TIMER (Pin 10):** Refer to LTC1730ES8-4.2

**NTC/SHDN (Pin 11):** Refer to LTC1730ES8-4.2

**SEL (Pin 12):** 4.1V/4.2V Battery Selection Input. Grounding this pin will set the output float voltage to 4.1V, while connecting to  $V_{CC}$  will set the voltage to 4.2V.

**GATE (Pin 13):** Refer to LTC1730ES8-4.2

**BAT (Pin 15):** Refer to LTC1730ES8-4.2

## BLOCK DIAGRAM

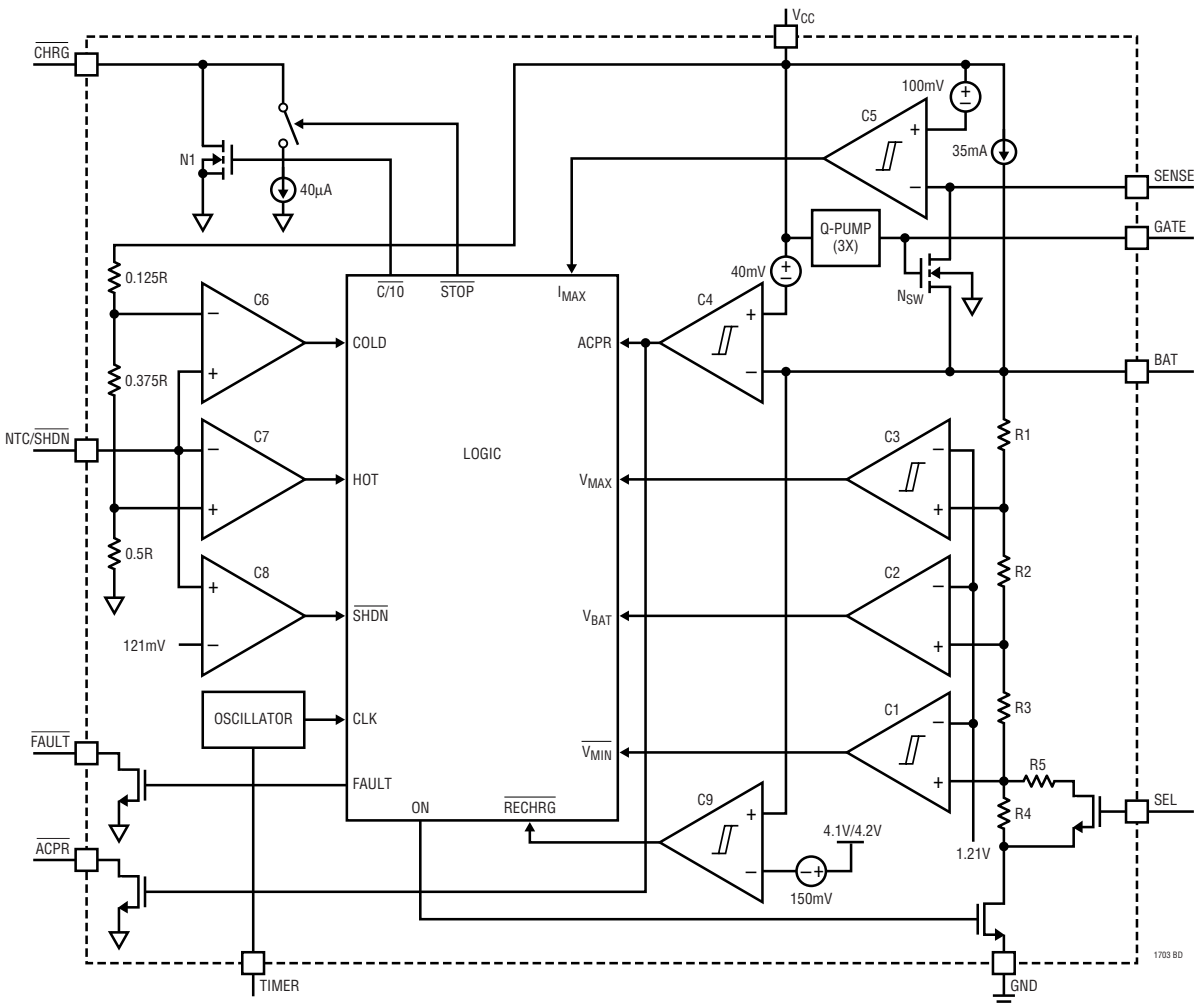

sn1730 1730fs

## OPERATION

The LTC1730 is a complete lithium-ion battery pulse charger with an internal  $0.35\Omega$  N-MOSFET switch driven by an internal charge pump. **The charge current is set by the current limit of the input supply (wall adapter).** An external  $R_{\text{SENSE}}$  sets the maximum allowable charge over current ( $I_{\text{MAX}} = 0.1\text{V}/R_{\text{SENSE}}$ ) and prevents a wall adapter with the wrong current limit from damaging the battery. If the current limit of the input supply is above  $I_{\text{MAX}}$ , the charging will be immediately terminated and will retry after 400ms ( $C_{\text{TIMER}} = 0.1\mu\text{F}$ ). If the battery is disconnected while in fast charge mode, the N-channel MOSFET turns off when the voltage at the BAT pin rises above 4.7V, and turns back on when the voltage drops below the float voltage.

A charge cycle begins when the voltage at the  $V_{\text{CC}}$  pin rises above the BAT pin by 40mV and the voltage at the NTC/SHDN pin is in between  $0.5 \cdot V_{\text{CC}}$  and  $0.875 \cdot V_{\text{CC}}$ . The charger will go into trickle charge mode if the battery voltage is below 2.45V. The trickle charge current is preset to 35mA and is provided by an internal current source. In trickle mode, the charge pump and pass transistor are off.

When the battery voltage exceeds 2.45V, the charger goes into the fast charge mode. In this mode, the charge pump turns on and ramps up the gate voltage of the pass transistor turning it on. The voltage at the  $V_{\text{CC}}$  pin then ramps down to  $V_{\text{BAT}}$  plus the voltage drop across the pass transistor and  $R_{\text{SENSE}}$ , thus reducing the power dissipation in the pass transistor. **The charge current is determined by the current limit of the input supply.**

When the battery voltage reaches the final float voltage, the pass transistor turns off for 100ms (minimum off-time). It remains off as long as the battery voltage stays above the float voltage after the 100ms off-time. After the minimum off-time, if the battery voltage drops below the float voltage, the pass transistor turns back on for at least 380ms (minimum on-time). As the battery approaches full charge, the off-time will get longer and the on-time will stay at 380ms. The voltage at the BAT pin will be slightly higher than the final float voltage due to the ESR associated with the battery pack. This voltage level should not turn on the overvoltage protection circuitry often located in the battery pack. When the duty cycle at the GATE pin drops below 10%, a comparator turns off the N-FET at the  $\overline{\text{CHRG}}$  pin and connects a weak current source ( $40\mu\text{A}$ ) to ground to indicate a near end-of-charge (C/10) condition. The pulse charging will continue until the timer stops.

An external capacitor at the TIMER pin sets the total charge time, the minimum on- and off-time and the overcurrent retry period. After a time-out has occurred, the charge cycle is terminated and the  $\overline{\text{CHRG}}$  pin is forced high impedance. To restart the charge cycle, momentarily pull the NTC/SHDN pin below 50mV or remove and reapply the input voltage. After the charging stops, if the battery voltage drops 150mV below the final float voltage, due to external loading or internal leakage, a new charge cycle will automatically begin.

The charger can be shut down by pulling the NTC/SHDN pin to ground. When the input voltage is not present, the charger goes into a sleep mode, dropping battery drain current to less than  $1\mu\text{A}$ .

## APPLICATIONS INFORMATION

### Stop Charging

The charger is off when any of the following conditions exist. The voltage at the  $V_{CC}$  pin is less than 40mV above  $V_{BAT}$  (sleep mode), or the potential at the  $\overline{NTC}/\overline{SHDN}$  pin is less than 50mV (shutdown mode). The trickle charge current source and the internal pass transistor are turned off. The internal resistor divider is disconnected to reduce the current drain on the battery when in sleep mode.

### Input Voltage (Wall Adapter)

The input voltage to the LTC1730 must have some method of current limit capability. The current limit level of the input power source must be lower than the overcurrent limit ( $I_{MAX}$ ) set by the sense resistor ( $I_{MAX} = 100\text{mV}/R_{SENSE}$ ). If a wall adapter without current limit is used, or the current limit level is above  $I_{MAX}$ , the charger will turn on briefly and then immediately turn off after the overcurrent condition is detected. This cycle will be resumed every 400ms ( $C_{TIMER} = 0.1\mu\text{F}$ ) until the total charge time has run out. If overcurrent protection is not needed, short the SENSE pin to  $V_{CC}$ .

### Trickle Charge and Defective Battery Detection

At the beginning of the charge cycle, if the cell voltage is low (less than 2.45V) the charger goes into a 35mA trickle charge mode. If the low cell voltage persists for one quarter of the total charge time, the battery is considered defective and the charge cycle is terminated. The  $\overline{CHRG}$  pin output is then forced to a high impedance state.

### Battery Charge Current

The battery charge current is determined by the current limit of the input supply (wall adapter). However, this current must not exceed the maximum charge overcurrent,  $I_{MAX}$ . If an overcurrent condition is detected, the charging is immediately terminated, the GATE pin is pulled to ground and the charge pump turns off. The charging will resume after a 400ms time off ( $C_{TIMER} = 0.1\mu\text{F}$ ).

### Programming the Timer

The programmable timer is used to terminate the charge and sets the minimum ON/OFF time and the overcurrent time-off period. The length of the timer is programmed by

an external capacitor from the TIMER pin to ground. The total charge time is:

$$\text{Time (Hours)} = (3 \text{ Hour}) \cdot (C_{TIMER} / 0.1\mu\text{F})$$

The timer starts when the input voltage (at least 40mV greater than  $V_{BAT}$ ) is applied and the potential at the  $\overline{NTC}/\overline{SHDN}$  pin is between  $0.5 \cdot V_{CC}$  and  $0.875 \cdot V_{CC}$ . After a time-out has occurred, the charging stops and the  $\overline{CHRG}$  pin becomes high impedance.

### $\overline{CHRG}$ Status Output Pin

This open-drain output requires a pull-up resistor and can be used to indicate three charging conditions. When fast charging begins, an N-FET (capable of driving an LED) turns on, pulling this pin to ground. Once the duty cycle at the GATE pin drops below 10%, the N-FET turns off and a 40 $\mu\text{A}$  current source to ground turns on. When a time-out occurs or the input supply is removed, the  $\overline{CHRG}$  pin goes high impedance indicating that the charge cycle has ended. By using two different value resistors, a microprocessor can detect three states from this pin: charging, C/10 and stop charging (see Figure 1).

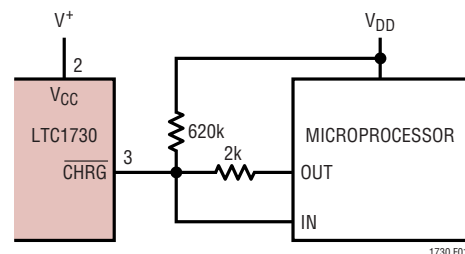

Figure 1. Interfacing with Microprocessor

When the LTC1730 is in charge mode, the  $\overline{CHRG}$  pin is pulled to ground by an internal N-MOSFET. To detect this mode, force the digital output pin, OUT, high and measure the voltage at the  $\overline{CHRG}$  pin. The N-MOSFET will pull the pin low even with a 2k pull-up resistor. Once the charge current drops below 10% of the full scale current (C/10), the N-MOSFET is turned off and a 40 $\mu\text{A}$  current source is connected to the  $\overline{CHRG}$  pin. By forcing the OUT pin to a high impedance state, the current source will pull the pin low through the 620k resistor. When the internal timer has expired, the  $\overline{CHRG}$  pin becomes high impedance and the 620k resistor will pull the pin high to indicate that charging has stopped.



## APPLICATIONS INFORMATION

### End-of-Charge (C/10)

The LTC1730 includes a comparator to monitor the duty cycle at the GATE pin to detect a near end-of-charge condition. When the duty cycle falls below 10%, the comparator trips and turns off the N-MOSFET at the  $\overline{\text{CHRG}}$  pin and switches in a weak ( $40\mu\text{A}$ ) current source to ground. The end-of-charge comparator is disabled in trickle charge mode.

### Internal Pass Transistor

An N-channel MOSFET ( $0.35\Omega$ ) is included in the LTC1730 as the pass transistor. The gate of the MOSFET is controlled by an internal charge pump. The body is connected to ground instead of source terminal. There is no body diode from the BAT pin back to the  $V_{\text{CC}}$  pin; therefore, no blocking diode is required in series with the battery or the input supply. This will not only reduce the cost but also the heat generated when in fast charge mode. An internal thermal shutdown circuit turns off the pass transistor if the die temperature exceeds approximately  $140^\circ\text{C}$  with  $5^\circ\text{C}$  of thermal hysteresis.

### Gate Drive

The pass transistor gate drive consists of a regulated  $10\mu\text{A}$  current source charge pump. A series RC network is required from the GATE pin to the  $V_{\text{CC}}$  pin. When the pass transistor is turned on, the voltage at the  $V_{\text{CC}}$  pin starts slewing down to a voltage equal to  $V_{\text{BAT}}$  plus the voltage drop across the pass transistor and  $R_{\text{SENSE}}$ . The slew rate is equal to  $10\mu\text{A}/\text{C}$ . By ramping the  $V_{\text{CC}}$  pin down slowly, the inrush current is reduced. The resistor in series with the capacitor is required to limit the transient current when the input supply is first applied.

When the charge pump is turned off, a  $40\mu\text{A}$  current source to ground starts pulling the GATE voltage down. Once the pass transistor is off, the voltage at the  $V_{\text{CC}}$  pin begins slewing up with the rate equal to  $40\mu\text{A}/\text{C}$ . With this external capacitor, the voltage at the  $V_{\text{CC}}$  pin is ramping at a controlled manner (Figure 2).

For higher current applications an external power N-MOSFET can be connected in parallel with the internal pass transistor. Because the charge pump output is clamped to 12V

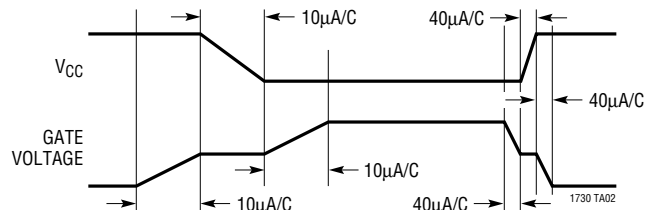

Figure 2. Slew Rate at GATE and  $V_{\text{CC}}$  Pins with the RC Network from GATE to  $V_{\text{CC}}$

above  $V_{\text{BAT}}$ , the external N-MOSFET gate to source breakdown voltage should be rated at 20V or more.

### Battery Temperature Detection

A negative temperature coefficient (NTC) thermistor located close to the battery pack can be used to monitor battery temperature and will not allow charging unless the battery temperature is within an acceptable range. Connect a  $10\text{k}\Omega$  thermistor between ground and the NTC/SHDN pin and a  $4.1\text{k}\Omega$  resistor from the NTC/SHDN pin to  $V_{\text{CC}}$ . If the temperature rises to  $50^\circ\text{C}$ , the resistance of the thermistor will be approximately  $4.1\text{k}\Omega$  (Dale NTHS-1206N02) and the LTC1730 will go into a hold mode. For cold temperatures, the threshold of the hold mode is at  $0^\circ\text{C}$  ( $R_{\text{NTC}} \approx 28\text{k}\Omega$ ). The pass transistor turns off and the timer is frozen at hold mode while the output status at the  $\overline{\text{CHRG}}$  pin remains the same. The charge cycle begins or resumes once the temperature is within the acceptable range.

### Thermal Considerations

The power handling capability is limited by the maximum rated junction temperature ( $125^\circ\text{C}$ ) and the amount of PC board copper used as a heat sink. The power dissipated by the device consists of two components:

1. Input supply current multiplied by the input voltage
2. The voltage drop across the switch (SENSE pin to BAT pin) multiplied by the charge current

The LTC1730 has internal thermal shutdown designed to protect the IC from overtemperature conditions. For continuous charging in the fast charge mode, the maximum junction temperature must not be exceeded. It is important to give careful consideration to all sources of thermal resistance from junction to ambient. Additional heat sources mounted nearby must also be considered.

## APPLICATIONS INFORMATION

Surface mount packages rely primarily on the copper leads (pins) to conduct the heat from the package to the surrounding PC board copper which is acting as a heat sink. The ground pin is especially important for conducting heat as well as providing an electrical connection. Use generous amounts of copper around the ground pin and also consider feedthrough vias (plated through holes) to backside or inner copper layers to maximize power dissipation.

Table 1 lists the thermal resistance for the SO-8 package. Measured values of thermal resistance for several different board sizes and copper areas are listed. All measurements were taken in still air on 0.062" FR-4 board with one ounce copper.

### Calculating Junction Temperature

Example: Find the maximum junction temperature for a battery voltage of 4V ( $V_{CC}$  will collapse to approximately  $V_{BAT}$  in the fast charge mode), charge current of 1A and a maximum ambient temperature of 75°C.

The power dissipated by the IC is:

$$\begin{aligned} P &= (I_{BAT} \cdot I_{BAT} \cdot R_{DS(ON)}) + (V_{CC} \cdot I_{CC}) \\ &= (1A \cdot 1A \cdot 0.35\Omega) + (4V \cdot 1mA) \\ &= 0.35 + 0.004 \\ &= 0.354W \end{aligned}$$

The SO-8 package for the LTC1730 features a special lead frame with a lower thermal resistance and higher allowable power dissipation. The junction-to-ambient thermal resistance of this package when soldered to a PC board is approximately 80°C/W depending on the copper area. So the junction temperature rise above ambient will be approximately:

$$(0.354W)(80^\circ\text{C/W}) = 28.3^\circ\text{C}$$

The maximum junction temperature is equal to the maximum junction temperature rise above ambient plus the maximum ambient temperature or:

$$T_{JMAX} = 75^\circ\text{C} + 28.3^\circ\text{C} = 103.3^\circ\text{C}$$

**Table 1. SO-8 Package Thermal Resistance**

COPPER AREA		TOTAL BOARD AREA	THERMAL RESISTANCE (JUNCTION-TO-AMBIENT)
TOPSIDE	BACKSIDE		
2500mm <sup>2</sup>	2500mm <sup>2</sup>	2500mm <sup>2</sup>	80°C/W
1000mm <sup>2</sup>	2500mm <sup>2</sup>	2500mm <sup>2</sup>	80°C/W
250mm <sup>2</sup>	2500mm <sup>2</sup>	2500mm <sup>2</sup>	85°C/W

\*Device is mounted on top side.

### Output Voltage Selection (LTC1730EGN-4)

The float voltage at the BAT pin can be selected by the SEL pin. Shorting the SEL pin to ground will set the float voltage to 4.1V, while connecting it to  $V_{CC}$  sets it to 4.2V. This feature allows the charger to be used with different types of Li-Ion cells.

### ACPR Output Pin (LTC1730EGN-4)

When the input voltage is 40mV higher than the voltage at the BAT pin, the  $\overline{\text{ACPR}}$  pin is pulled low to ground to indicate that the input supply (wall adapter) is applied. After the input supply is removed, this pin becomes high impedance. An internal 80ms delay prevents the LTC1730 from turning off if the voltage at the  $V_{CC}$  pin rings and gets too close to  $V_{BAT}$  because of the parasitic inductance.

### FAULT Output Pin (LTC1730EGN-4)

The  $\overline{\text{FAULT}}$  pin is pulled to ground when either one of the following conditions is detected:

1. The voltage at the NTC/ $\overline{\text{SHDN}}$  pin is out of the operation range. With a 10k negative temperature coefficient thermistor placed near the battery pack, this pin indicates that the temperature of the pack is either too cold or too hot and the charger is suspended. Once the temperature is back to the operational range, the  $\overline{\text{FAULT}}$  pin becomes high impedance and the charging resumes.
2. The voltage at the BAT pin stays below 2.45V for 1/4 of the programmed charge time. If  $V_{BAT}$  remains low even with 35mA of trickle charge current for 1/4 of the total

## APPLICATIONS INFORMATION

charge time, the battery is considered defective. The charger turns off and the  $\overline{\text{FAULT}}$  pin is pulled low. This pin will stay low until the LTC1730 is reset by either removing the input power supply or momentarily

shutting down the charger. After reset, the charger is back in the charge mode and the  $\overline{\text{FAULT}}$  pin becomes high impedance again.

## PACKAGE DESCRIPTION

### GN Package 16-Lead Plastic SSOP (Narrow .150 Inch) (Reference LTC DWG # 05-08-1641)

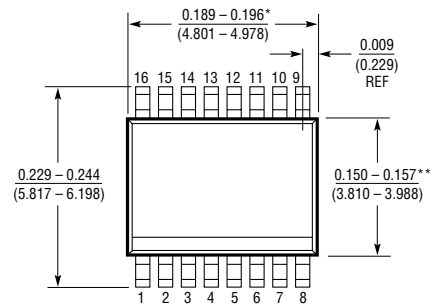
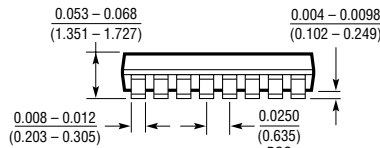
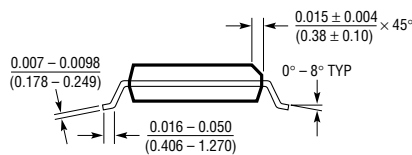

\* DIMENSION DOES NOT INCLUDE MOLD FLASH. MOLD FLASH SHALL NOT EXCEED 0.006" (0.152mm) PER SIDE

\*\* DIMENSION DOES NOT INCLUDE INTERLEAD FLASH. INTERLEAD FLASH SHALL NOT EXCEED 0.010" (0.254mm) PER SIDE

GN16 (SSOP) 1098

### S8 Package 8-Lead Plastic Small Outline (Narrow .150 Inch) (Reference LTC DWG # 05-08-1610)

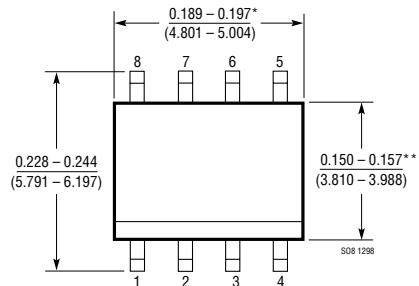
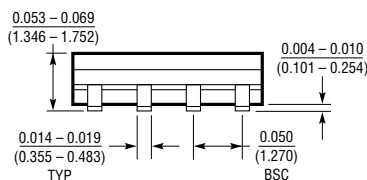
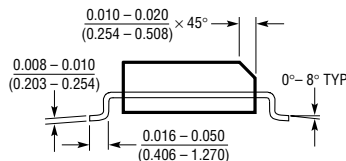

\* DIMENSION DOES NOT INCLUDE MOLD FLASH. MOLD FLASH SHALL NOT EXCEED 0.006" (0.152mm) PER SIDE

\*\* DIMENSION DOES NOT INCLUDE INTERLEAD FLASH. INTERLEAD FLASH SHALL NOT EXCEED 0.010" (0.254mm) PER SIDE