



Datasheet

Discone One

Part No:
DCN.01.035111

Description:

400-6000MHz Wideband Discone Omnidirectional 5G/4G Antenna
with 300mm TGC-200 & SMA(M)ST

Features:

High efficiency antenna covering 400-6000MHz
Covers all worldwide cellular 5G/4G Cat-M/ LTE-M and NB-IoT bands
Permanent/Wall/Pole mount antenna
IP67 rated waterproof enclosure
Cable: 300mm TGC-200
Connector: SMA(M)ST
Dimensions: 200*200*203mm
RoHS & Reach Compliant



1. Introduction	3
2. Specifications	4
3. Antenna Characteristics	7
4. Radiation Patterns	10
5. Mechanical Drawing	27
6. Installation Guidelines	28
7. Packaging	33
<hr/>	
Changelog	34

Taoglas makes no warranties based on the accuracy or completeness of the contents of this document and reserves the right to make changes to specifications and product descriptions at any time without notice. Taoglas reserves all rights to this document and the information contained herein. Reproduction, use or disclosure to third parties without express permission is strictly prohibited.



1. Introduction



The Taoglas Discone One DCN.01 is a wideband, omnidirectional antenna that has been expertly engineered to cover all worldwide 5G and 4G bands, including all sub-6GHz deployments across the 400MHz to 6000MHz spectrum. It is designed primarily for use with 5G/4G modules and devices that require high efficiency – the Discone One boasts over 50% across the entire spectrum. With a high peak gain of up to 6.6dBi, it delivers best-in-class throughput on all major cellular bands worldwide.

It is innovatively designed to deliver reliability on new, dedicated mission-critical communications bands between 400-500MHz. Additionally, it covers extended 4G, band 71, and all 5G NR Sub 6GHz bands while also covering 3G/2G bands to allow for fallback when 5G/4G isn't available – keeping applications and devices connected when it's most needed.

Typical applications include:

- Mission-Critical Smart Grid Applications
- Remote Asset and Pipeline Monitoring
- Next Generation OEM Automotive Connectivity
- First Responder and Emergency Services
- Military and Defense Applications

The heavy-duty, fully IP67 rated external ABS enclosure allows this antenna to be mounted in harsh external environments where a robust, waterproof antenna is required. With high peak gains and high efficiencies over frequencies from 400-6000MHz, the Discone One is a fantastic solution for wideband cellular applications.

5G applications demand high-speed data uplink and downlink. High efficiency and high gain antennas are necessary to achieve the required signal-to-noise ratio and throughput required to solve these challenges. Low-loss TGC-200 cable is used to keep efficiency high over long cable lengths. The cable length and connector types are customizable. Contact your regional Taoglas customer support team for more information.

2. Specifications

Electrical									
Band	Frequency (MHz)	Condition	Efficiency (%)	Average Gain (dB)	Peak Gain (dBi)	Impedance	Max Input Power	Polarization	Radiation Pattern
4G/3G Band 31,87,88,126	400~480	Free Space	65.9	-1.8	1.2	50 Ω	20W	Linear	Omni-Directional
		GND Plane	61.4	-2.1	0.6				
5G NR/4G Band 71	617~698	Free Space	62.9	-2	1.8				
		GND Plane	62.1	-2.1	1.6				
4G/3G Band 12,13,14,17,28,29	698~806	Free Space	59.1	-2.3	0.7				
		GND Plane	65.1	-1.9	4.7				
4G/3G/NB-IoT/Cat M Band 5,8,18,19,20,26,27	824~960	Free Space	62.2	-2.1	3.4				
		GND Plane	67.2	-1.7	4.9				
5G NR/4G Band 21,32,74,75,76	1427~1518	Free Space	72.6	-1.4	3.2				
		GND Plane	63.7	-2	5				
4G/3G Band 1,2,3,4,9,23,25,35,39,66	1710~2200	Free Space	74.3	-1.3	3.9				
		GND Plane	75.2	-1.2	6.6				
4G/3G Band 7,30,38,40,41	2300~2690	Free Space	75.1	-1.2	4.7				
		GND Plane	73.4	-1.4	4.1				
5G NR/4G Band 22,42,48,77,78,79	3300~5000	Free Space	78.1	-1.1	4.6				
		GND Plane	75.4	-1.2	4.8				
LTE5200/ Wi-Fi 5800	5150~5925	Free Space	58.6	-2.3	4.7				
		GND Plane	56.9	-2.5	6.5				

*GND Plane size: 300x300mm

Mechanical	
Height	203mm
Planar Dimension	200mm * 200mm
Casing	ABS
Cable	300mm TGC200 – Fully Customizable
Connector	SMA(M) - Plug – Fully Customizable
Sealant	Rubber Stopper
Thread Size	M22
Bracket Dimensions	140*190*119mm
Weight	550 g (Not Including Packaging)
Environmental	
Protection	IP67
Temperature Range	-40°C to 85°C
Humidity	Non-condensing 65°C 95% RH
Cable Pull	TGC200 - 9Kgf

5G/4G Bands			
Band Number	5GNR / FR1 / LTE / LTE-Advanced / WCDMA / HSPA / HSPA+ / TD-SCDMA		
	Uplink	Downlink	Covered
1	UL: 1920 to 1980	DL: 2110 to 2170	✓
2	UL: 1850 to 1910	DL: 1930 to 1990	✓
3	UL: 1710 to 1785	DL: 1805 to 1880	✓
4	UL: 1710 to 1755	DL: 2110 to 2155	✓
5	UL: 824 to 849	DL: 869 to 894	✓
7	UL: 2500 to 2570	DL: 2620 to 2690	✓
8	UL: 880 to 915	DL: 925 to 960	✓
9	UL: 1749.9 to 1784.9	DL: 1844.9 to 1879.9	✓
11	UL: 1427.9 to 1447.9	DL: 1475.9 to 1495.9	✓
12	UL: 699 to 716	DL: 729 to 746	✓
13	UL: 777 to 787	DL: 746 to 756	✓
14	UL: 788 to 798	DL: 758 to 768	✓
17	UL: 704 to 716	DL: 734 to 746	✓
18	UL: 815 to 830	DL: 860 to 875	✓
19	UL: 830 to 845	DL: 875 to 890	✓
20	UL: 832 to 862	DL: 791 to 821	✓
21	UL: 1447.9 to 1462.9	DL: 1495.9 to 1510.9	✓
22	UL: 3410 to 3490	DL: 3510 to 3590	✓
23	UL: 2000 to 2020	DL: 2180 to 2200	✓
24	UL: 1625.5 to 1660.5	DL: 1525 to 1559	✓
25	UL: 1850 to 1915	DL: 1930 to 1995	✓
26	UL: 814 to 849	DL: 859 to 894	✓
27	UL: 807 to 824	DL: 852 to 869	✓
28	UL: 703 to 748	DL: 758 to 803	✓
29	UL: -	DL: 717 to 728	✓
30	UL: 2305 to 2315	DL: 2350 to 2360	✓
31	UL: 452.5 to 457.5	DL: 462.5 to 467.5	✓
32	UL: -	DL: 1452 – 1496	✓
35		1850 to 1910	✓
38		2570 to 2620	✓
39		1880 to 1920	✓
40		2300 to 2400	✓
41		2496 to 2690	✓
42		3400 to 3600	✓
43		3600 to 3800	✓
48		3550 to 3700	✓
66	UL: 1710-1780	DL: 2110-2200	✓
71		617 to 698	✓
74/75/76		1427 to 1518	✓
77		3300 to 4200	✓
78		3300 to 3800	✓
79		4400 to 5000	✓
85		698 to 746	✓
87/88		410 to 427	✓

3. Antenna Characteristics

3.1 Return Loss

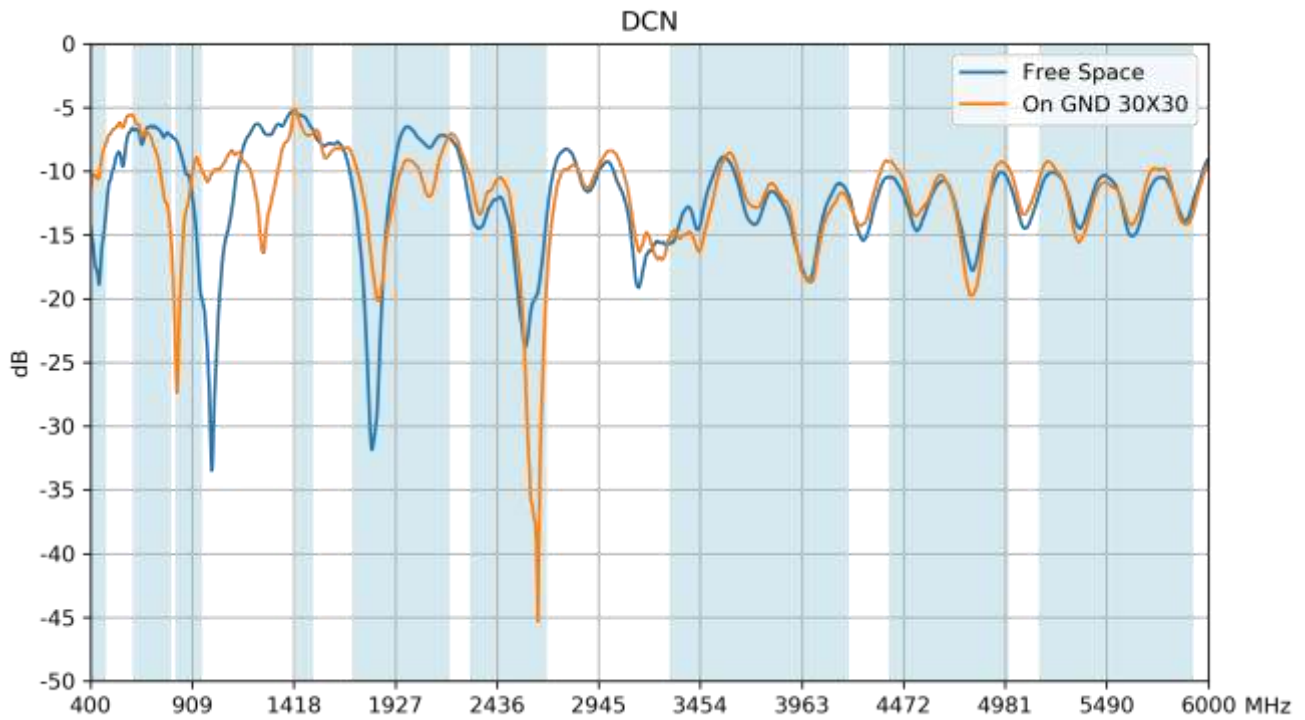

3.2 VSWR

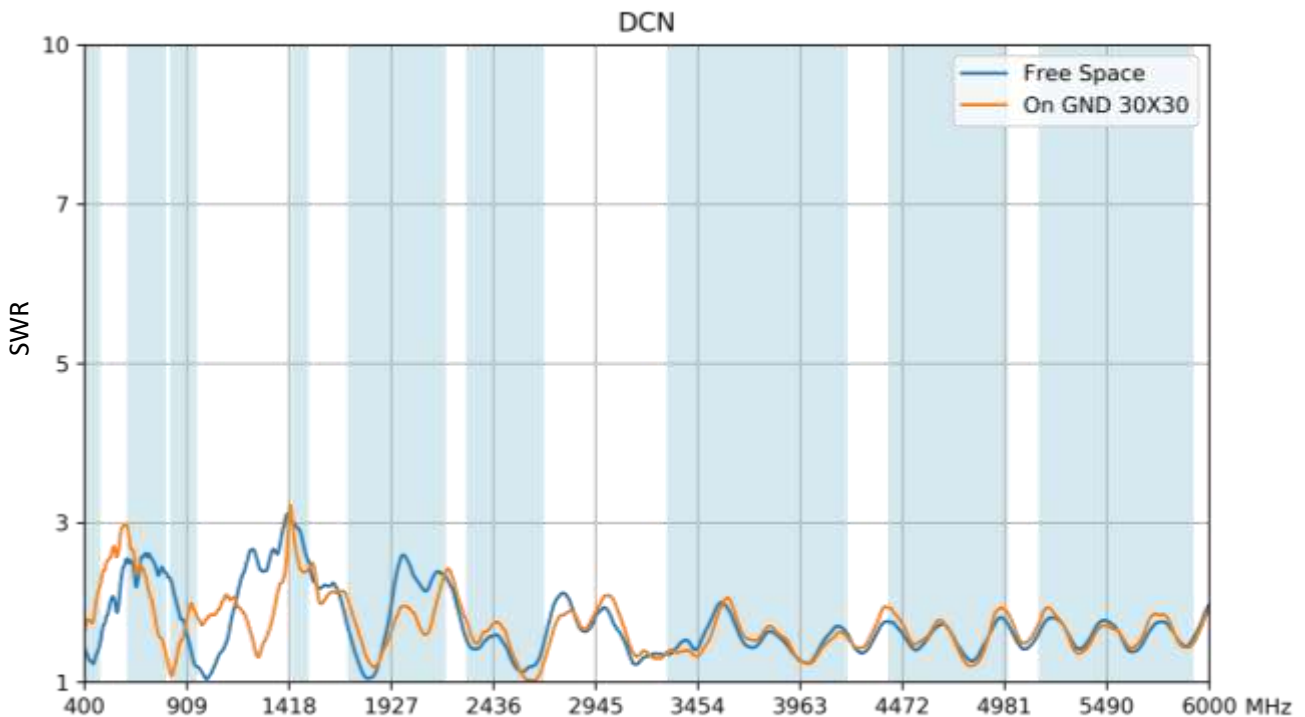

3.3 Efficiency

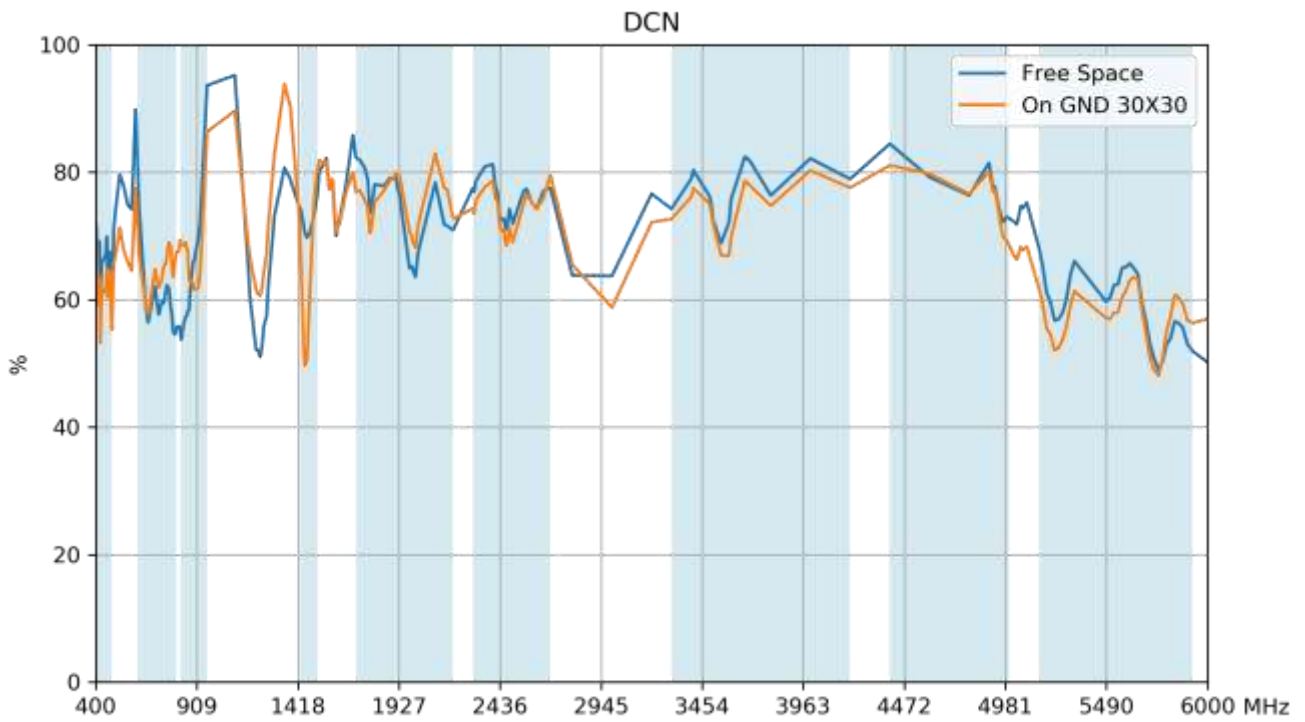

3.4 Average Gain

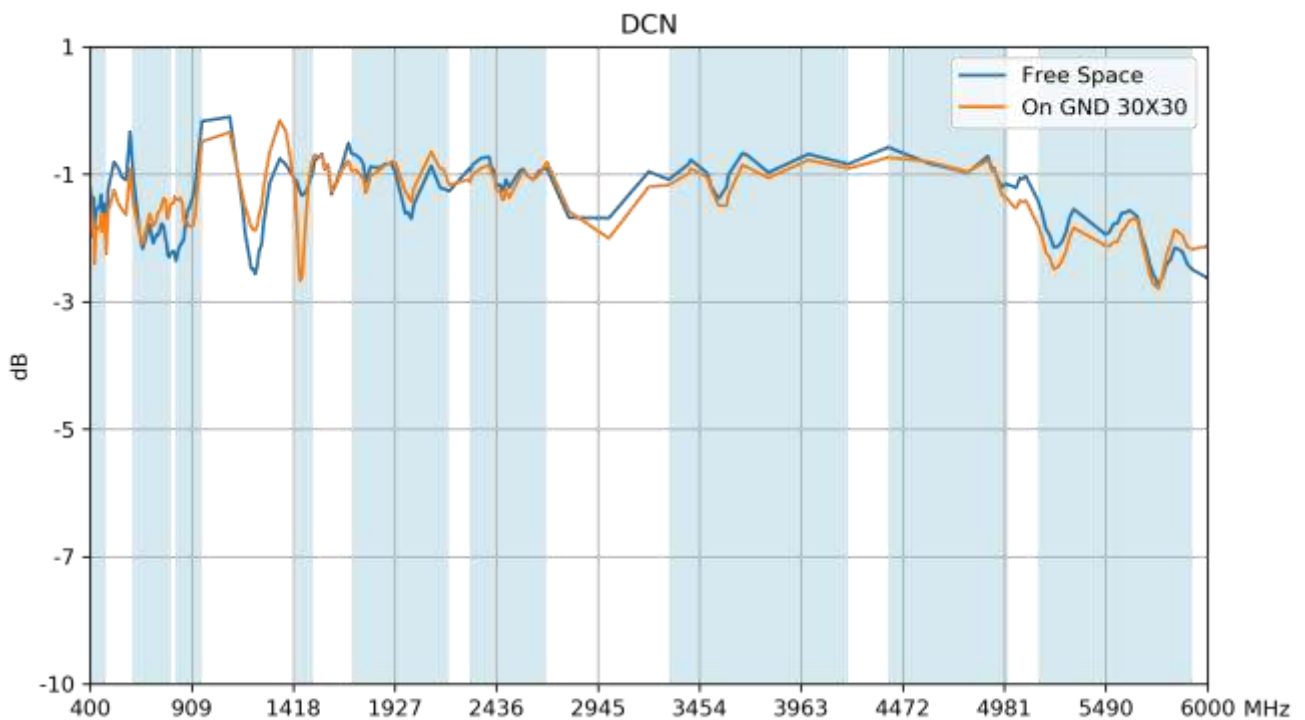

3.5 Peak Gain

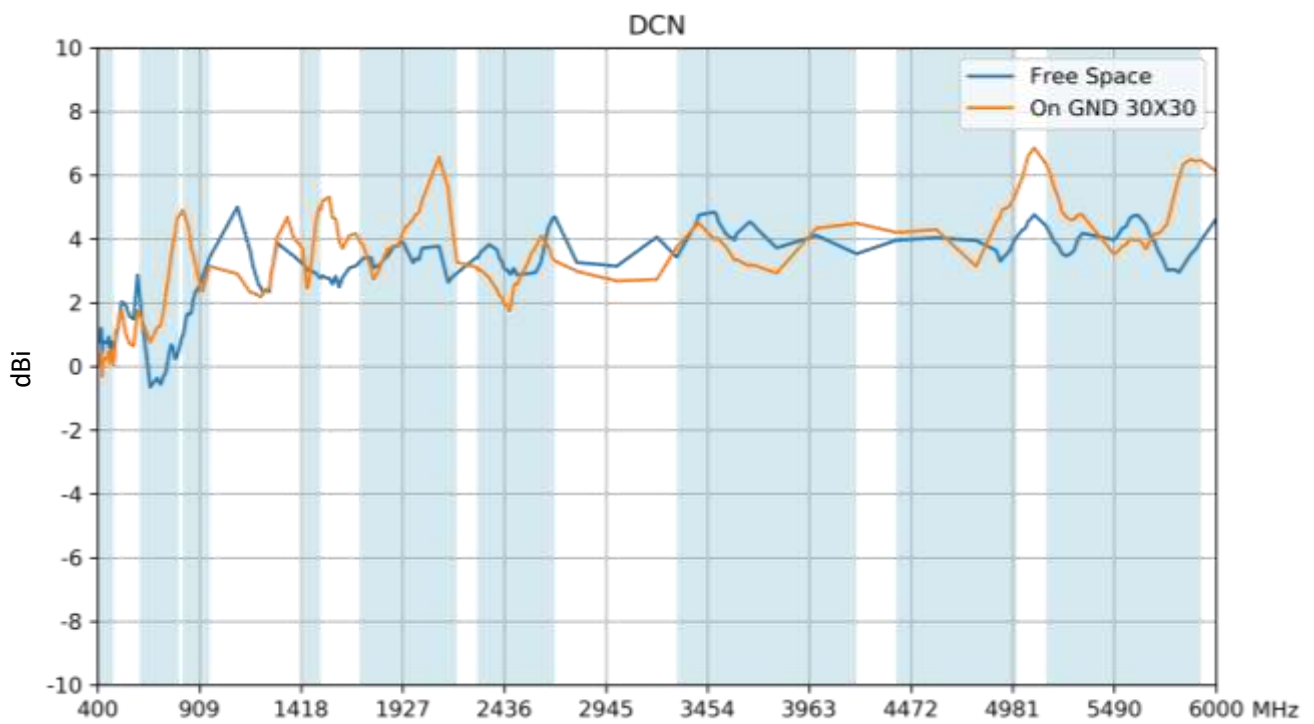

4. Radiation Patterns

4.1 Test Setup on 300x300mm Ground Plane

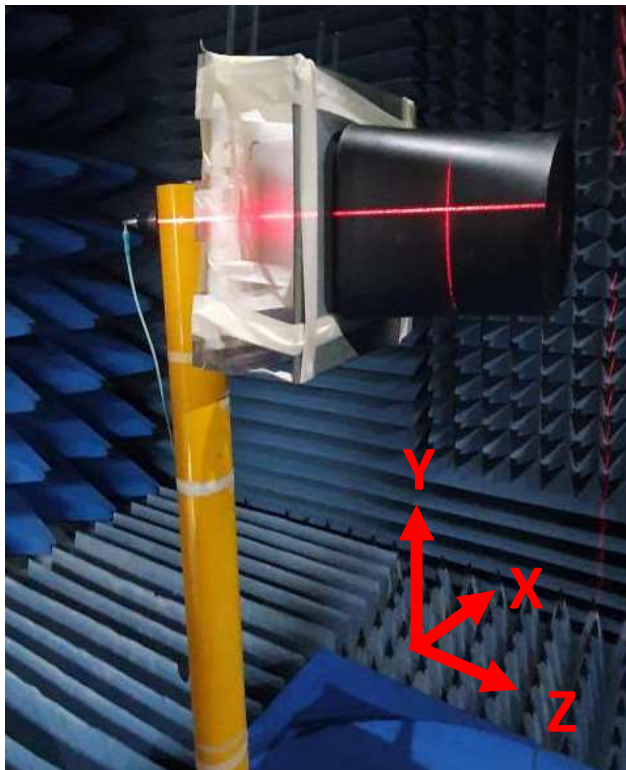

4.2 300*300mm Ground Plane 3D and 2D Radiation Patterns

450MHz

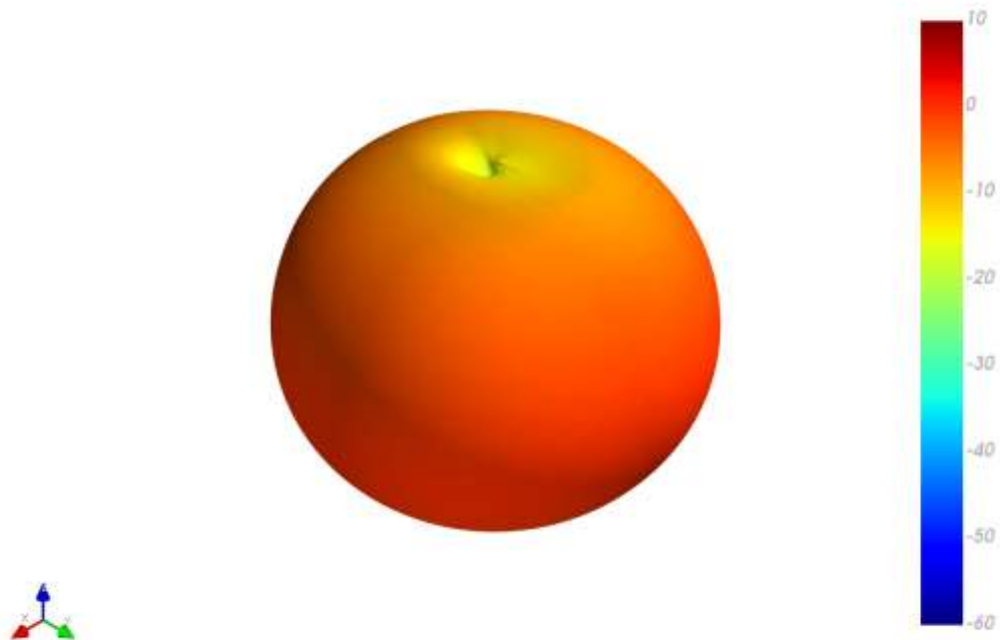

XY Plane

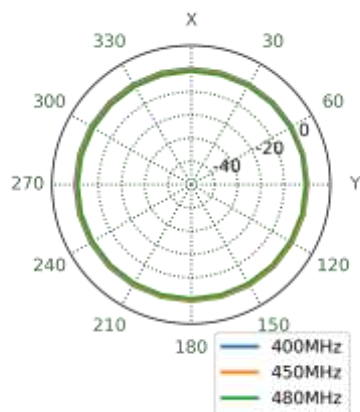

XZ Plane

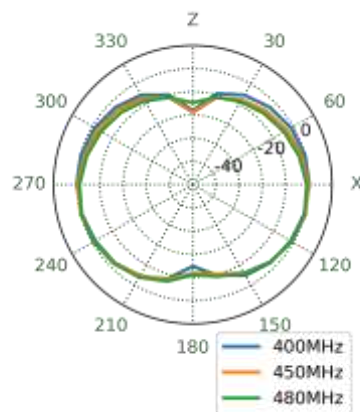

YZ Plane

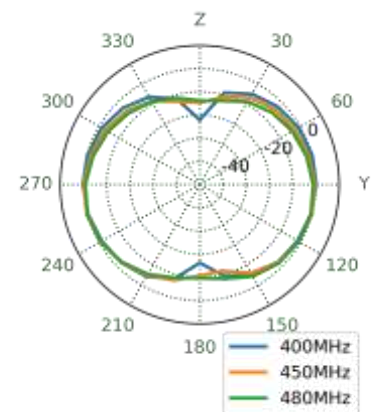

663MHz

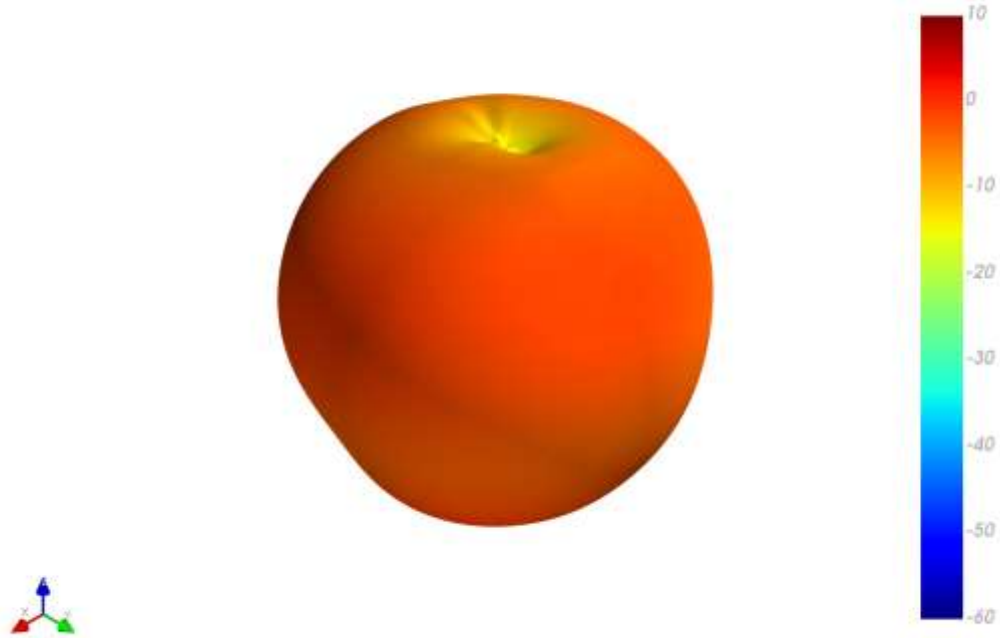

XY Plane

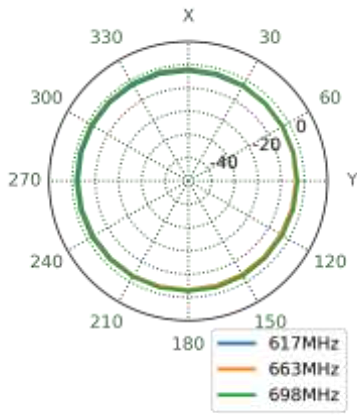

XZ Plane

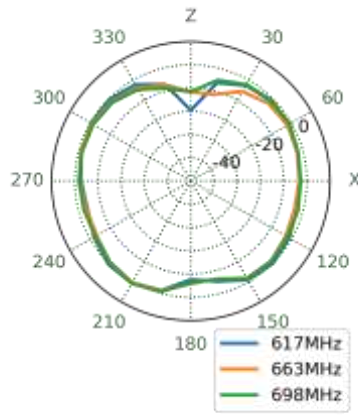

YZ Plane

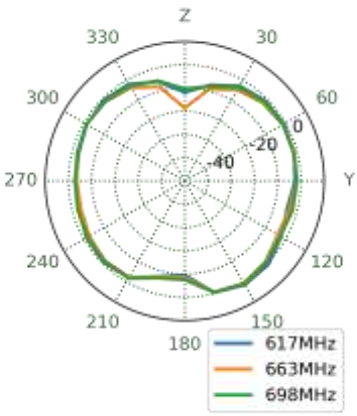

751MHz

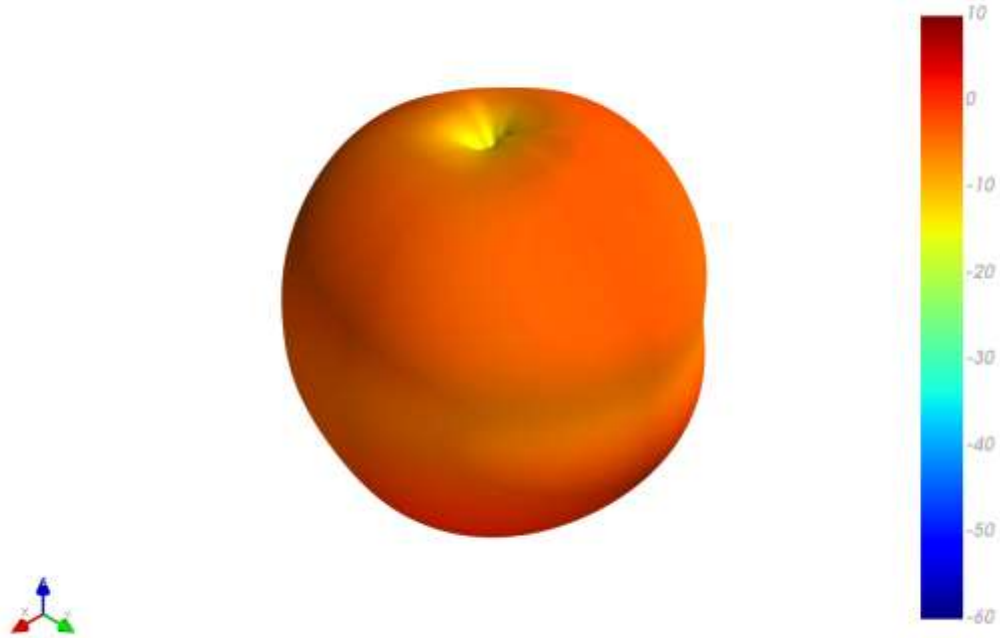

XY Plane

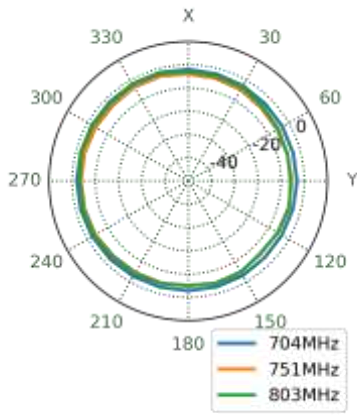

XZ Plane

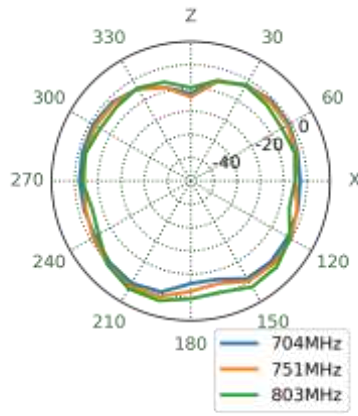

YZ Plane

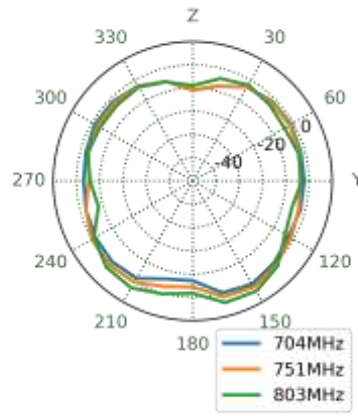

860MHz

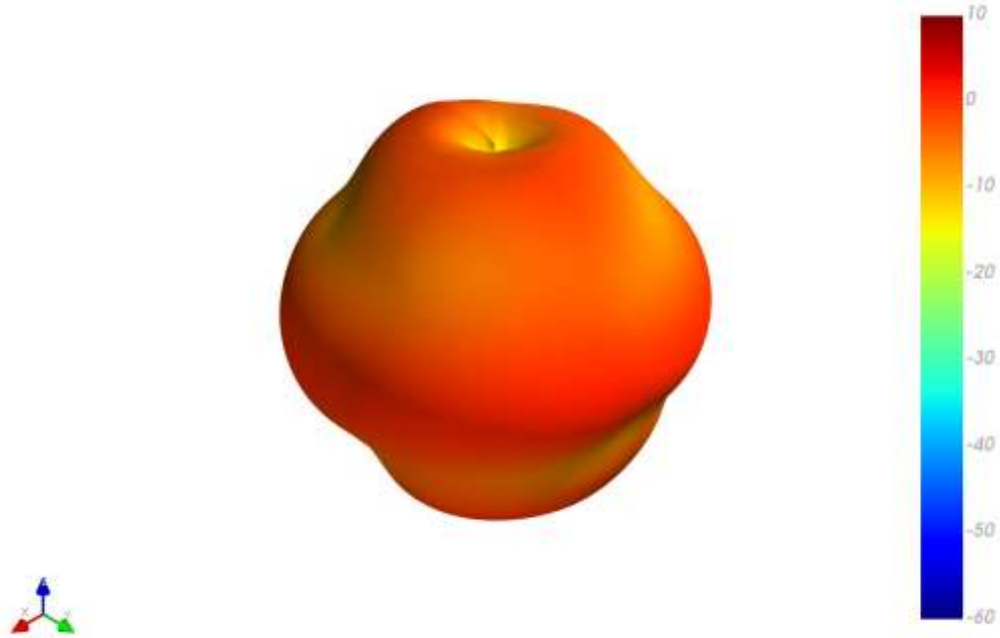

XY Plane

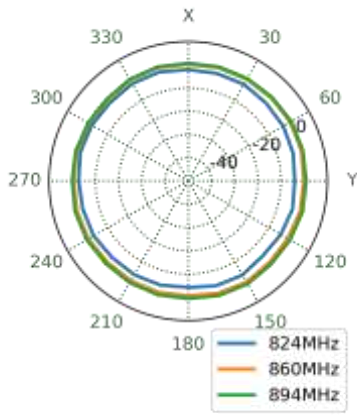

XZ Plane

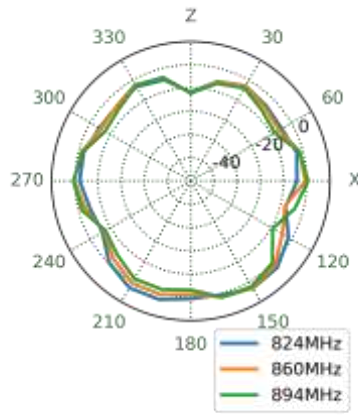

YZ Plane

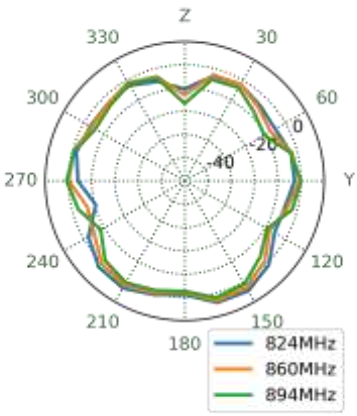

915MHz

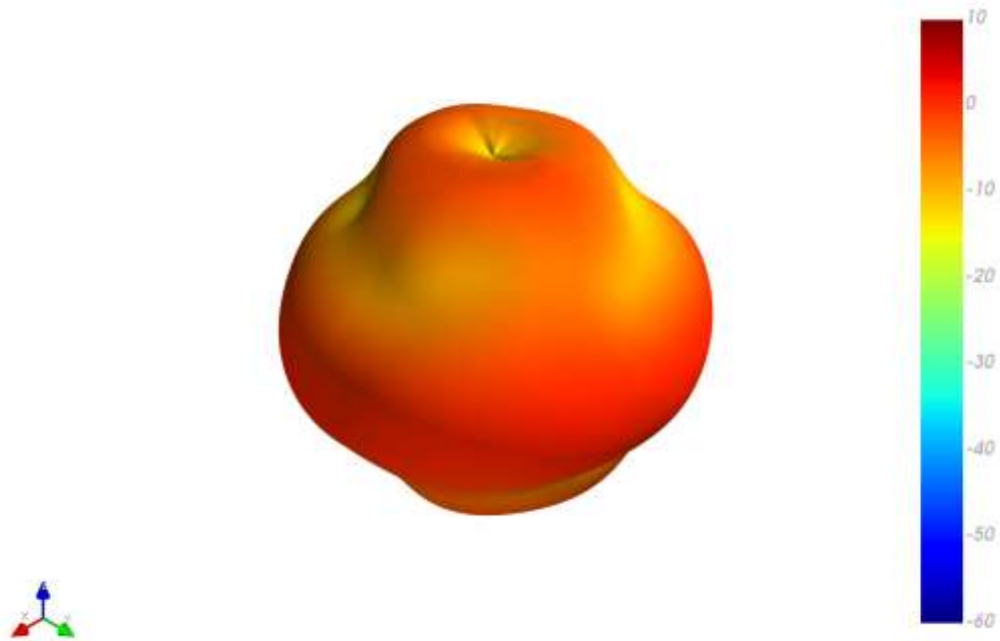

XY Plane

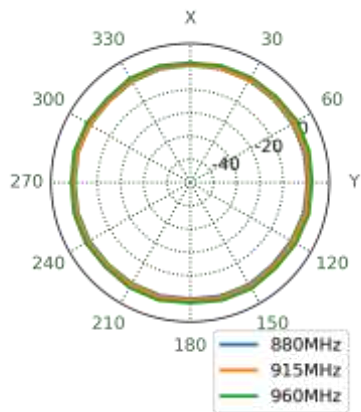

XZ Plane

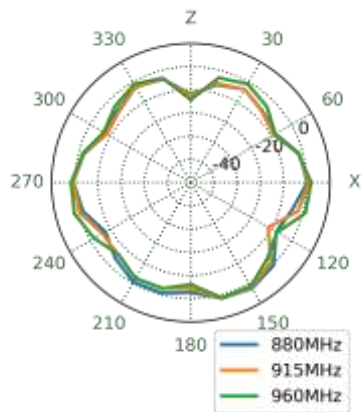

YZ Plane

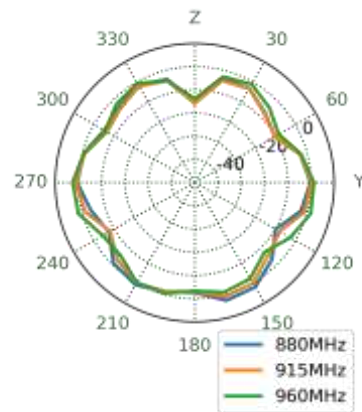

1475MHz

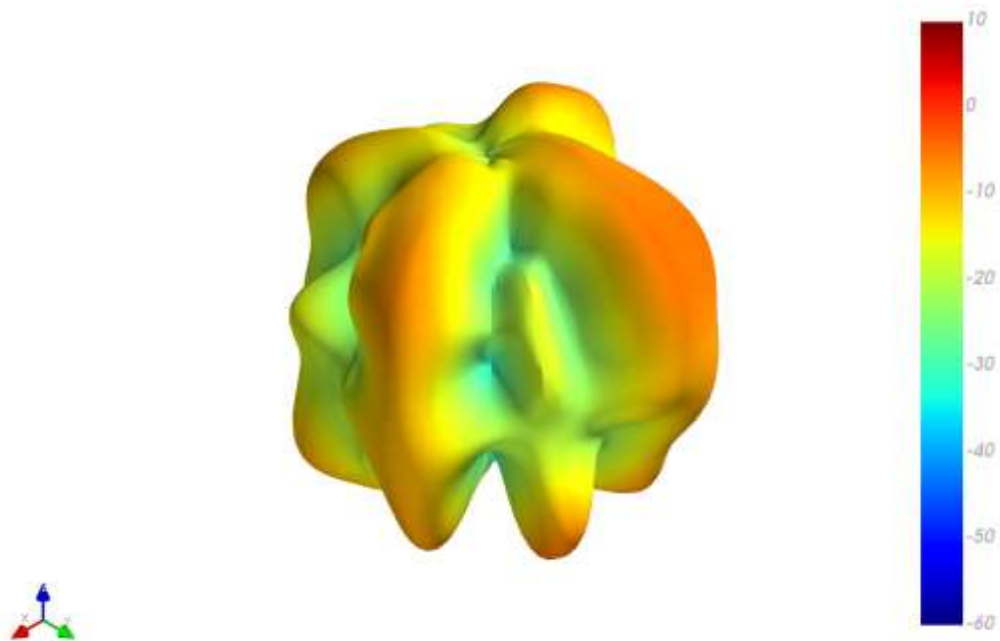

XY Plane

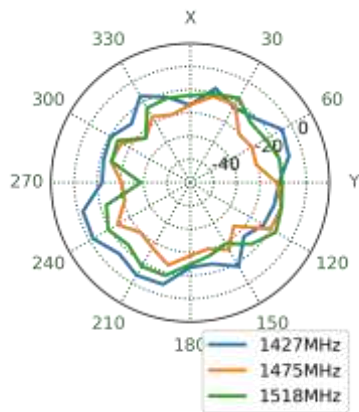

XZ Plane

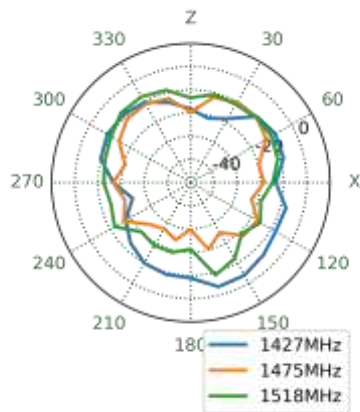

YZ Plane

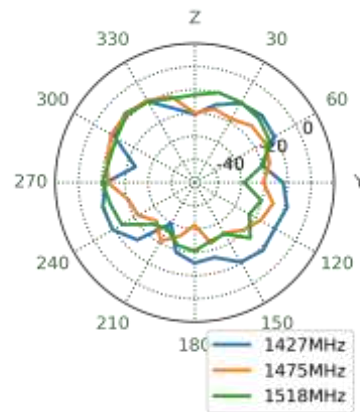

1770MHz

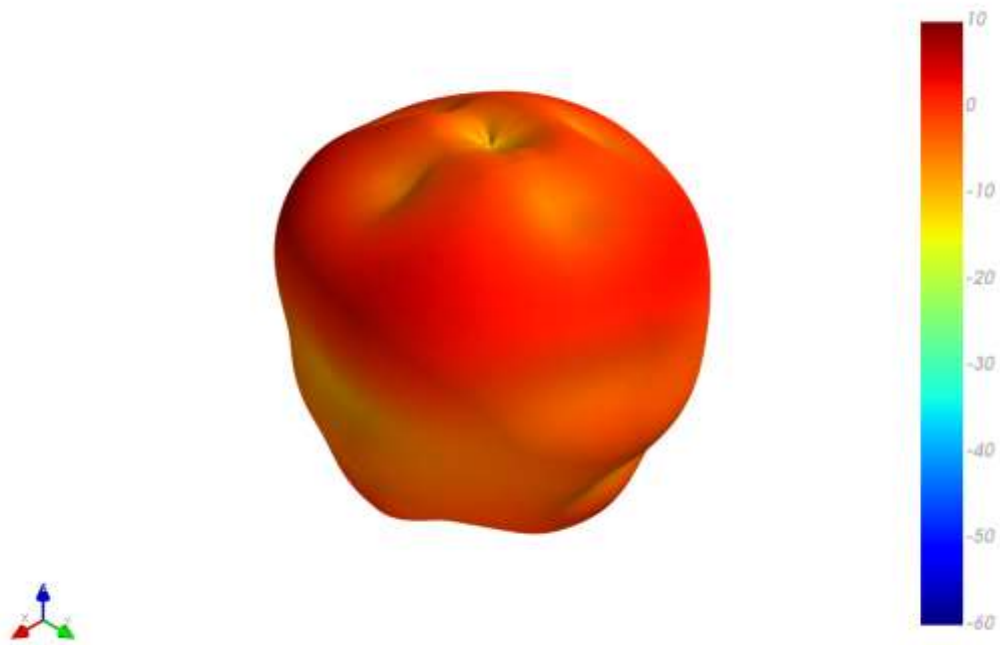

XY Plane

XZ Plane

YZ Plane

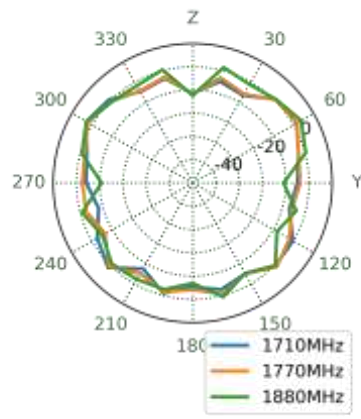
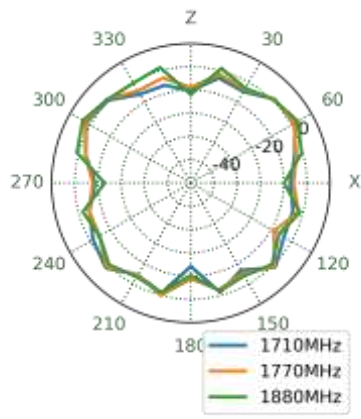
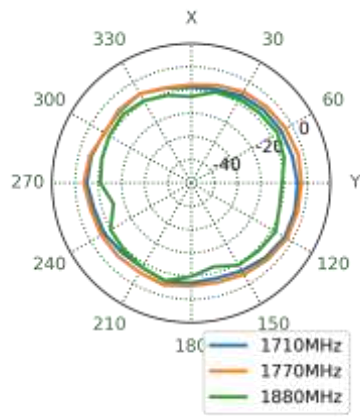

1910MHz

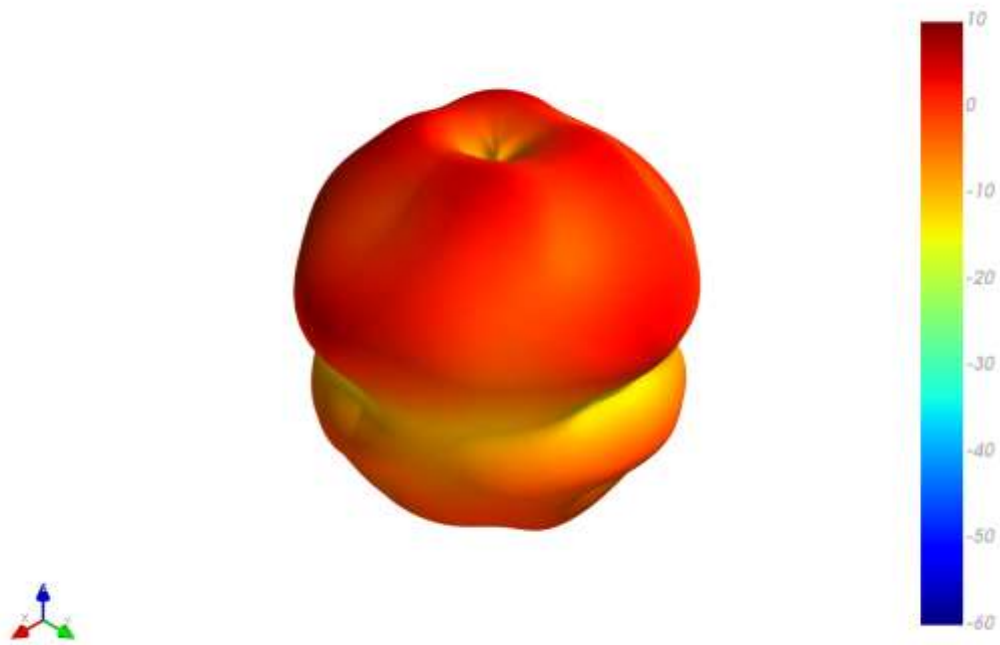

XY Plane

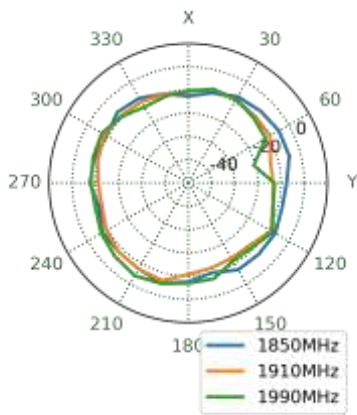

XZ Plane

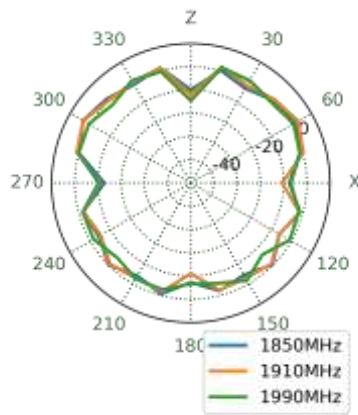

YZ Plane

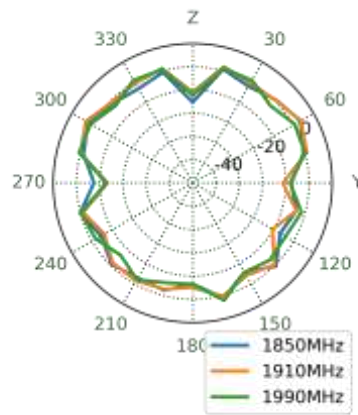

2110MHz

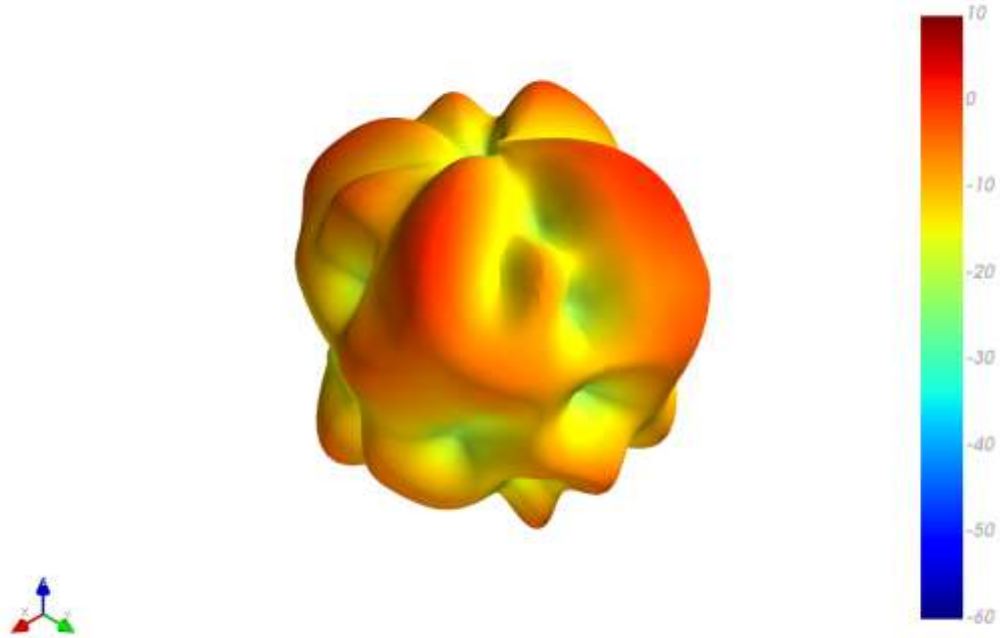

XY Plane

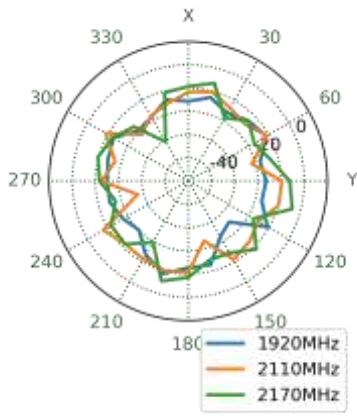

XZ Plane

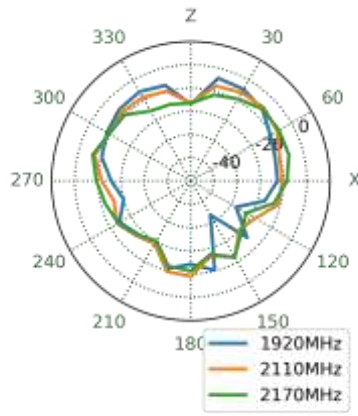

YZ Plane

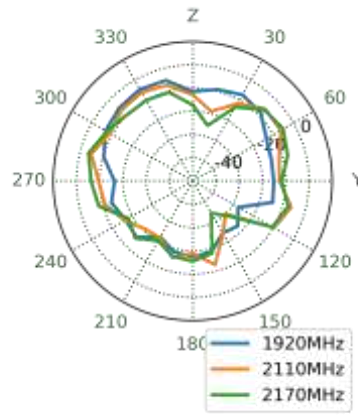

2570MHz

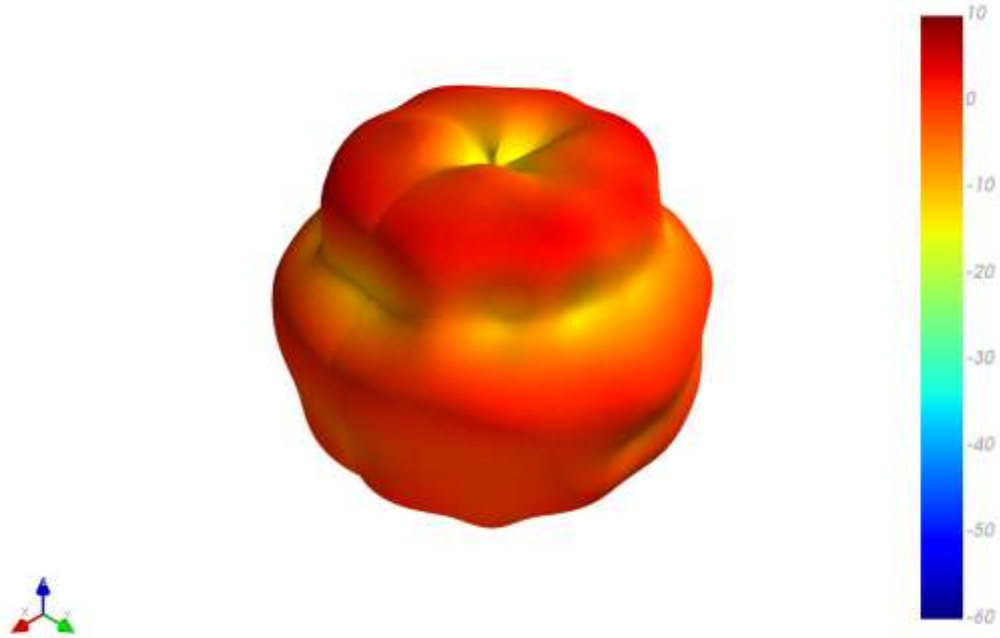

XY Plane

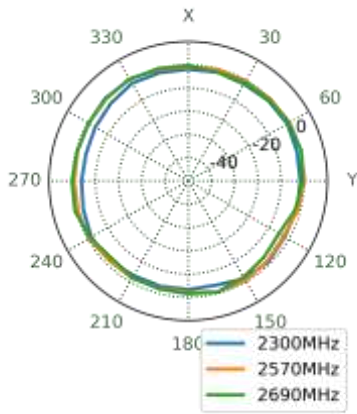

XZ Plane

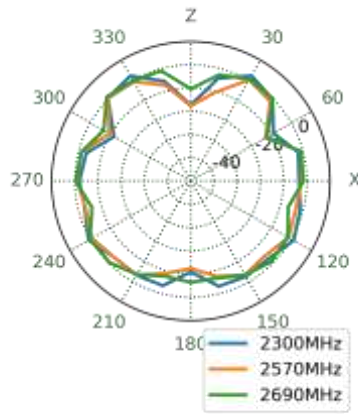

YZ Plane

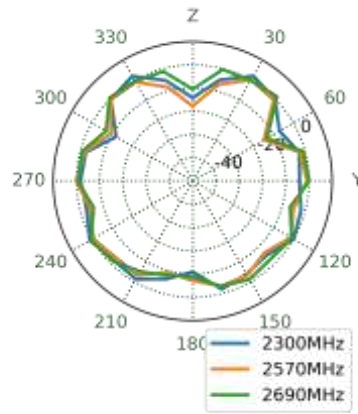

3400MHz

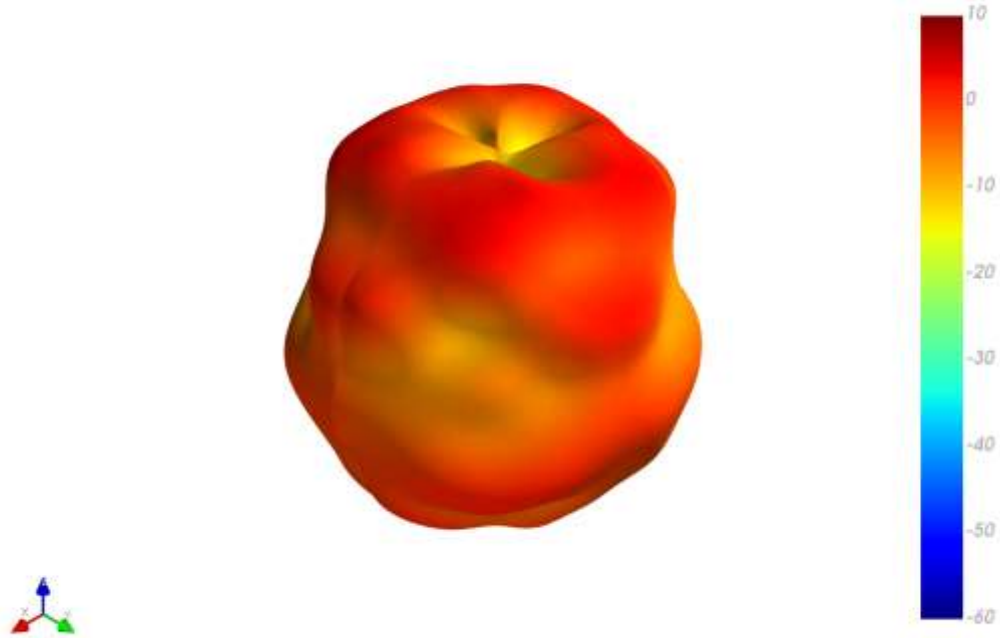

XY Plane

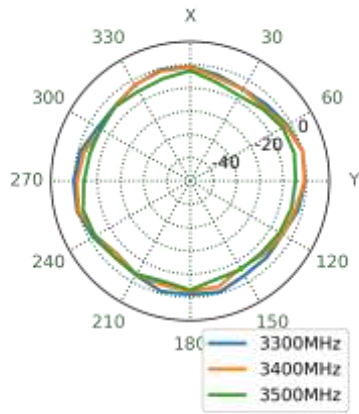

XZ Plane

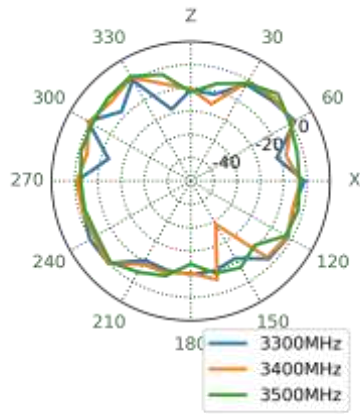

YZ Plane

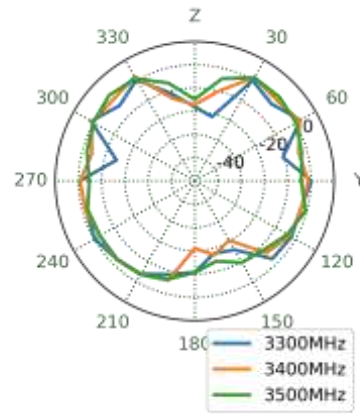

3700MHz

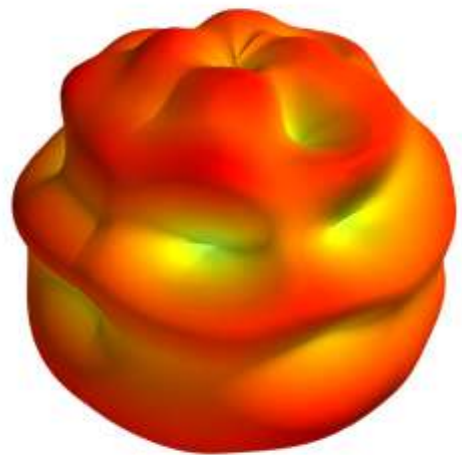

XY Plane

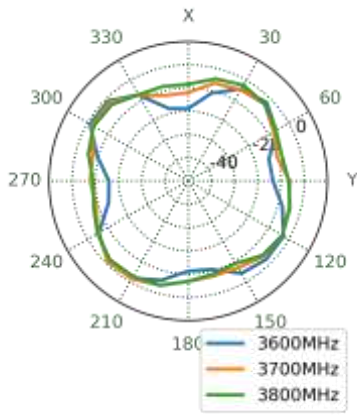

XZ Plane

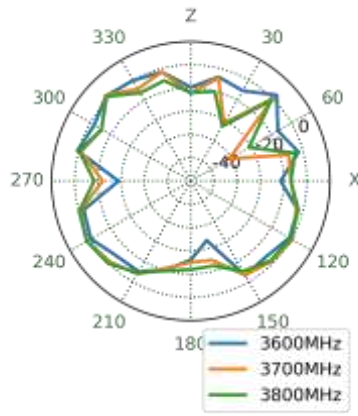

YZ Plane

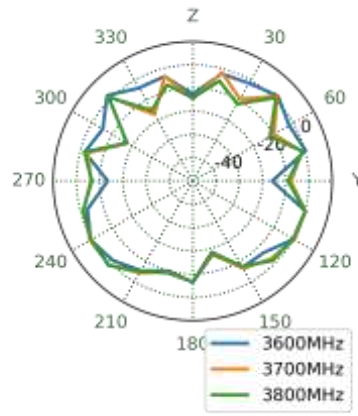

4000MHz

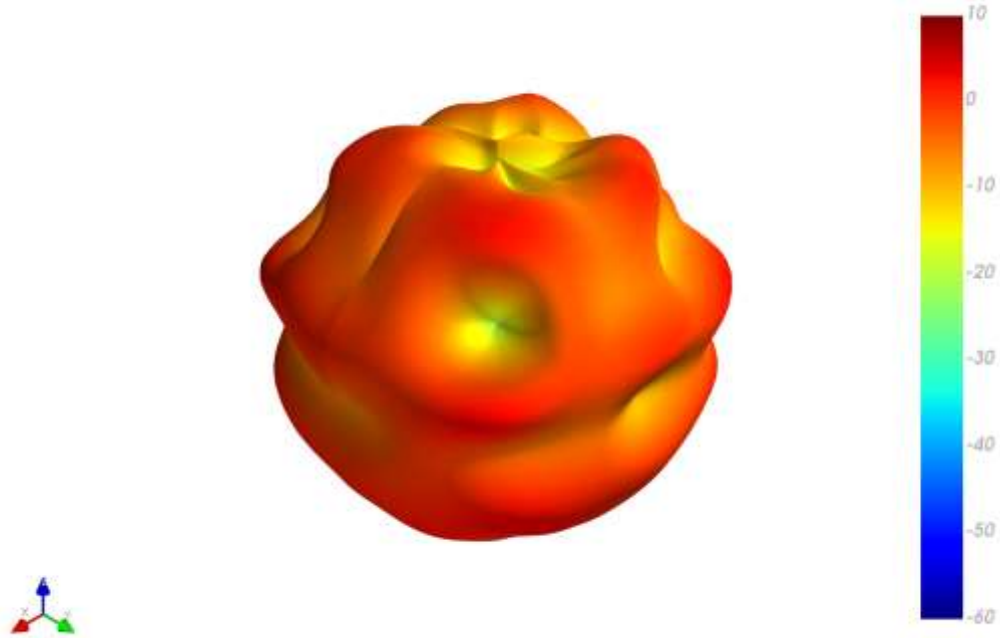

XY Plane

XZ Plane

YZ Plane

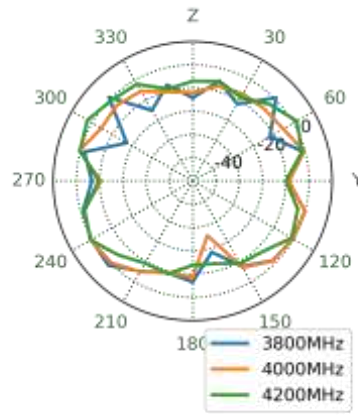
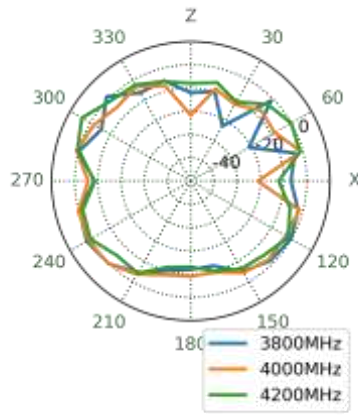
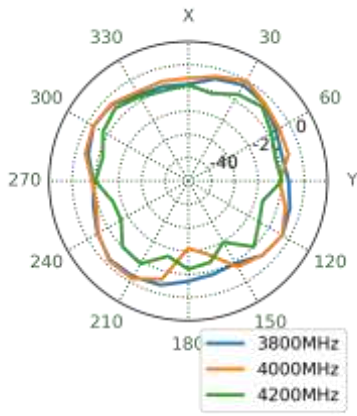

4400MHz

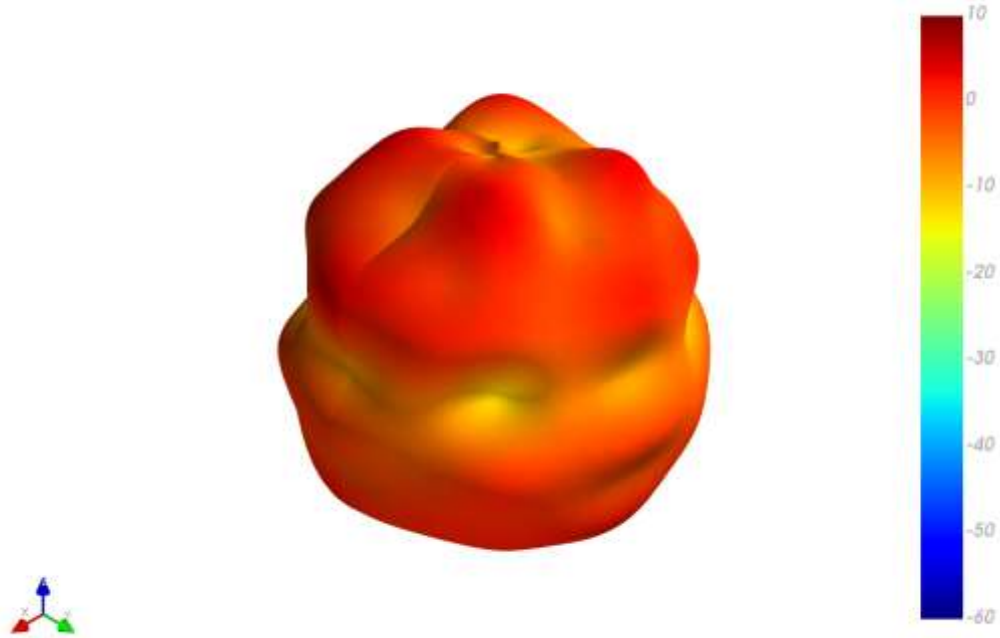

XY Plane

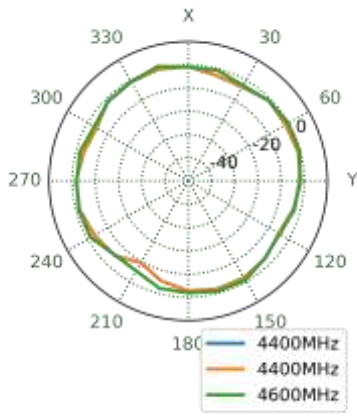

XZ Plane

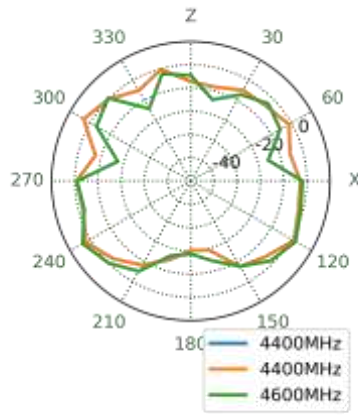

YZ Plane

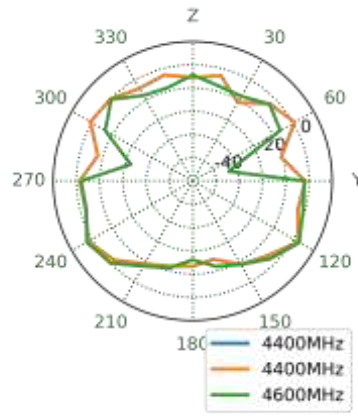

4800MHz

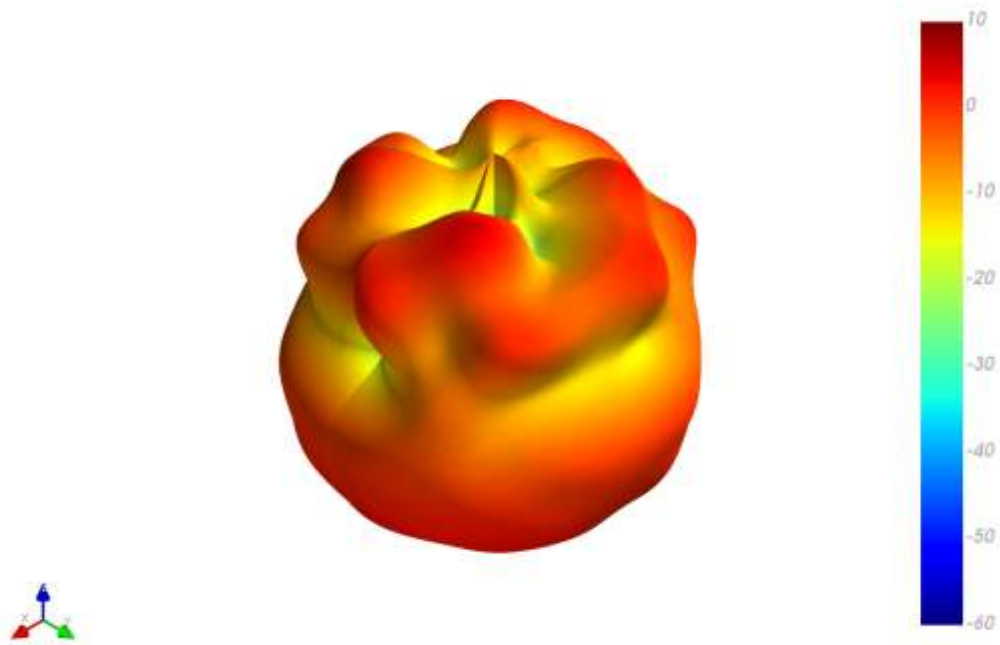

XY Plane

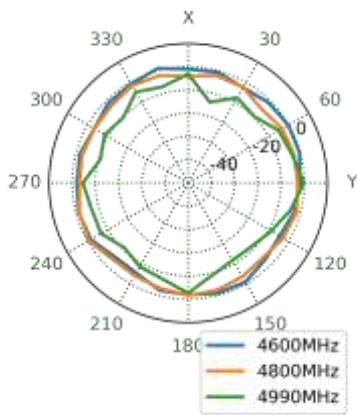

XZ Plane

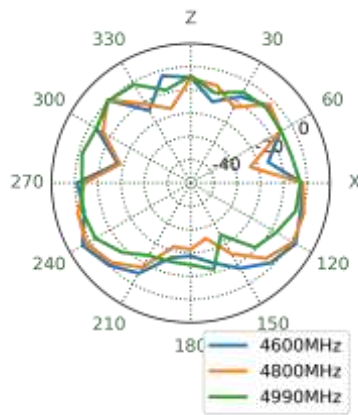

YZ Plane

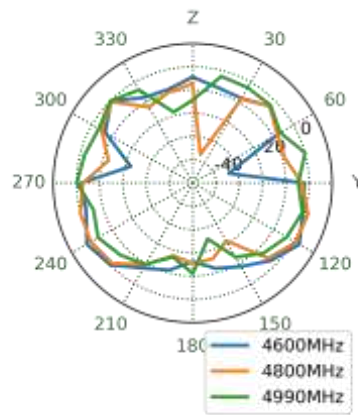

5570MHz

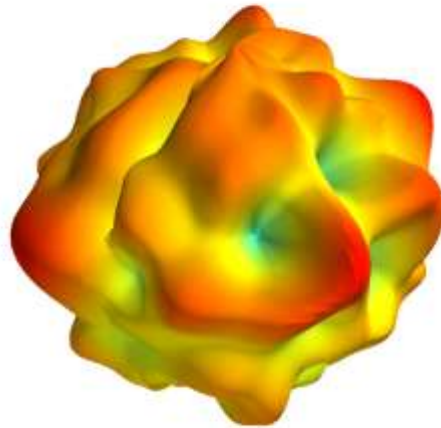

XY Plane

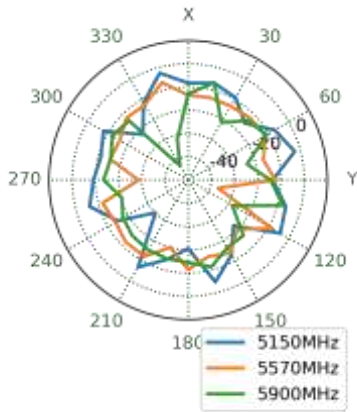

XZ Plane

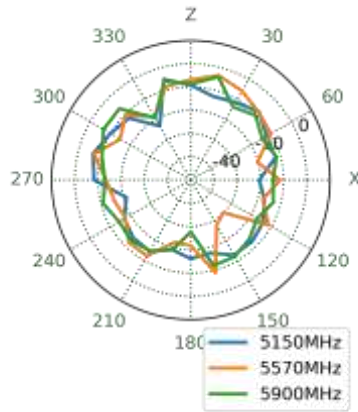

YZ Plane

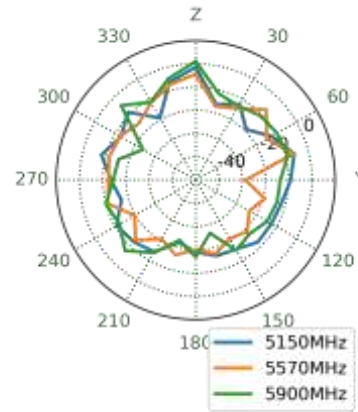

5. Mechanical Drawing (Units: mm)

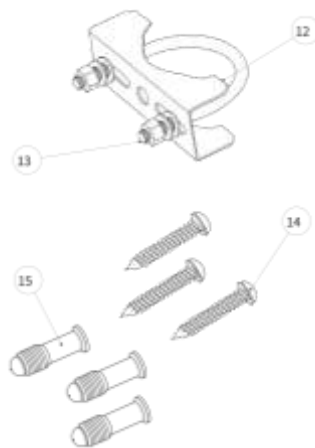
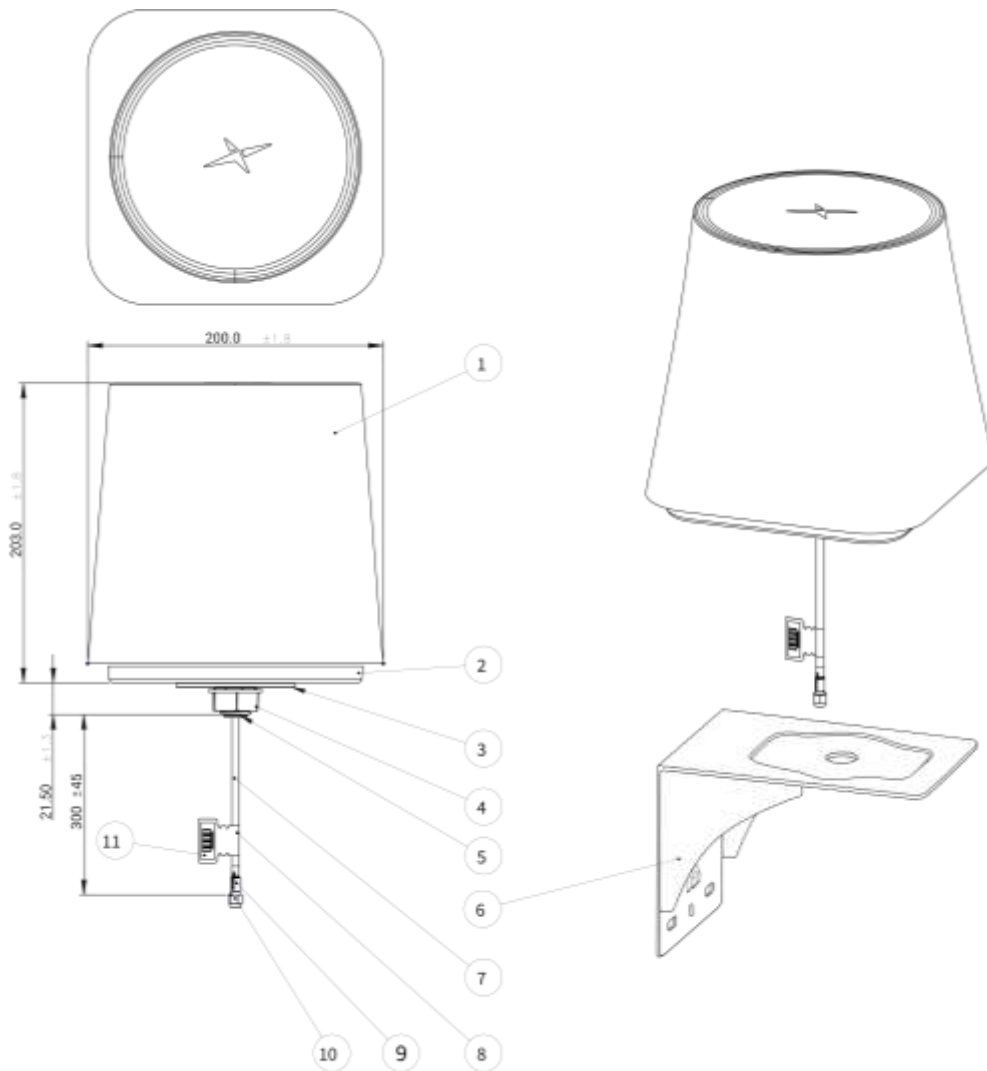

	Name	Material	Finish	QTY
1	DCN.01 Top Housing	ABS	Black	1
2	DCN.01 Bottom Housing	ABS	Black	1
3	DCN Double side adhesive	E43B2+3M 9448	Black Foam/White Liner	1
4	M22 Nut	Nylon	Black	1
5	DCN.D1 Rubber	Silicone Rubber	Black	1
6	DCN.D1 Bracket	SPCC	Black	1
7	TGC200 Coaxial Cable	PE	Black	1
8	Empty Label	PEPA	White	1
9	Heat Shrink Tube(Wideband 400-6000MHz)	PE	Green Tube/White Text	1
10	SMA(M)ST	CU	Au Plated	1
11	Barcode Label	PET	White	1
12	M8 U bolt Accessories	STELL		2
13	Pole mount clip	SUS 204	CLEAR	2
14	Screw TP4*25L	Steel	Ni Plated	3
15	Wall Mount Stud 6*24L	Nylon	White	3

6. Installation Guidelines

Installation Instructions

DCN.01

Wideband, Omnidirectional Discone antenna



Installation Requirements

Antenna Components:

Antenna Housing (x1)

Tightening Nut (x1)

Adhesive Base (x1)

Coaxial Cable (x1)

Mounting Bracket (x1)

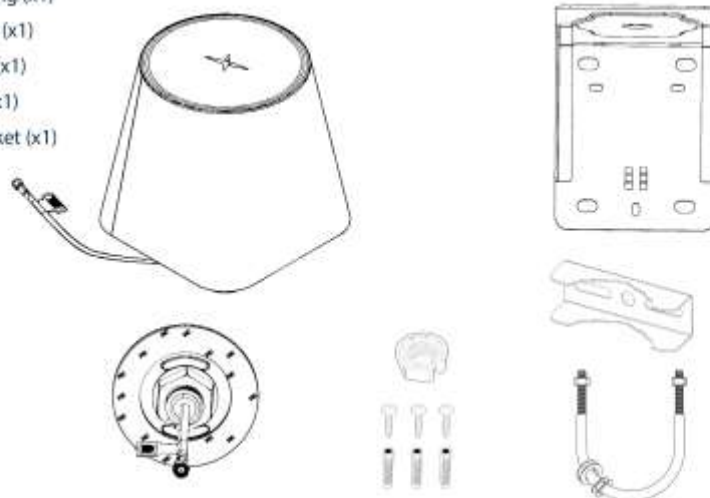

Pole Mount:

13mm [1/2"] Socket Wrench

M8 U Bolt (x2)

M8 Flat Washer (x 4)

M8 Spring Washer (x4)

M8 Hex Nut (x4)

Pole Mount Clip (x2)

Mounting Bracket (x1)

- Pole Diameter Range:
34.5mm [1.3"] - 65.5mm [2.5"]

Wall Mount:

#1 Phillips Screwdriver (Not Included)

Drill (Not Included)

Tapping Screw 4 x 25mm [5/32 x 1"]

Screw (x 3), 6 x 24mm [1/4 x 15/16"]

Wall Mount Stud (x3)

Mounting Bracket (x1)

Hardware Installation

The DCN.01 antenna can be installed via 2 different methods: pole mount and wall mount. Please refer to the appropriate section below for your installation requirements.

Pole Mount

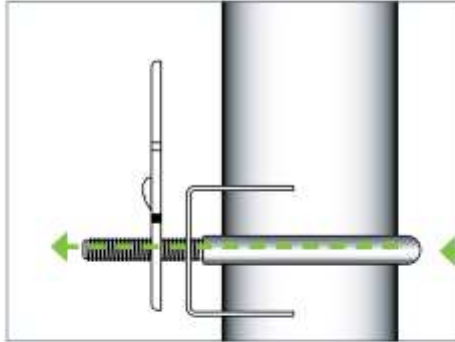

1. Determine the desired antenna location on the pole. Align a mount clip with the two large, bottom screw holes on the bracket. Pressing against the pole at the desired height, insert the U Bolt from the back of the pole, through the mount clip and into the mounting bracket.

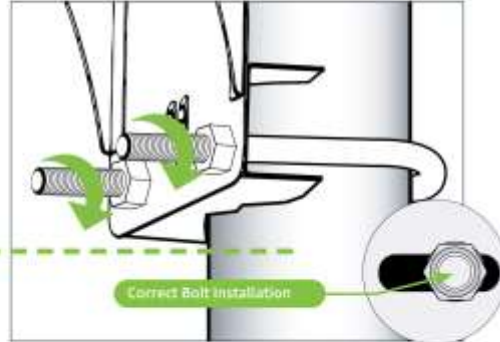

2. Insert the flat washer onto each U Bolt side. Insert a spring washer over the flat one. Insert a hex nut onto each U Bolt end and lightly screw the nut in place by hand. Use a socket wrench to tighten both nuts so the bracket is secured in place.

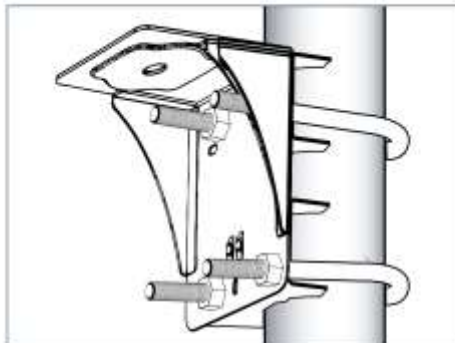

3. Repeat steps 1 and 2 with the top mount clip and U Bolt. Ensure all nuts are properly tightened and the mounting bracket is firmly in place on the pole.



4. Unscrew the tightening nut from the antenna body and slide the coaxial cable through the split in the Nut.

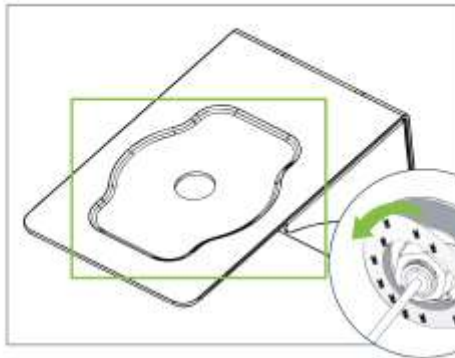

5. Clean the top surface of the mounting bracket and ensure it is completely dry before installing the antenna. Remove the protective liner from the base adhesive of the antenna. Note: Once exposed, avoid contact with the adhesive.



6. Route the coaxial cable through the top opening on the mounting bracket. Align the antenna and press down to secure the adhesive base in place. Note: Avoid sharp bends when routing coaxial cable.



7. Insert the tightening nut and tighten to secure the antenna in place.
Note: Max. Torque for the tightening nut is 10N.m



8. Completed Installation

Wall Mount

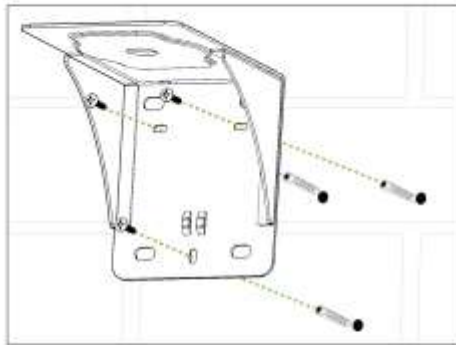

1. Using the mounting bracket as guide, mark the position of the wall screws to the desired location of the bracket (use the three smaller openings on the bracket). Drill holes for the wall mount studs (6mm [1/4"] diameter, min. 25mm [1"] depth) and secure the studs in place. Insert screws through the bracket hole and into the wall studs. Drive the screws in and tighten to secure the mounting bracket in place.



2. Unscrew the tightening nut from the antenna body and slide the coaxial cable through the split in the Nut.

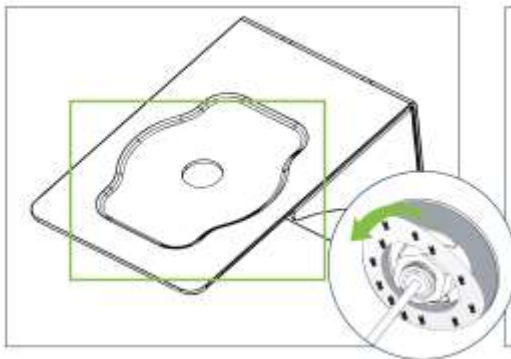

3. Clean the top surface of the mounting bracket and ensure it is completely dry before installing the antenna. Remove the protective liner from the base adhesive of the antenna. Note: Once exposed, avoid contact with the adhesive.



4. Route the coaxial cable through the top opening on the mounting bracket. Align the antenna and press down to secure the adhesive base in place. Note: Avoid sharp bends when routing coaxial cable.



5. Insert the tightening nut and tighten to secure the antenna in place.

Note: Max. Torque for the tightening nut is 10N.m

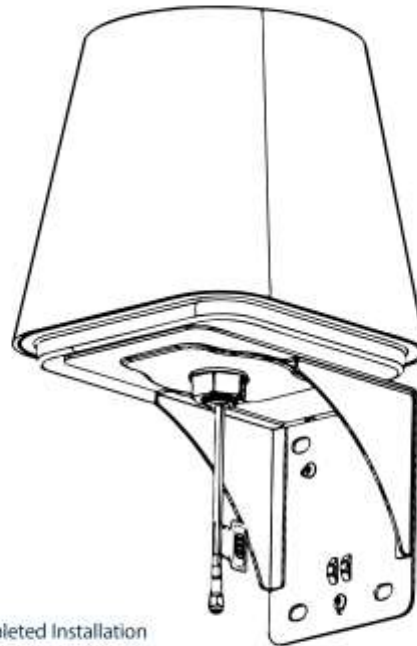

6. Completed Installation

Notices



Caution

To comply with FCC RF Exposure requirements in section 1.1310 of the FCC Rules, antennas used with this device must be installed to provide a separation distance of at least 20 cm from all persons to satisfy RF exposure compliance.



Warning

Do not Operate the transmitter when someone is within 20 cm of the antenna.
Do not operate the equipment in an explosive atmosphere.



European Waste Electronic Equipment Directive 2002/96/EC

Please ensure that your old Waste Electricals and Electronics are recycled do not throw them away into standard waste.

Waiver: This document represents information compiled by Taoglas to the best of our current knowledge. This is not intended to be used as a representation or warranty of fitness of the products described for any particular purpose. This document details guidelines for general information purposes only. When planning installations, always seek specialist advice and ensure that the products are always installed by a properly qualified installer in accordance with applicable regional laws and regulations.

All copyrights, trademarks and any other intellectual property rights related are owned by Taoglas Group Holdings Limited.

7. Packaging

1 pc DCN.01.035111 Pole Mount Kit
 1 SET / Kit box
 Box Dimensions - 140 x 118 x 42mm
 Weight - 387g

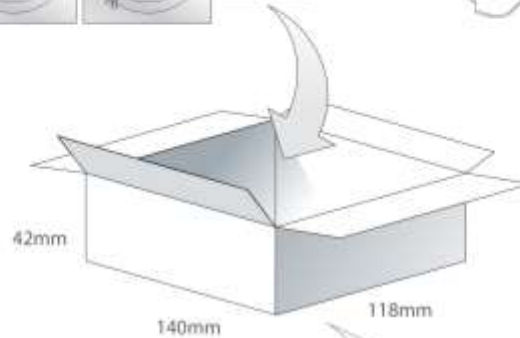
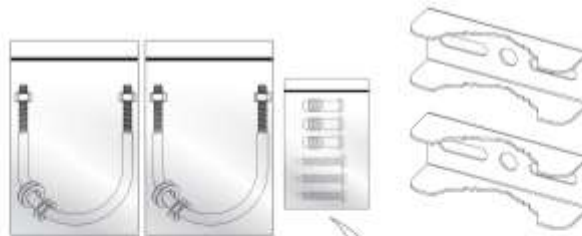

1 pc DCN.01.035111
 1 pc Bracket Assembly for Wind loading
 1 pc Partition
 Weight - 1.78Kg

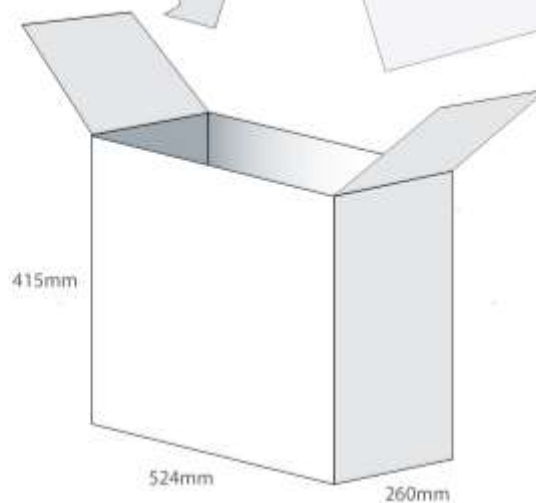
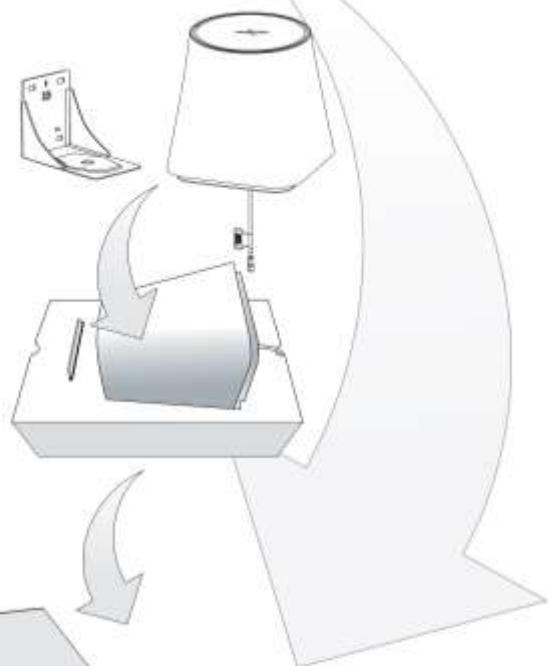

2 pcs per Carton
 Carton Dimensions - 524 x 415 x 260mm
 Weight - 5.86Kg

Changelog for the datasheet

SPE-21-8-005 – DCN.01.305111

Revision: A (Original First Release)

Date:	2021-05-11
Notes:	
Author:	Jack Conroy

Previous Revisions
