

IEC Appliance Inlet C14 with Filter, Fuseholder 1- or 2-pole, Line Switch 2-pole

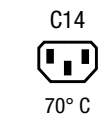

See below:
[Approvals and Compliances](#)

Description

- Panel mount :
 Screw-on from front side
- 4 Functions :
 Appliance Inlet Protection class I , Line Switch 2-pole , Fuseholder for fuse-links 5 x 20 mm 1- or 2-pole , Line filter in standard and medical version
- V-Lock notch standard
- Quick connect terminals 6.3 x 0.8 mm

Unique Selling Proposition

- Various mounting options
- Attractive flat design
- Switch for highest inrush current
- V-Lock cord retaining

Characteristics

- Ultra-compact design. Ideal for low profile designs
 Aluminum case provides good shielding
- All single elements are already wired
- Ideal for application with high transient loads
- For applications according IEC/UL 62368-1 we recommend variants with bleed resistor
 Suitable for use in medical equipment according to IEC/UL 60601-1 (1 MOOP, 1 MOPP)

Other versions on request

- Solder terminals
- Other rocker marking
- Line switch, illuminated
- Line switch 1-pole
- Medical Version (M80)
- Class X1- and Y1-capacitors for enhanced withstand voltage

References

- Alternative: version without line filter [DD11](#)
- Alternative: version for snap-in mounting [KMF](#)
- Alternative: version with 2-stage filter [DD14](#)

Weblinks

[pdf data sheet](#), [html datasheet](#), [General Product Information](#), [Approvals](#), [Distributor-Stock-Check](#), [Accessories](#), [Detailed request for product](#)

Technical Data

Ratings IEC	1 - 10A @ Ta 40 °C / 250VAC; 50Hz	Appliance inlet/-outlet	C14 acc. to IEC 60320-1
Ratings UL/CSA	1 - 10A @ Ta 40 °C / 250VAC; 60Hz	Fuseholder	UL 498, CSA C22.2 no. 42 (for cold conditions) pin-temperature 70 °C, 10A, Protection Class I
Leakage Current	standard < 0.5 mA (250 V / 60Hz) medical < 5 µA (250 V / 60 Hz)	Rated Power Acceptance @ Ta 23 °C	1-/2-pole, Shocksafe category PC2 acc. to IEC 60127-6, for fuse-links 5 x 20mm
Dielectric Strength	> 1.7 kVDC between L-N > 2.7 kVDC between L/N-PE Test voltage (2 sec)	Power Acceptance @ Ta > 23°C	5 x 20: 2W (1 pole)/ 1.6W (2-pole) per pole Admissible power acceptance at higher ambient temperature see derating curves
Allowable Operation Temperature	-25 °C to 85 °C	Line Switch	Rocker switch 2-pole, non-illuminated, acc. to IEC 61058-1 Technical Details
Climatic Category	25/085/21 acc. to IEC 60068-1	Line Filter	Standard and Medical Version, IEC 60939, UL 60939-3, CSA C22.2 no. 8 Technical Details
IP-Protection	front side IP40 acc. to IEC 60529	MTBF	> 2'000'000 h acc. to MIL-HB-217 F
Protection Class	Suitable for appliances with protection class I acc. to IEC 61140		
Terminal	Quick connect terminals 6.3 x 0.8 mm		
Panel Thickness S	Screw-on mounting: max 8mm Mounting screw torque max 0.5Nm Snap-in: 1 mm to 3mm		
Material	Thermoplastic, black, UL 94V-0		

Approvals and Compliances



Detailed information on product approvals, code requirements, usage instructions and detailed test conditions can be looked up in [Details about Approvals](#)

SCHURTER products are designed for use in industrial environments. They have approvals from independent testing bodies according to national and international standards. Products with specific characteristics and requirements such as required in the automotive sector according to IATF 16949, medical technology according to ISO 13485 or in the aerospace industry can be offered exclusively with customer-specific, individual agreements by SCHURTER.

Approvals









The approval mark is used by the testing authorities to certify compliance with the safety requirements placed on electronic products.

Approval Reference Type: DD12

Approval Logo	Certificates	Certification Body	Description
	VDE Approvals	VDE	Certificate Number: 40001522
	UL Approvals	UL	UR File Number: E495089
	CQC Approvals	CQC	CQC Certificate Number: 20001257136, 22001363465



Product standards

Product standards that are referenced

Organization	Design	Standard	Description
	Designed according to	IEC 60320-1	Appliance couplers for household and similar general purposes
	Designed according to	IEC 60939	Passive filters for suppressing electromagnetic interference
	Designed according to	IEC 60127-6	Miniature fuses. Part 6. Fuse-holders for miniature fuse-links
	Designed according to	IEC 61058-1	Switches for appliances. Part 1. General requirements
	Designed according to	UL 498	Standard for Attachment Plugs and Receptacles
	Designed according to	UL 60939-3	Passive filters for suppressing electromagnetic interference
	Designed according to	CSA C22.2 no. 42	General Use Receptacles, Attachment Plugs, and Similar Wiring Devices
	Designed according to	CSA C22.2 no. 8	Electromagnetic interference (EMI) filters









Application standards

Application standards where the product can be used

Organization	Design	Standard	Description
	Suitable for applications acc.	IEC/UL 62368-1	Audio/video, information and communication technology equipment - Part 1: Safety requirements
	Suitable for applications acc.	IEC 60601-1	Medical electrical equipment - Part 1: General requirements for basic safety and essential performance
	Suitable for applications acc.	IEC 60335-1	Safety of electrical appliances for household and similar purposes. Meets the requirements for appliances in unattended use. This includes the enhanced requirements of glow wire tests acc. to IEC 60695-2-11 or -12 & -13.

Compliances

The product complies with following Guide Lines

Identification	Details	Initiator	Description
	CE declaration of conformity	SCHURTER AG	The CE marking declares that the product complies with the applicable requirements laid down in the harmonisation of Community legislation on its affixing in accordance with EU Regulation 765/2008.
	UKCA declaration of conformity	SCHURTER AG	The UKCA marking declares that the product complies with the applicable requirements laid down in the British Amendment of Regulation (EC) 765/2008.
	RoHS	SCHURTER AG	Directive RoHS 2011/65/EU, Amendment (EU) 2015/863
	China RoHS	SCHURTER AG	The law SJ / T 11363-2006 (China RoHS) has been in force since 1 March 2007. It is similar to the EU directive RoHS.
	REACH	SCHURTER AG	On 1 June 2007, Regulation (EC) No 1907/2006 on the Registration, Evaluation, Authorization and Restriction of Chemicals 1 (abbreviated as "REACH") entered into force.
		SCHURTER AG	V-Lock system are based on a matching plug-dose combination. The connector is equipped with a notch intended for use with the latching cordset. The cord latching system prevents against accidental removal of the cordset.
	White Paper Glow wire test	SCHURTER AG	Meets the requirements of IEC 60335-1 for appliances in unattended use. This includes the enhanced requirements of glow wire tests acc. to IEC 60695-2-11 or -12 & -13.
	Medical Equipment	SCHURTER AG	Suitable for use in medical equipment according to IEC/UL 60601-1 (1 MOOP, 1 MOPP)

Dimensions [mm]

Screw version A

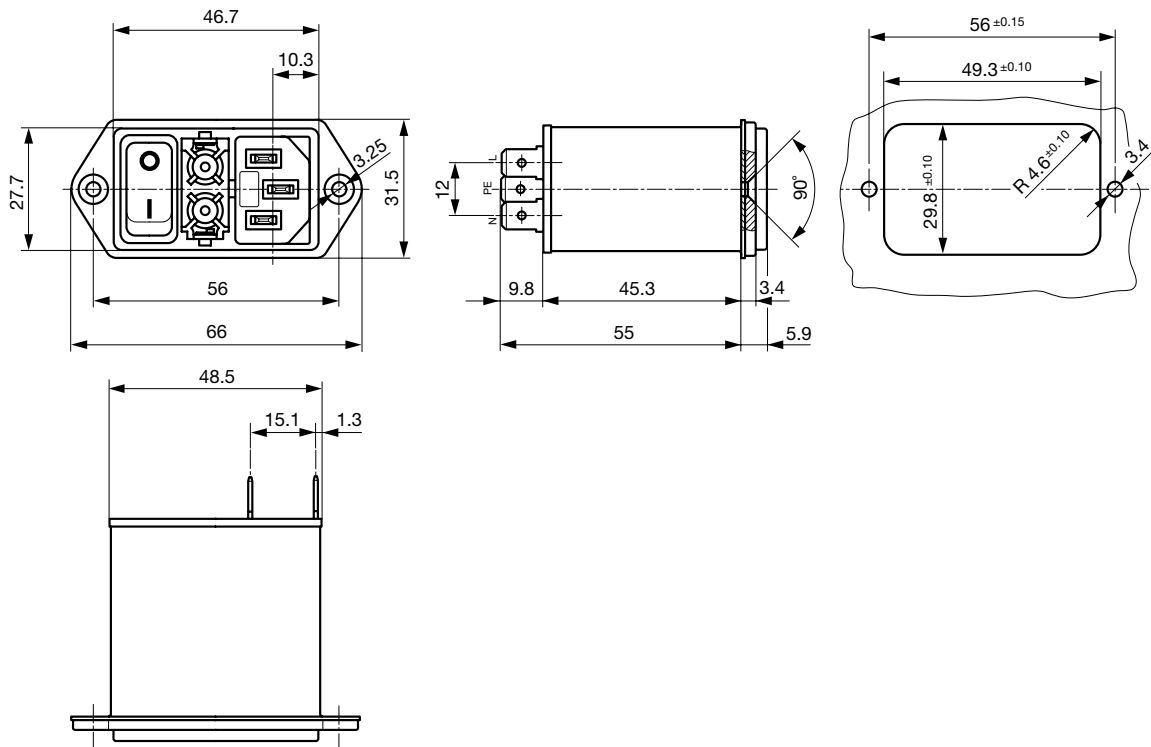

Screw version B

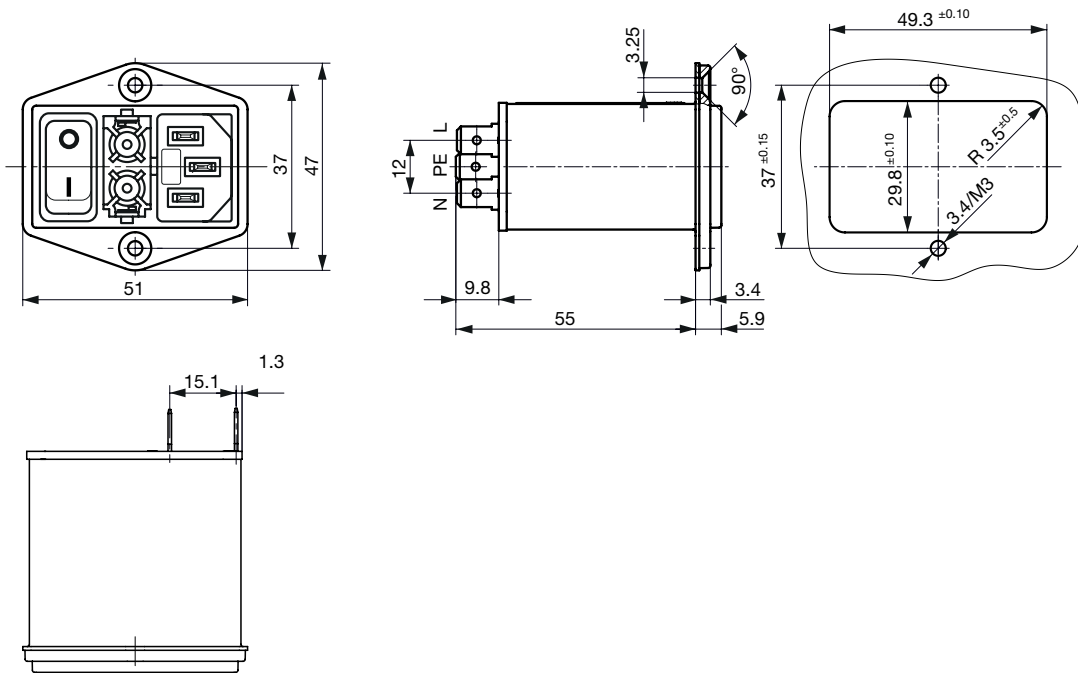

Snap-in mounting from front side

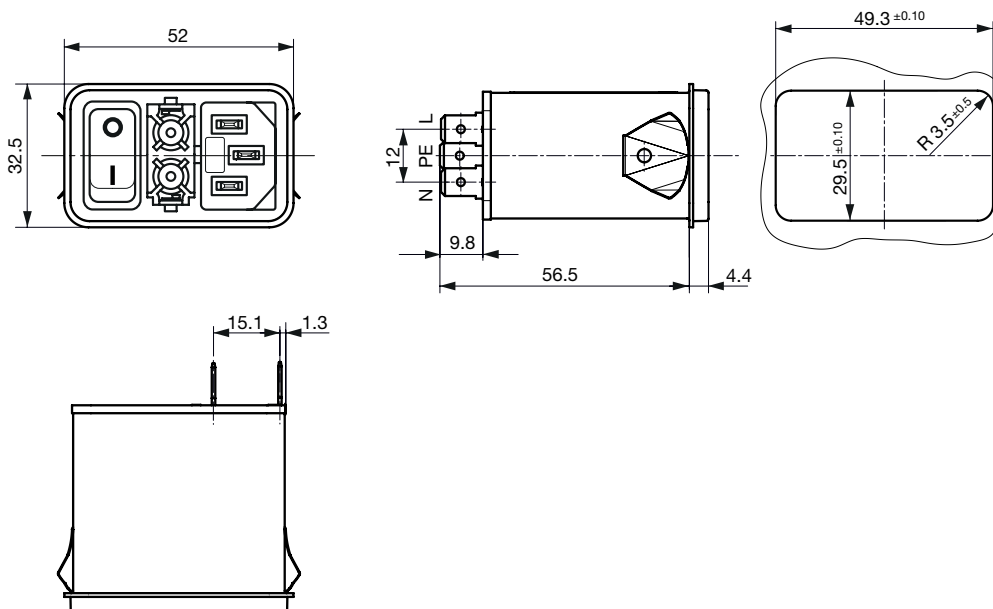

Technical Data of Filter-Components

Rated Current [A]	Filter-Type	Inductance L1/ L2 [mH]	Inductance L3 [mH]	Capacitance CX [nF]	Capacitance CY [nF]	R [MΩ]
1	Standard version	2 x 10	-	100	2.2	1
2	Standard version	2 x 4	-	100	2.2	1
4	Standard version	2 x 1.5	-	100	2.2	1
6	Standard version	2 x 0.8	-	100	2.2	1
8	Standard version	2 x 0.6	-	100	2.2	1
10	Standard version	2 x 0.3	-	100	2.2	1
6	Standard Version with Ground Line Choke	2 x 0.8	0.6	100	2.2	1
10	Standard Version with Ground Line Choke	2 x 0.3	0.15	100	2.2	1
1	Medical Version (M5)	2 x 10	-	100	-	1
2	Medical Version (M5)	2 x 4	-	100	-	1
4	Medical Version (M5)	2 x 1.5	-	100	-	1
6	Medical Version (M5)	2 x 0.8	-	100	-	1
8	Medical Version (M5)	2 x 0.6	-	100	-	1
10	Medical Version (M5)	2 x 0.3	-	100	-	1
1	Medical Version (M80)	2 x 10	-	100	0.47	1

Diagrams

Standard Version, medical Version M80
 Non-illuminated

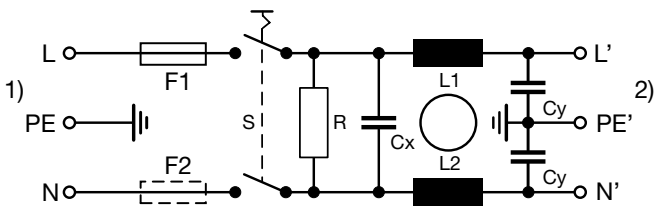

1) Line
 2) Load

Medical Version (M5)
 Non-illuminated

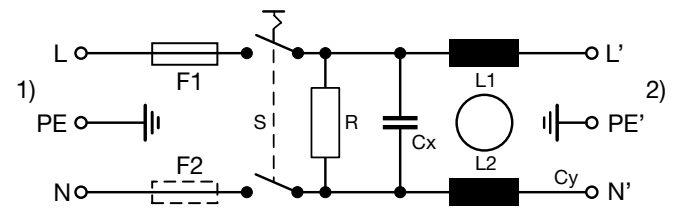

1) Line
 2) Load

Standard Version, medical Version M80
 with PE-choke

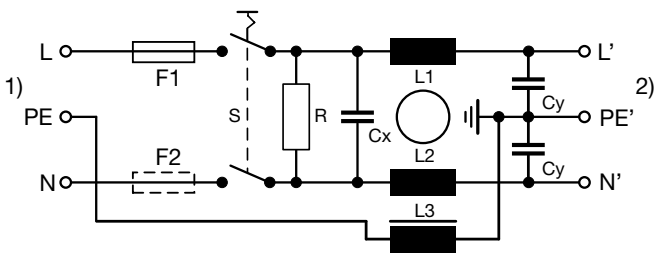

1) Line
 2) Load

Medical Version (M5)
 with PE-choke

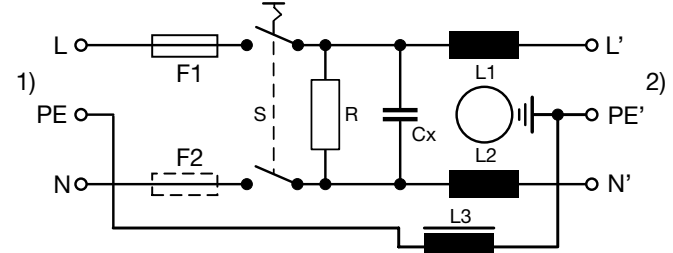

1) Line
 2) Load

Derating Curves

1-pole

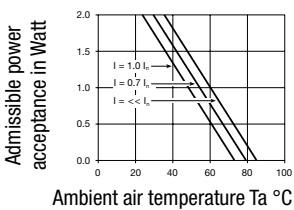

2-pole

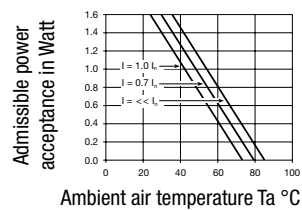

Attenuation Loss

--- 50Ω differential mode ____ 50Ω common mode

Standard version

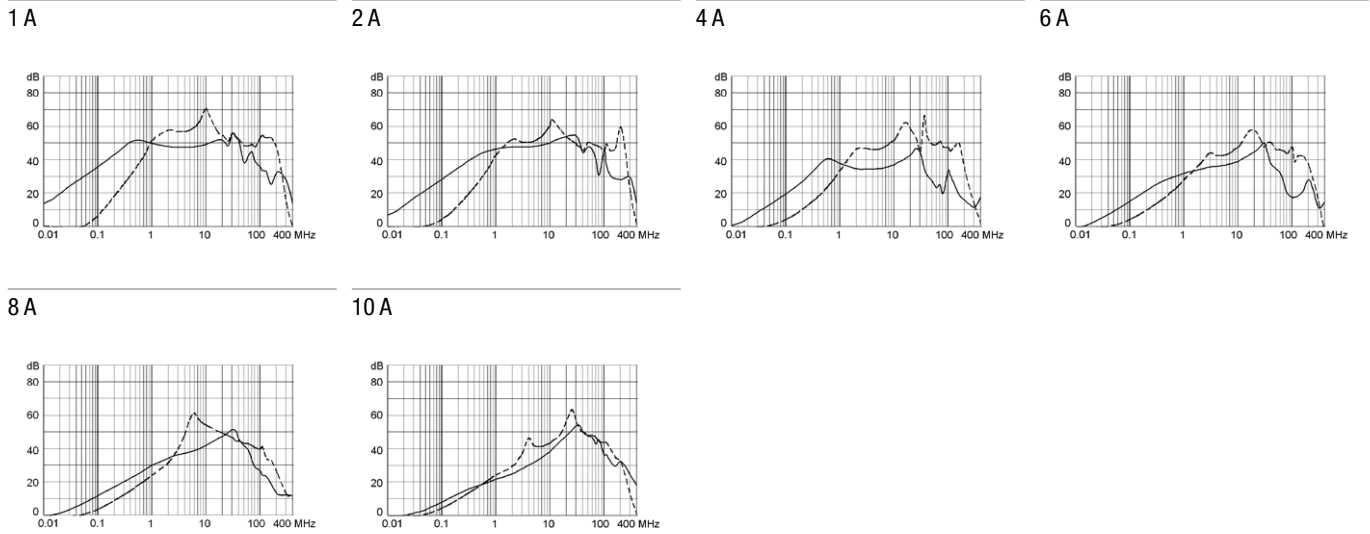

Medical version (M5)

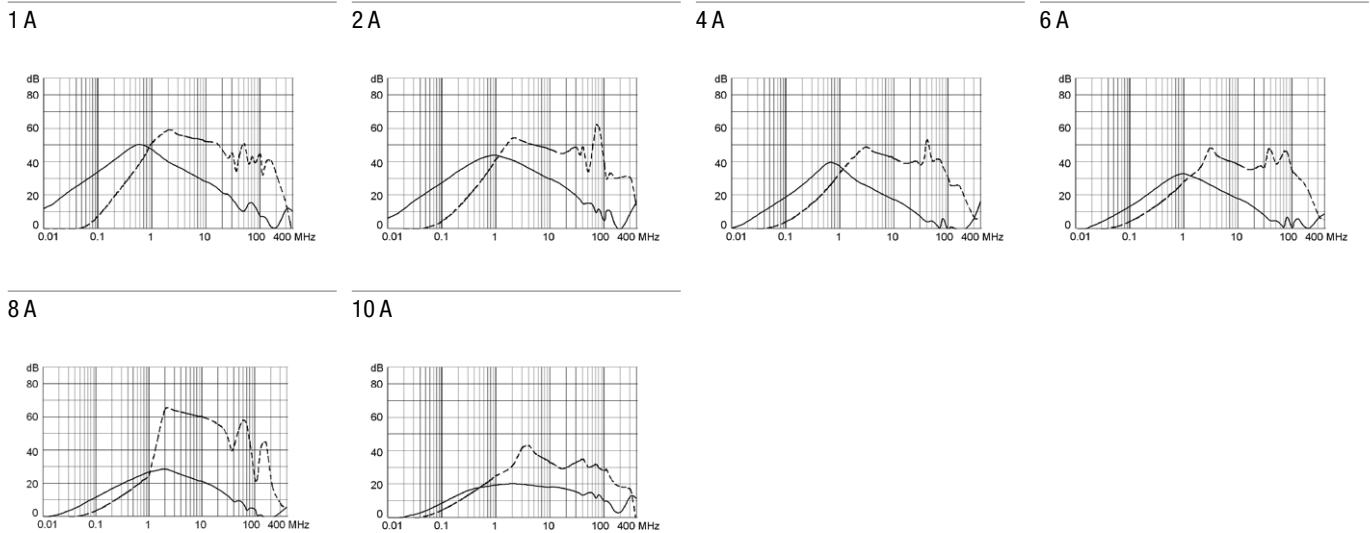

All Variants

Rated Current [A]	Filter-Type	Mounting	Fuseholder	Line Switch	Illumination	Color	Order Number
1	Standard version	Screw-on A	1-pole	2-pole	non-illuminated	black	DD12.1111.111
1	Standard version	Snap-in	2-pole	2-pole	non-illuminated	black	3-107-465
1	Standard version	Screw-on B	2-pole	2-pole	non-illuminated	black	3-109-955
1	Standard version	Screw-on A	2-pole	2-pole	non-illuminated	black	DD12.1121.111
2	Standard version	Screw-on A	1-pole	2-pole	non-illuminated	black	DD12.2111.111
2	Standard version	Snap-in	2-pole	2-pole	non-illuminated	black	3-107-466
2	Standard version	Screw-on B	2-pole	2-pole	non-illuminated	black	3-109-956
2	Standard version	Screw-on A	2-pole	2-pole	non-illuminated	black	DD12.2121.111
2	Standard version	Screw-on A	2-pole	2-pole	illuminated, red	black	DD12.2123.111
2	Standard version	Screw-on A	2-pole	2-pole	illuminated, green	black	DD12.2124.111
4	Standard version	Screw-on B	1-pole	2-pole	non-illuminated	black	3-110-001
4	Standard version	Snap-in	1-pole	2-pole	non-illuminated	black	3-110-032
4	Standard version	Screw-on A	1-pole	2-pole	non-illuminated	black	DD12.4111.111

Rated Current [A]	Filter-Type	Mounting	Fuseholder	Line Switch	Illumination	Color	Order Number
4	Standard version	Snap-in	2-pole	2-pole	non-illuminated	black	3-107-467
4	Standard version	Screw-on B	2-pole	2-pole	non-illuminated	black	3-109-957
4	Standard version	Screw-on A	2-pole	2-pole	non-illuminated	black	DD12.4121.111
6	Standard version	Snap-in	1-pole	2-pole	non-illuminated	black	3-110-010
6	Standard version	Screw-on B	1-pole	2-pole	non-illuminated	black	3-110-031
6	Standard version	Screw-on A	1-pole	2-pole	non-illuminated	black	DD12.6111.111
6	Standard version	Screw-on B	2-pole	2-pole	non-illuminated	black	3-102-857
6	Standard version	Snap-in	2-pole	2-pole	non-illuminated	black	3-102-861
6	Standard version	Screw-on A	2-pole	2-pole	non-illuminated	black	DD12.6121.111
6	Standard version	Screw-on A	2-pole	2-pole	illuminated red	black	DD12.6123.111
8	Standard version	Screw-on A	1-pole	2-pole	non-illuminated	black	DD12.8111.111
8	Standard version	Snap-in	2-pole	2-pole	non-illuminated	black	3-107-468
8	Standard version	Screw-on B	2-pole	2-pole	non-illuminated	black	3-109-958
8	Standard version	Screw-on A	2-pole	2-pole	non-illuminated	black	DD12.8121.111
10	Standard version	Screw-on A	1-pole	2-pole	non-illuminated	black	DD12.9111.111
10	Standard version	Screw-on B	2-pole	2-pole	non-illuminated	black	3-105-315
10	Standard version	Snap-in	2-pole	2-pole	non-illuminated	black	3-107-469
10	Standard version	Screw-on A	2-pole	2-pole	non-illuminated	black	DD12.9121.111
6	Standard Version with Ground Line Choke	Screw-on B	2-pole	2-pole	non-illuminated	black	3-109-943
10	Standard Version with Ground Line Choke	Screw-on A	2-pole	2-pole	non-illuminated	black	3-102-855
1	Medical Version (M5)	Snap-in	2-pole	2-pole	non-illuminated	black	3-107-472
1	Medical Version (M5)	Screw-on B	2-pole	2-pole	non-illuminated	black	3-109-994
1	Medical Version (M5)	Screw-on A	2-pole	2-pole	non-illuminated	black	DD12.1321.111
2	Medical Version (M5)	Snap-in	2-pole	2-pole	non-illuminated	black	3-107-473
2	Medical Version (M5)	Screw-on B	2-pole	2-pole	non-illuminated	black	3-109-995
2	Medical Version (M5)	Screw-on A	2-pole	2-pole	non-illuminated	black	DD12.2321.111
4	Medical Version (M5)	Snap-in	2-pole	2-pole	non-illuminated	black	3-107-474
4	Medical Version (M5)	Screw-on B	2-pole	2-pole	non-illuminated	black	3-109-997
4	Medical Version (M5)	Screw-on A	2-pole	2-pole	non-illuminated	black	DD12.4321.111
6	Medical Version (M5)	Snap-in	2-pole	2-pole	non-illuminated	black	3-107-475
6	Medical Version (M5)	Screw-on B	2-pole	2-pole	non-illuminated	black	3-109-998
6	Medical Version (M5)	Screw-on A	2-pole	2-pole	non-illuminated	black	DD12.6321.111
8	Medical Version (M5)	Snap-in	2-pole	2-pole	non-illuminated	black	3-107-476
8	Medical Version (M5)	Screw-on B	2-pole	2-pole	non-illuminated	black	3-109-999
8	Medical Version (M5)	Screw-on A	2-pole	2-pole	non-illuminated	black	DD12.8321.111
10	Medical Version (M5)	Snap-in	2-pole	2-pole	non-illuminated	black	3-107-477
10	Medical Version (M5)	Screw-on B	2-pole	2-pole	non-illuminated	black	3-110-000
10	Medical Version (M5)	Screw-on A	2-pole	2-pole	non-illuminated	black	DD12.9321.111
1	Medical Version (M80)	Screw-on A	2-pole	2-pole	non-illuminated	black	DD12.1621.111

Most Popular.

Availability for all products can be searched real-time: <https://www.schurter.com/en/Stock-Check/Stock-Check-SCHURTER>

10 A version only IEC approval.

The fuse drawer is not included and must be ordered separately (see required accessory).

Packaging unit

10 Pcs

Required Accessory

Description

[Fusedrawer_2](#)

Fusedrawer for Fuse Links 5x20 mm, with or without Voltage Selector Insert



Fingergrip, 2-pole	4301.1401
Extra-Safe, 2-pole	4301.1403
Fingergrip, 1-pole	4301.1405
Extra-Safe, 1-pole	4301.1407
...	

Accessories

[Wire_Harness](#)

Wire harness for SCHURTER products



[Assorted_Covers](#)

Rear Cover



	0859.0076
--	-----------

[RC320](#)

Rear Cover for Power Entry Module



[Cord_retaining_kits](#)

Cord retaining strain relief



Flat head, A	4700.0001
--------------	-----------

Mating Outlets/Connectors

Category / Description

[Appliance Outlet Overview complete](#)



4787, Mounting: Screw-on mounting, Appliance Outlet: IEC Solder terminals, 10 A, Suitable for appliances with protection class I	4787
4788, Mounting: Snap-in version, Appliance Outlet: IEC Solder / Quick Connect, 10 A, Suitable for appliances with protection class I	4788
IEC Appliance Outlet F or H, Screw-on Mounting, Front Side, Solder, PCB or Quick-connect Terminal	5091