

N

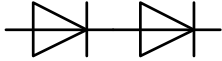

Datenblatt / Data sheet

Netz-Dioden-Modul
Rectifier Diode Module
DD171N

 Infineon Technologies Bipolar
 GmbH & Co. KG

DD171N
ND171N
DD171N..K..-A
DD171N..K..-K
Elektrische Eigenschaften / Electrical properties
 Höchstzulässige Werte / Maximum rated values

Periodische Spitzensperrspannung repetitive peak reverse voltages	$T_{vj} = -40^{\circ}\text{C} \dots T_{vj\text{max}}$	V_{RRM}	1200 1600	1400 1800	V V
Stoßspitzensperrspannung non-repetitive peak reverse voltage	$T_{vj} = +25^{\circ}\text{C} \dots T_{vj\text{max}}$	V_{RSM}	1300 1700	1500 1900	V V
Durchlaßstrom-Grenzeffektivwert maximum RMS on-state current		I_{FRMSM}		270	A
Dauergrenzstrom average on-state current	$T_C = 100^{\circ}\text{C}$	I_{FAVM}		171	A
Stoßstrom-Grenzwert surge current	$T_{vj} = 25^{\circ}\text{C}, t_p = 10\text{ ms}$ $T_{vj} = T_{vj\text{max}}, t_p = 10\text{ ms}$	I_{FSM}		6.600 5.600	A A
Grenzlastintegral I^2t -value	$T_{vj} = 25^{\circ}\text{C}, t_p = 10\text{ ms}$ $T_{vj} = T_{vj\text{max}}, t_p = 10\text{ ms}$	I^2t		218.000 157.000	A ² s A ² s

Charakteristische Werte / Characteristic values

Durchlaßspannung on-state voltage	$T_{vj} = T_{vj\text{max}}, I_F = 500\text{ A}$	V_F	max.	1,26	V
Schleusenspannung threshold voltage	$T_{vj} = T_{vj\text{max}}$	$V_{(TO)}$		0,75	V
Ersatzwiderstand slope resistance	$T_{vj} = T_{vj\text{max}}$	r_T		0,8	mΩ
Sperrstrom reverse current	$T_{vj} = T_{vj\text{max}}, V_R = V_{RRM}$	i_R	max.	20	mA
Isolations-Prüfspannung insulation test voltage	RMS, $f = 50\text{ Hz}, t = 1\text{ sec}$ RMS, $f = 50\text{ Hz}, t = 1\text{ min}$	V_{ISOL}		3,0 2,5	kV kV

Thermische Eigenschaften / Thermal properties

Innerer Wärmewiderstand thermal resistance, junction to case	pro Modul / per Module, $\Theta = 180^{\circ}\text{ sin}$ pro Zweig / per arm, $\Theta = 180^{\circ}\text{ sin}$ pro Modul / per Module, DC pro Zweig / per arm, DC	R_{thJC}	max.	0,130 0,260 0,126 0,252	°C/W °C/W °C/W °C/W
Übergangs-Wärmewiderstand thermal resistance, case to heatsink	pro Modul / per Module pro Zweig / per arm	R_{thCH}	max.	0,03 0,06	°C/W °C/W
Höchstzulässige Sperrschichttemperatur maximum junction temperature		$T_{vj\text{max}}$		150	°C
Betriebstemperatur operating temperature		$T_{c\text{op}}$		- 40...+150	°C
Lagertemperatur storage temperature		T_{stg}		- 40...+150	°C

prepared by:	A.Glunz	date of publication:	2016-01-28
approved by:	M.Leifeld	revision:	3.1

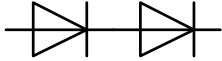
N**Datenblatt / Data sheet**
Netz-Dioden-Modul
Rectifier Diode Module
DD171N
 Infineon Technologies Bipolar
 GmbH & Co. KG
Mechanische Eigenschaften / Mechanical properties

Gehäuse, siehe Anlage case, see annex			Seite 3 page 3	
Si-Element mit Druckkontakt Si-pellet with pressure contact				
Innere Isolation internal insulation			AIN	
Anzugsdrehmoment für mechanische Anschlüsse mounting torque	Toleranz ±15%	M1	6	Nm
Anzugsdrehmoment für elektrische Anschlüsse terminal connection torque	Toleranz ±10%	M2	6	Nm
Gewicht weight		G	typ. 310	g
Kriechstrecke creepage distance			15	mm
Schwingfestigkeit vibration resistance	f = 50 Hz		50	m/s ²
	file-No.		E 83336	

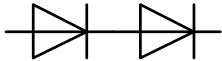
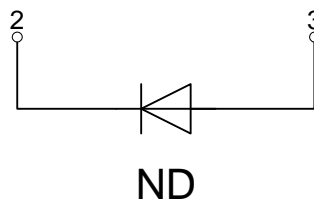
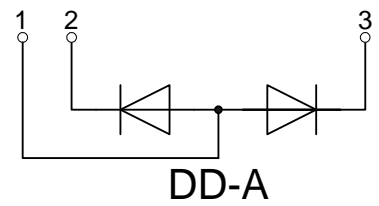
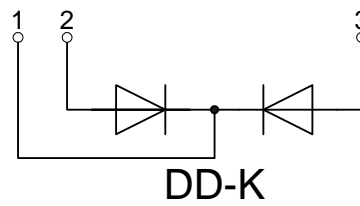
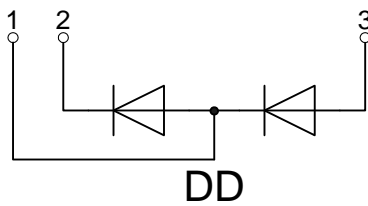
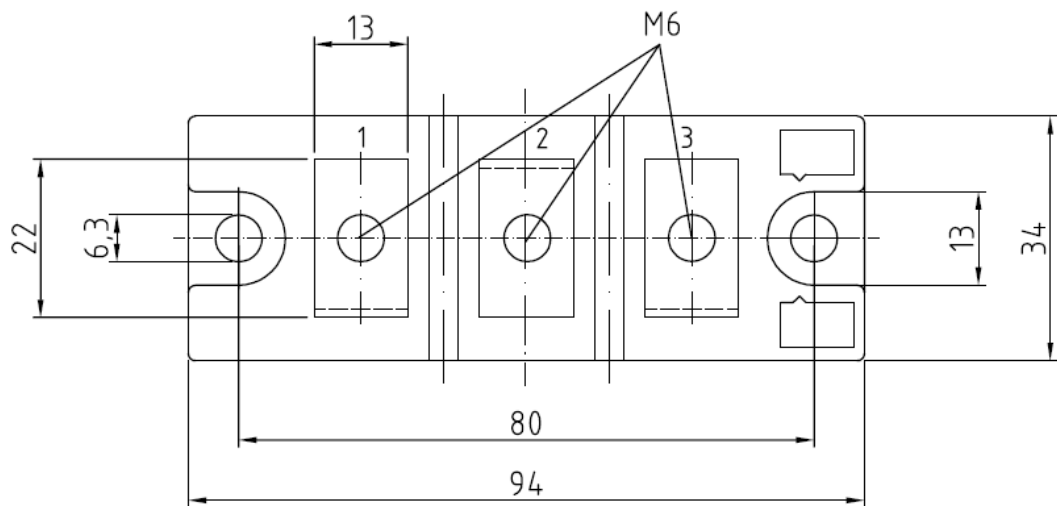
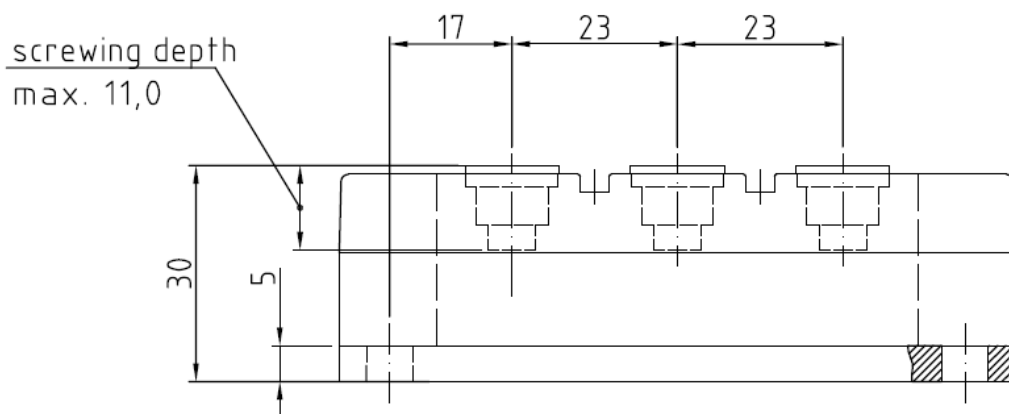
N**Datenblatt / Data sheet**
Netz-Dioden-Modul
Rectifier Diode Module
DD171N
 Infineon Technologies Bipolar
 GmbH & Co. KG

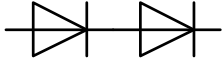

Analytische Elemente des transienten Wärmewiderstandes Z_{thJC} für DC
Analytical elements of transient thermal impedance Z_{thJC} for DC

Pos. n	1	2	3	4	5	6	7
R_{thn} [°C/W]	0,0094	0,0224	0,0586	0,162			
T_n [s]	0,0014	0,0253	0,267	1,68			

Analytische Funktion / Analytical function:

$$Z_{thJC} = \sum_{n=1}^{n_{max}} R_{thn} \left(1 - e^{-\frac{t}{T_n}} \right)$$

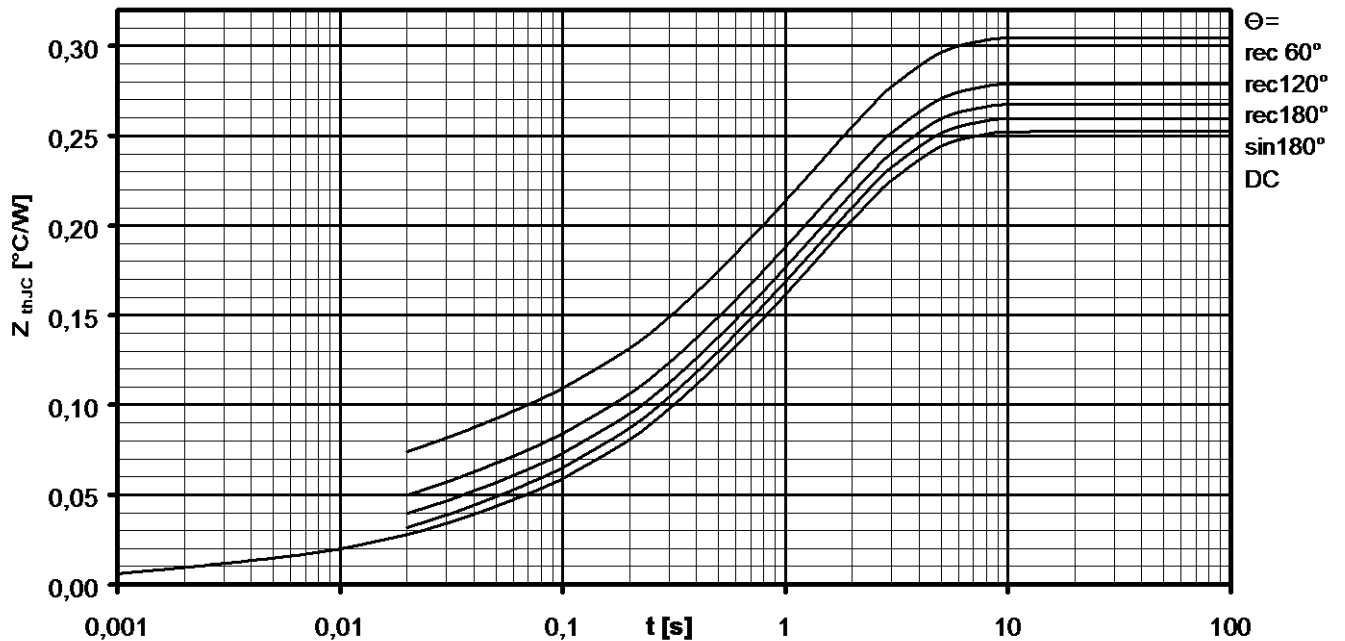

Transienter innerer Wärmewiderstand je Zweig / Transient thermal impedance per arm $Z_{thJC} = f(t)$

Parameter: Stromflußwinkel Θ / Current conduction angle Θ

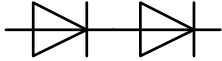

Natürliche Kühlung / Natural cooling
 3 Module pro Kühler / 3 modules per heatsink
 Kühler / Heatsink type: KM17 (60W)

Analytische Elemente des transienten Wärmewiderstandes Z_{thCA}
Analytical elements of transient thermal impedance Z_{thCA}

Pos. n	1	2	3	4	5	6	7
R_{thn} [°C/W]	0,0505	0,1235	1,616				
T_n [s]	2,97	21,4	1180				

Verstärkte Kühlung / Forced cooling
 3 Module pro Kühler / 3 modules per heatsink
 Kühler / Heatsink type: KM17 (Papst 4650)

Analytische Elemente des transienten Wärmewiderstandes Z_{thCA}
Analytical elements of transient thermal impedance Z_{thCA}

Pos. n	1	2	3	4	5	6	7
R_{thn} [°C/W]	0,026	0,119	0,515				
T_n [s]	2,41	13,6	354				

Analytische Funktion / Analytical function:

$$Z_{thCA} = \sum_{n=1}^{n_{max}} R_{thn} \left(1 - e^{-\frac{t}{T_n}} \right)$$

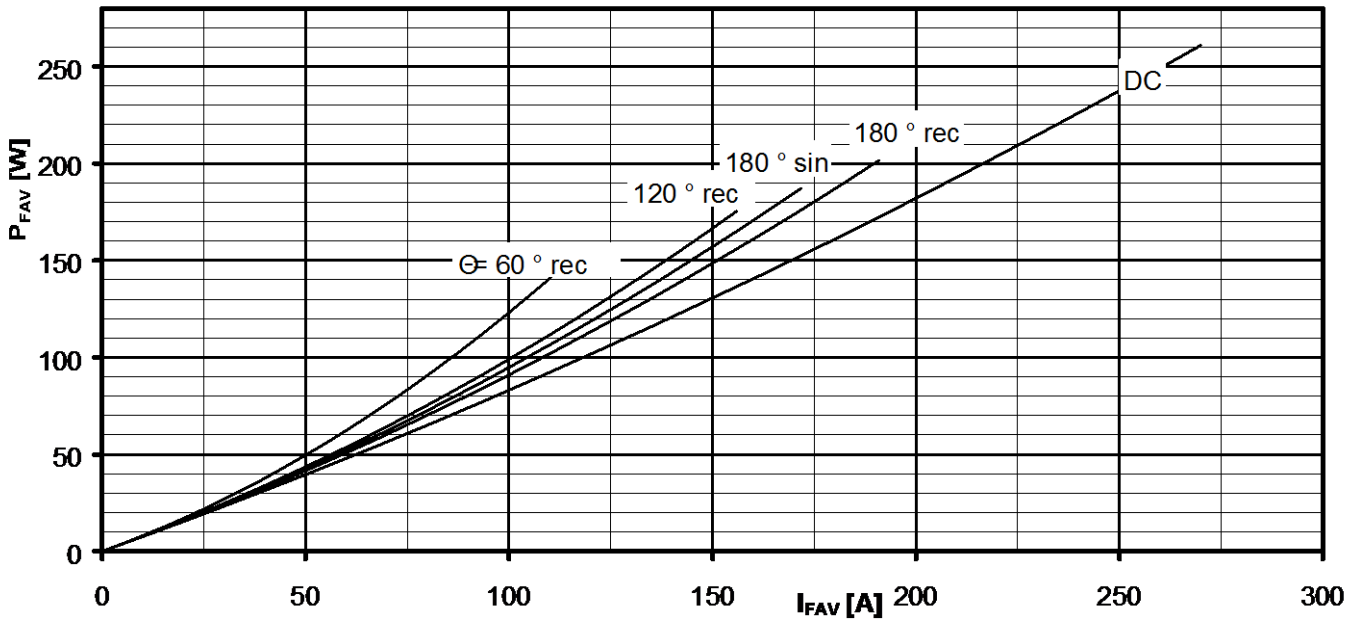
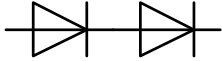

Durchlassverlustleistung je Zweig / On-state power loss per arm $P_{FAV} = f(I_{FAV})$

Parameter: Stromflußwinkel / Current conduction angle Θ

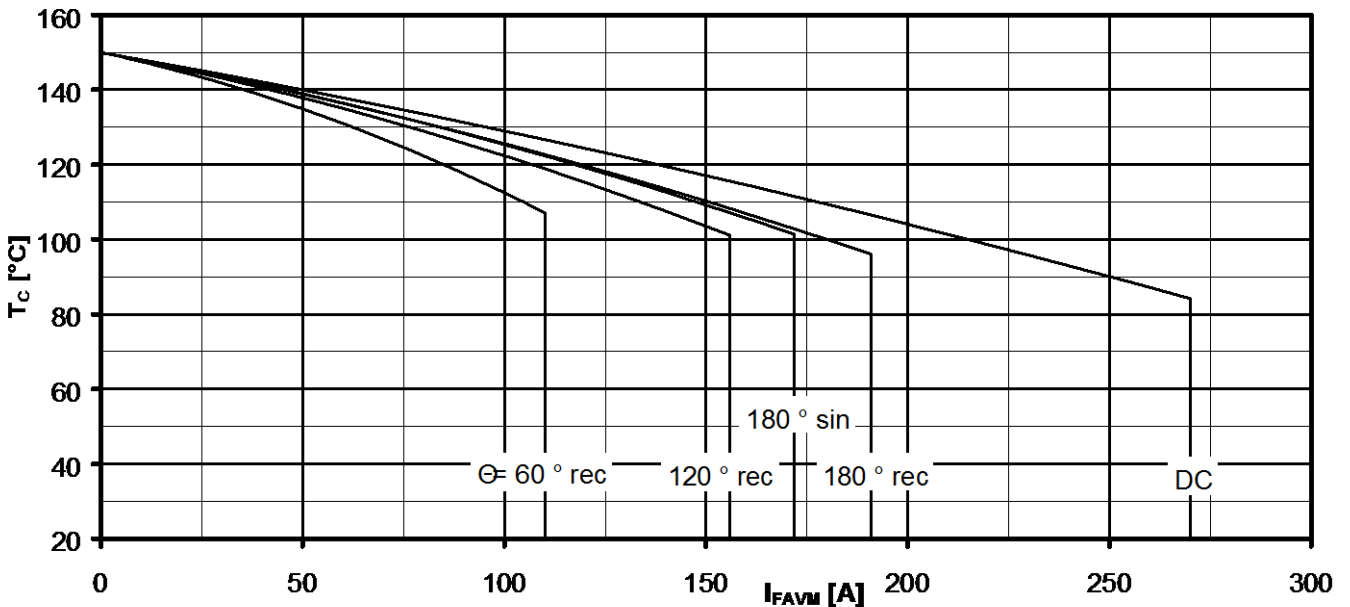

Höchstzulässige Gehäusetemperatur / Maximum allowable case temperature $T_C = f(I_{FAVM})$

Strombelastung je Zweig / Current load per arm

Berechnungsgrundlage P_{TAV}
Calculation base P_{TAV}

Parameter: Stromflußwinkel Θ / Current conduction angle Θ

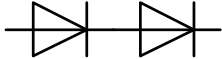

Netz-Dioden-Modul
Rectifier Diode Module

DD171N

Infineon Technologies Bipolar
GmbH & Co. KG

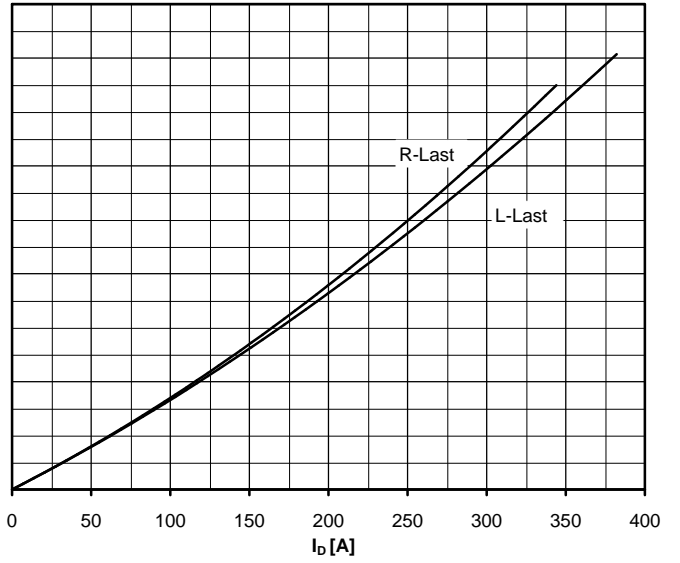
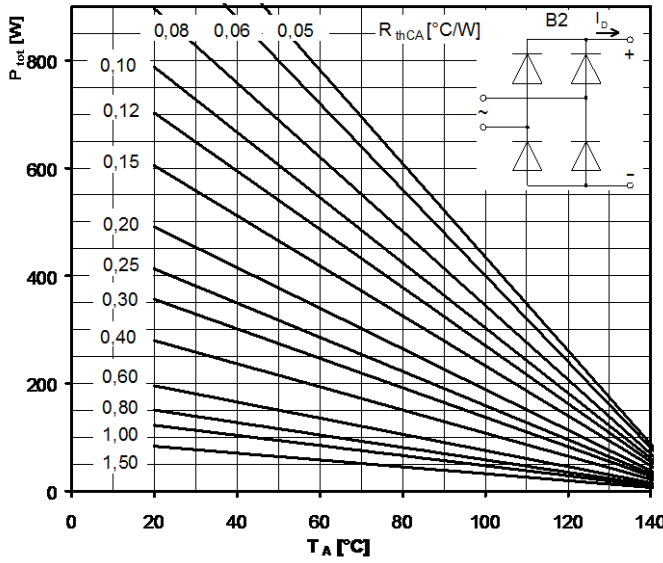

Höchstzulässiger Ausgangsstrom / Maximum rated output current I_D

B2- Zweipuls-Brückenschaltung / Two-pulse bridge circuit

Gesamtverlustleistung der Schaltung / Total power dissipation at circuit P_{tot}

Parameter:

Wärmewiderstand zwischen den Gehäusen und Umgebung / Thermal resistance cases to ambient R_{thCA}

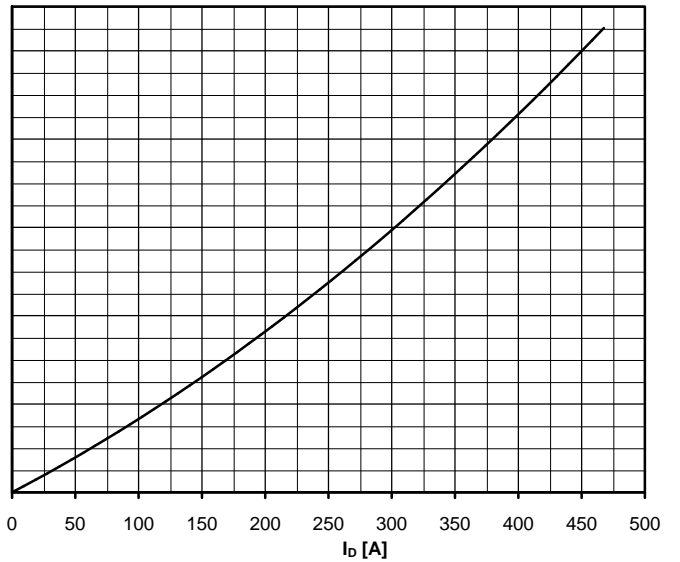
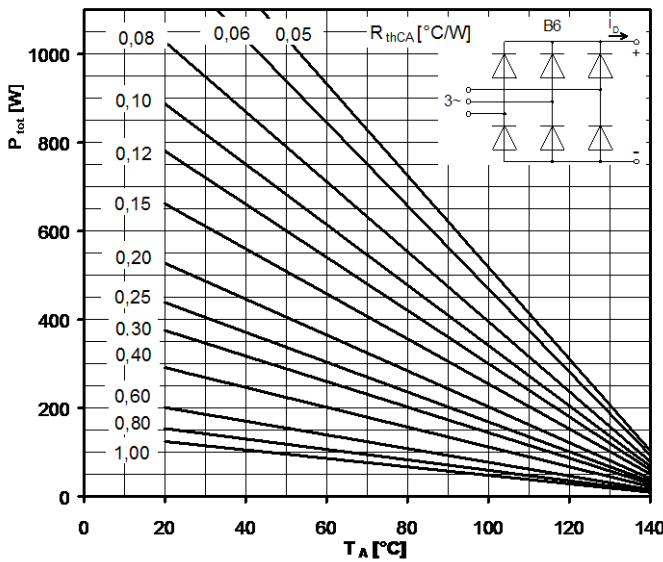

Höchstzulässiger Ausgangsstrom / Maximum rated output current I_D

B6- Sechspuls-Brückenschaltung / Six-pulse bridge circuit

Gesamtverlustleistung der Schaltung / Total power dissipation at circuit P_{tot}

Parameter:

Wärmewiderstand zwischen den Gehäusen und Umgebung / Thermal resistance cases to ambient R_{thCA}

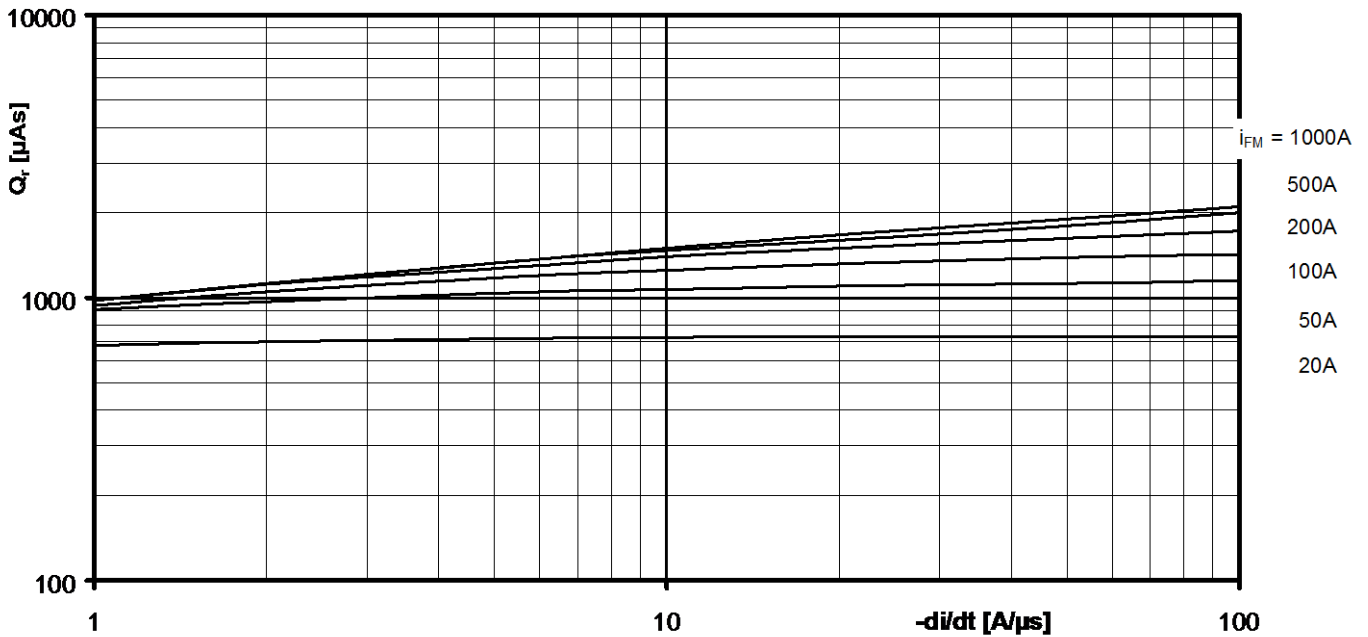
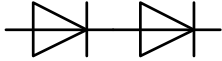

Sperrverzögerungsladung / Recovered charge $Q_r = f(-di/dt)$

$$T_{vj} = T_{vjmax}, V_R \leq 0,5 V_{RRM}, V_{RM} = 0,8 V_{RRM}$$

Parameter: Durchlaßstrom / On-state current i_{FM}

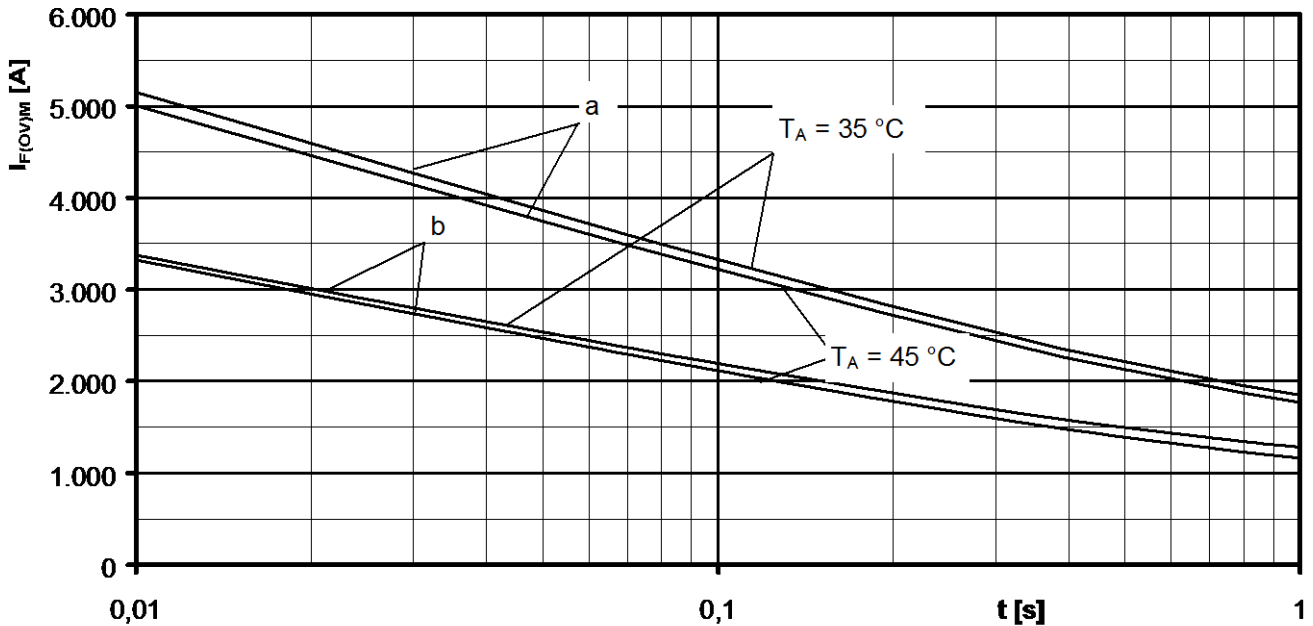

Grenzstrom je Zweig / Maximum overload on-state current per arm $I_{F(OV)M} = f(t), V_{RM} = 0,8 V_{RRM}$

a: Leerlauf / No-load conditions

b: Vorlaststrom je Zweig / Pre-load current per arm $I_{FAV(vor)} = I_{FAVM}$

$T_a = 35^\circ\text{C}$, verstärkte Luftkühlung / Forced air cooling Kühlkörper / Heatsink type: KM17 (Papst 4650)

$T_a = 45^\circ\text{C}$, natürliche Luftkühlung / Natural air cooling Kühlkörper / Heatsink type: KM17 (60W)