



Key Parameters

V_{RRM}	1600V
I_{FAVM}	226A ($T_C = 85^\circ\text{C}$)
I_{FSM}	5750A
V_{T0}	0,85V
r_T	0,95m Ω
R_{thJC}	0,14K/W
Base plate	34mm
Weight	165g



For type designation please refer to actual short form catalog

<http://www.ifbip.com/catalog>

Merkmale

- Löt-Bond Technologie
- Industrie-Standard-Gehäuse
- Elektrisch isolierte Bodenplatte

Features

- Solder-Bond Technology
- Industrial standard package
- Electrically insulated base plate

Typische Anwendungen

- Gleichrichter für Antriebsapplikationen
- Gleichrichter für UPS
- Batterieladegleichrichter

Typical Applications

- Rectifier for drives applications
- Rectifiers for UPS
- Battery chargers

	DMX code digit	DMX code digit quantity
content of customer DMX code	1..18	18
type designation	19..23	5
serial number	24..31	8
material number	32..41	10
date code (YY/WW)	42..45	4
add on for date code	46	1

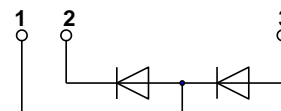

www.ifbip.com
support@infineon-bip.com



Technische Information / technical information



Netz-Dioden-Modul
Rectifier Diode Module

DD180N16S

Infineon Technologies Bipolar
GmbH & Co. KG

Elektrische Eigenschaften / Electrical properties

Höchstzulässige Werte / Maximum rated values

Periodische Spitzensperrspannung repetitive peak reverse voltages	$T_{vj} = -40^{\circ}\text{C} \dots T_{vj\text{max}}$	V_{RRM}	1600	V
Stoßspitzensperrspannung non-repetitive peak reverse voltage	$T_{vj} = +25^{\circ}\text{C} \dots T_{vj\text{max}}$	V_{RSM}	1700	V
Durchlaßstrom-Grenzeffektivwert maximum RMS on-state current		I_{FRMSM}	275	A
Dauergrenzstrom average on-state current	$T_C = 85^{\circ}\text{C}$ $T_C = 100^{\circ}\text{C}$	I_{FAVM}	226 174	A A
Stoßstrom-Grenzwert surge current	$T_{vj} = 25^{\circ}\text{C}, t_p = 10\text{ms}$ $T_{vj} = T_{vj\text{max}}, t_p = 10\text{ms}$	I_{FSM}	5750 5000	A A
Grenzlastintegral I^2t -value	$T_{vj} = 25^{\circ}\text{C}, t_p = 10\text{ms}$ $T_{vj} = T_{vj\text{max}}, t_p = 10\text{ms}$	I^2t	165313 125000	A ² s A ² s

Charakteristische Werte / Characteristic values

Durchlaßspannung on-state voltage	$T_{vj} = T_{vj\text{max}}, I_F = 500\text{A}$	V_F	max. 1,39	V
Schleusenspannung threshold voltage	$T_{vj} = T_{vj\text{max}}$	$V_{(TO)}$	max. 0,85	V
Ersatzwiderstand slope resistance	$T_{vj} = T_{vj\text{max}}$	r_T	max. 0,95	mΩ
Sperrstrom reverse current	$T_{vj} = T_{vj\text{max}}, V_R = V_{RRM}$	i_R	max. 1	mA
Isolations-Prüfspannung insulation test voltage	RMS, $f = 50\text{Hz}, t = 1\text{ sec}$ RMS, $f = 50\text{Hz}, t = 1\text{ min}$	V_{ISOL}	3,6 3	kV kV

Thermische Eigenschaften / Thermal properties

Innerer Wärmewiderstand thermal resistance, junction to case	pro Modul / per Module, $\Theta = 180^{\circ}\text{ sin}$ pro Zweig / per arm, $\Theta = 180^{\circ}\text{ sin}$	R_{thJC}	max. 0,08	K/W
			max. 0,16	K/W
	pro Modul / per Module, DC pro Zweig / per arm, DC		max. 0,07	K/W
			max. 0,14	K/W
Übergangs-Wärmewiderstand thermal resistance, case to heatsink	pro Modul / per Module pro Zweig / per arm	R_{thCH}	max. 0,04	K/W
			max. 0,08	K/W
Höchstzulässige Sperrschichttemperatur maximum junction temperature		$T_{vj\text{max}}$	135	°C
Betriebstemperatur operating temperature		$T_{c\text{op}}$	- 40...+135	°C
Lagertemperatur storage temperature		T_{stg}	- 40...+135	°C

prepared by: AG		date of publication: 2017-08-24
approved by: MS		revision: 3.3

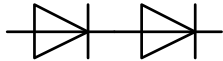

Technische Information /
technical information



Netz-Dioden-Modul
Rectifier Diode Module

DD180N16S

Infineon Technologies Bipolar
GmbH & Co. KG

Mechanische Eigenschaften / Mechanical properties

Gehäuse, siehe Anlage case, see annex			Seite 4 page 4	
Innere Isolation internal insulation	Basisisolierung (Schutzklasse 1, EN 61140) Basic insulation (class 1, IEC 61140)		Al ₂ O ₃	
Anzugsdrehmoment für mechanische Anschlüsse mounting torque	Toleranz ±15%	M1	5	Nm
Anzugsdrehmoment für elektrische Anschlüsse terminal connection torque	Toleranz ±10%	M2	5	Nm
Gewicht weight		G	typ. 165	g
Kriechstrecke creepage distance			10	mm
Schwingfestigkeit vibration resistance	f = 50Hz		50	m/s ²
	file-No.		E 83335	

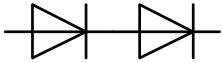

Technische Information /
technical information



Netz-Dioden-Modul
Rectifier Diode Module

DD180N16S

Infineon Technologies Bipolar
GmbH & Co. KG

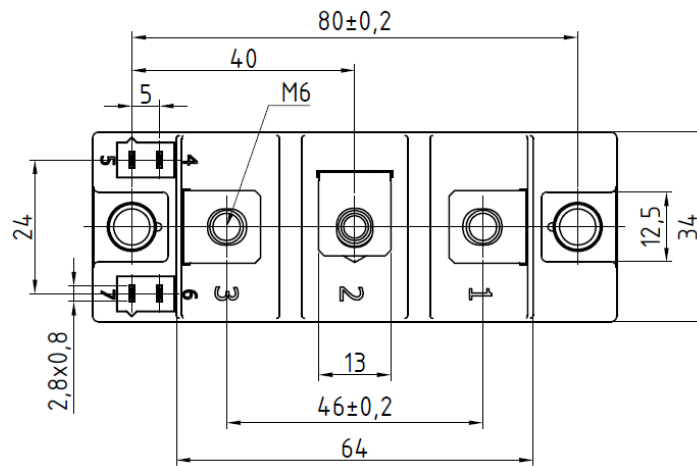
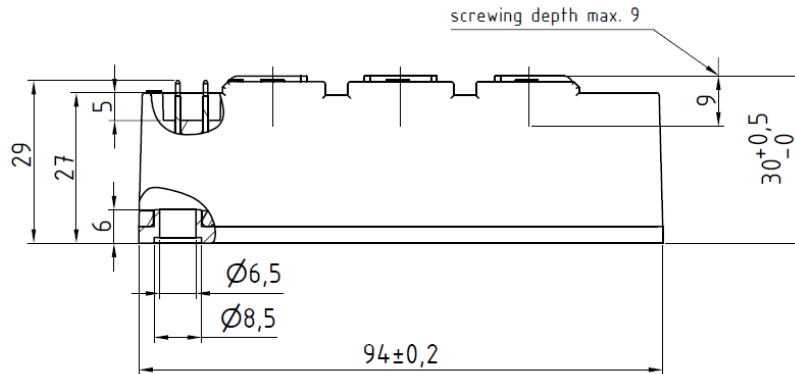

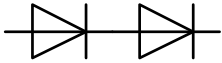

Analytische Elemente des transienten Wärmewiderstandes Z_{thJC} für DC
Analytical elements of transient thermal impedance Z_{thJC} for DC

Pos. n	1	2	3	4	5	6	7
R_{thn} [K/W]	0,0624	0,0024648	0,0674976	0,0076896			
τ_n [s]	0,035107	0,035092	0,034917	0,001473			

Analytische Funktion / Analytical function:

$$Z_{thJC} = \sum_{n=1}^{n_{max}} R_{thn} \left(1 - e^{-\frac{t}{\tau_n}} \right)$$

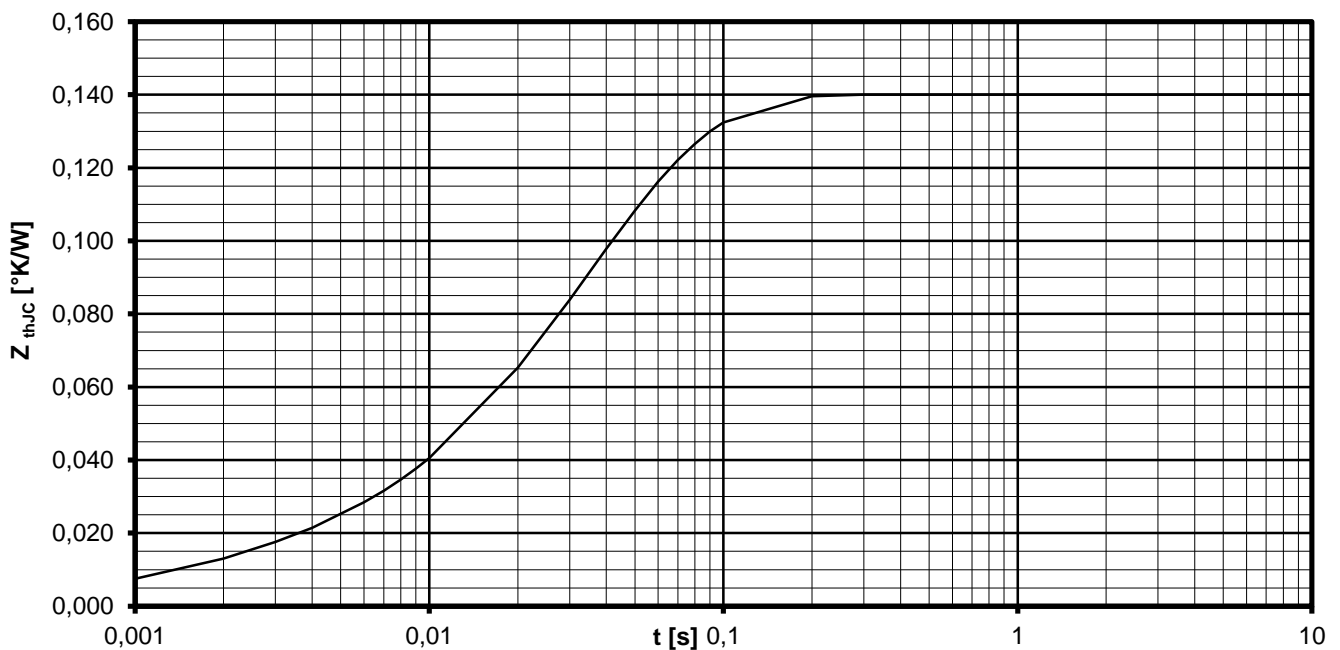

Transienter innerer Wärmewiderstand je Zweig / Transient thermal impedance per arm $Z_{thJC} = f(t)$

Parameter: Stromflußwinkel Θ / Current conduction angle Θ



Erhöhung des $Z_{th DC}$ bei Sinus und Rechteckströmen mit unterschiedlichen Stromflusswinkeln Θ
Rise of $Z_{th DC}$ for sinewave and rectangular current with different current conduction angles Θ
 $\Delta Z_{th \Theta rec} / \Delta Z_{th \Theta sin}$

	$\Theta = 180^\circ$	$\Theta = 120^\circ$	$\Theta = 90^\circ$	$\Theta = 60^\circ$	$\Theta = 30^\circ$
$\Delta Z_{th \Theta rec}$ [K/W]	0,02645	0,04099	0,05159	0,06706	0,09217
$\Delta Z_{th \Theta sin}$ [K/W]	0,02007	0,0323	0,04668	0,06381	0,09023

$$Z_{th \Theta rec} = Z_{th DC} + \Delta Z_{th \Theta rec}$$
$$Z_{th \Theta sin} = Z_{th DC} + \Delta Z_{th \Theta sin}$$

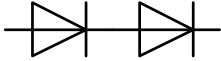

Durchlassverlustleistung je Zweig / On-state power loss per arm $P_{FAV} = f(I_{FAV})$

Parameter: Stromflußwinkel / Current conduction angle Θ

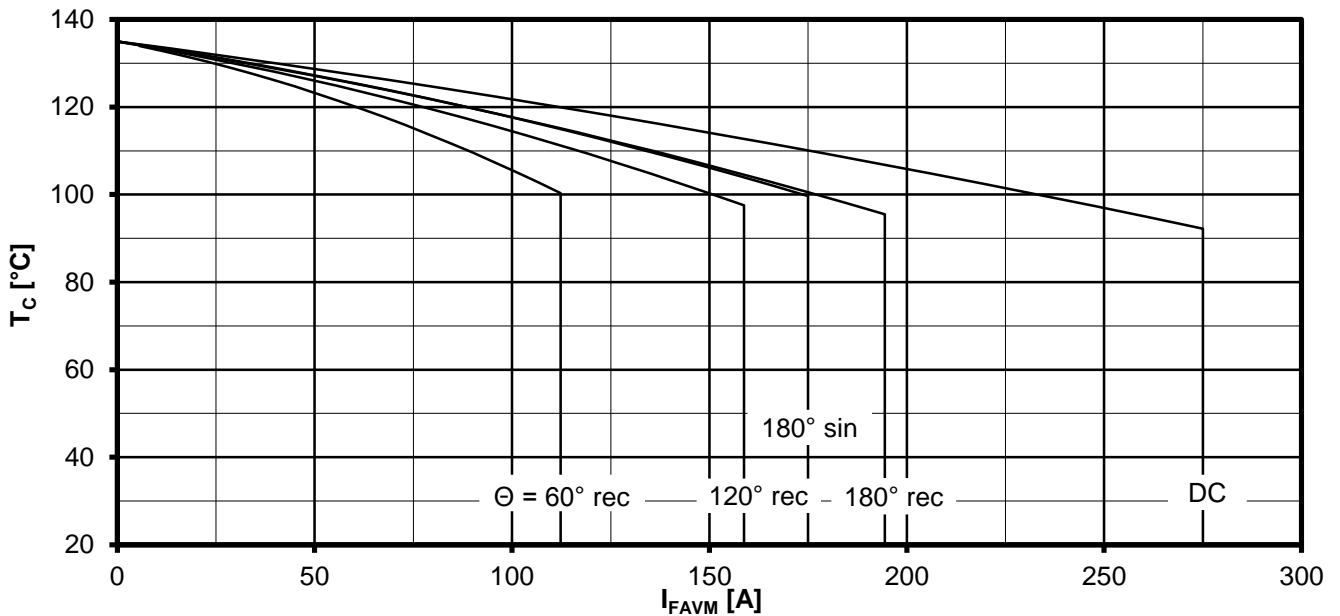

Höchstzulässige Gehäusetemperatur / Maximum allowable case temperature $T_C = f(I_{FAVM})$

Strombelastung je Zweig / Current load per arm

Berechnungsgrundlage P_{TAV}
Calculation base P_{TAV}

Parameter: Stromflußwinkel Θ / Current conduction angle Θ

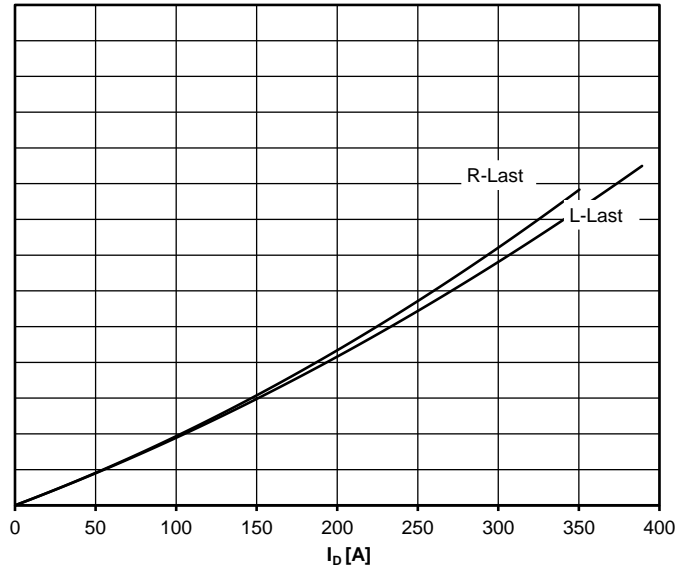
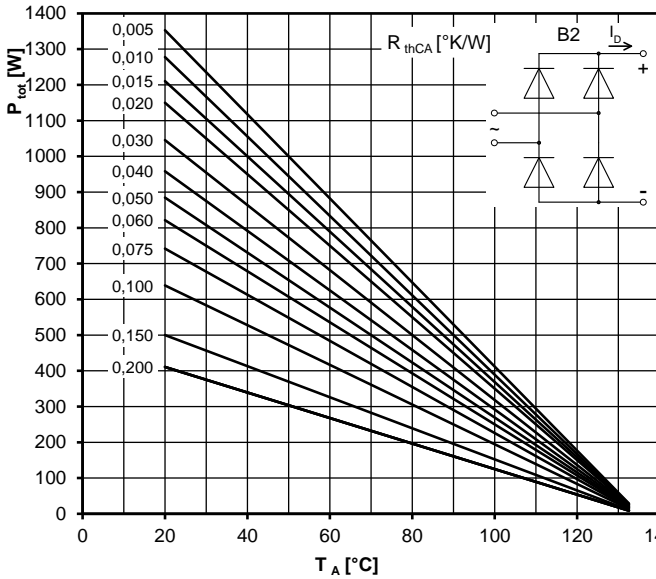
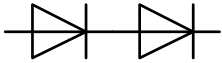

Höchstzulässiger Ausgangsstrom / Maximum rated output current I_b

B2- Zweipuls-Brückenschaltung / Two-pulse bridge circuit

Gesamtverlustleistung der Schaltung / Total power dissipation at circuit P_{tot}

Parameter:

Wärmewiderstand zwischen den Gehäusen und Umgebung / Thermal resistance cases to ambient R_{thCA}

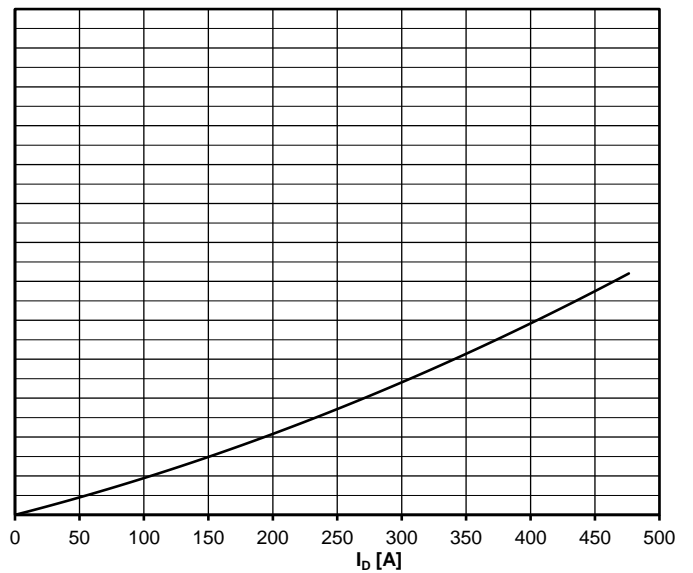
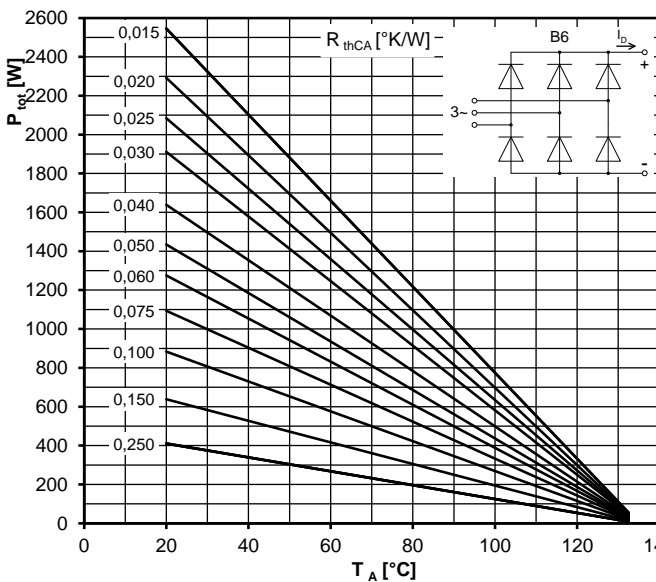

Höchstzulässiger Ausgangsstrom / Maximum rated output current I_b

B6- Sechspuls-Brückenschaltung / Six-pulse bridge circuit

Gesamtverlustleistung der Schaltung / Total power dissipation at circuit P_{tot}

Parameter:

Wärmewiderstand zwischen den Gehäusen und Umgebung / Thermal resistance cases to ambient R_{thCA}

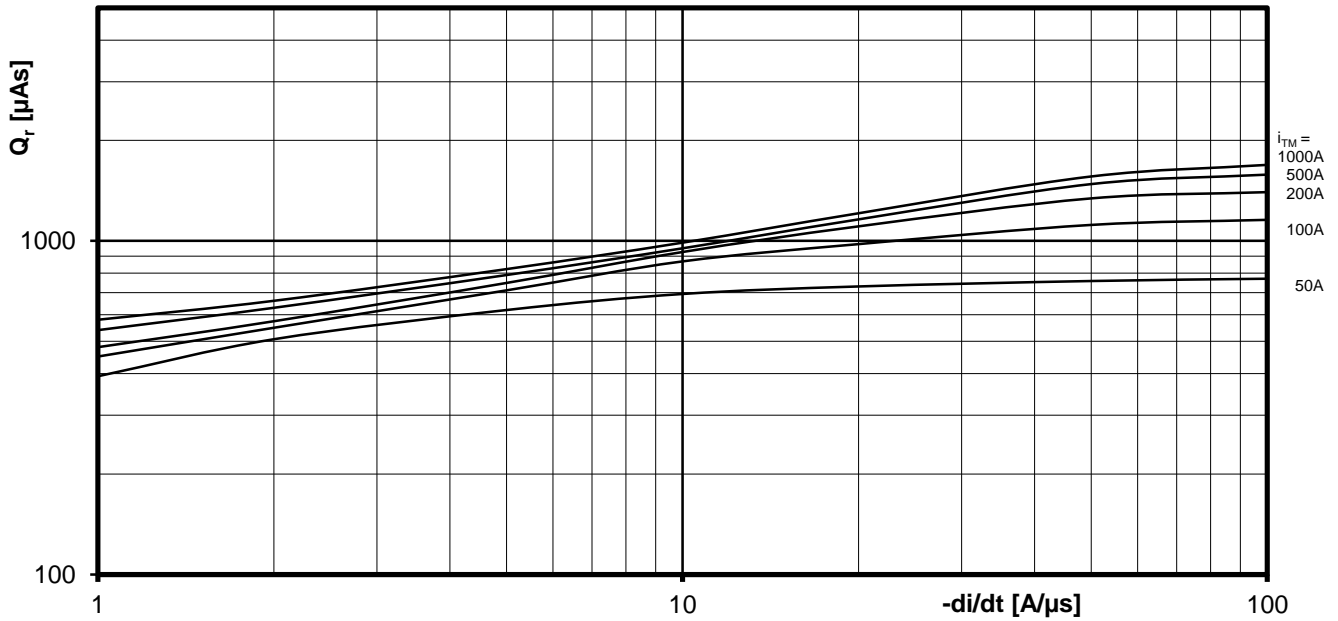

Sperrverzögerungsladung / Recovered charge $Q_r = f(-di/dt)$

$$T_{vj} = T_{vjmax}, V_R \leq 0,5 V_{RRM}, V_{RM} = 0,8 V_{RRM}$$

Parameter: Durchlaßstrom / On-state current i_{FM}

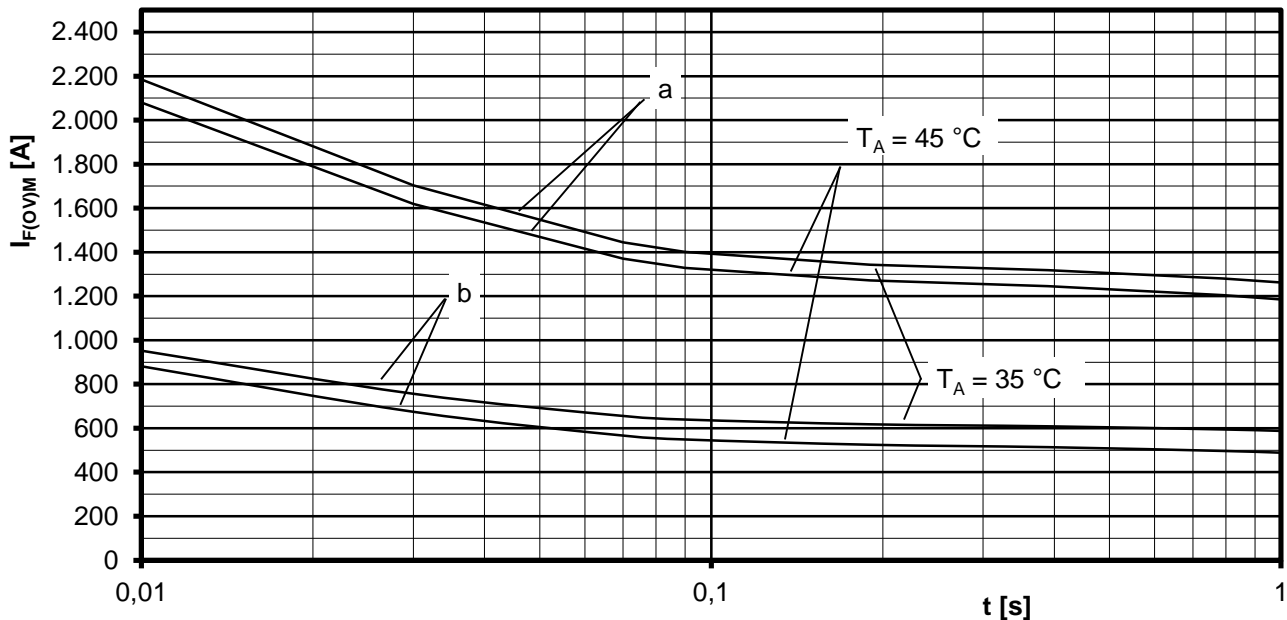

Grenzstrom je Zweig / Maximum overload on-state current per arm $I_{F(OV)M} = f(t), V_{RM} = 0,8 V_{RRM}$

a: Leerlauf / No-load conditions

b: Vorlaststrom je Zweig / Pre-load current per arm $I_{FAV(vor)} = I_{FAVM}$

$T_a = 35^\circ\text{C}$, verstärkte Luftkühlung / Forced air cooling Kühlkörper / Heatsink type: KM17 (Papst 4650)

$T_a = 45^\circ\text{C}$, natürliche Luftkühlung / Natural air cooling Kühlkörper / Heatsink type: KM17 (60W)