



Key Parameters

V_{DRM} / V_{RRM}	2000 - 2500 V
I_{FAVM}	98 A ($T_C=100\text{ }^\circ\text{C}$)
I_{FSM}	2400 A
V_{T0}	0,82 V
r_T	2,0 m Ω
R_{thJC}	0,185 K/W
Base plate	20 mm
Weight	160 g



For type designation please refer to actual short form catalog

<http://www.ifbip.com/catalog>

Merkmale

- Druckkontakt-Technologie für hohe Zuverlässigkeit
- Industrie-Standard-Gehäuse
- Elektrisch isolierte Bodenplatte

Features

- Pressure contact technology for high reliability
- Industrial standard package
- Electrically insulated base plate

Typische Anwendungen

- Gleichrichter für Antriebsapplikationen
- Gleichrichter für UPS
- Batterieladegleichrichter

Typical Applications

- Rectifier for drives applications
- Rectifiers for UPS
- Battery chargers

content of customer DMX code	DMX code	
	digit	digit quantity
type designation	1..18	18
serial number	19..23	5
internal production order number	24..31	8
material number	32..41	10
date code (YY/WW)	42..45	4
add on for date code	46	1



www.ifbip.com
support@infineon-bip.com



Datenblatt / Data sheet



Netz-Dioden-Modul
Rectifier Diode Module

DD98N

Infineon Technologies Bipolar
GmbH & Co. KG

DD98N

DD98N..K..-K

Elektrische Eigenschaften / Electrical properties

Höchstzulässige Werte / Maximum rated values

Periodische Spitzensperrspannung repetitive peak reverse voltages	$T_{vj} = -40^{\circ}\text{C} \dots T_{vj \text{ max}}$	V_{RRM}	2000 2400	2200 2500	V V
Stoßspitzensperrspannung non-repetitive peak reverse voltage	$T_{vj} = +25^{\circ}\text{C} \dots T_{vj \text{ max}}$	V_{RSM}	2100 2500	2300 2600	V V
Durchlaßstrom-Grenzeffektivwert maximum RMS on-state current		I_{FRMSM}		160	A
Dauergrenzstrom average on-state current	$T_C = 100^{\circ}\text{C}$	I_{FAVM}		98	A
Stoßstrom-Grenzwert surge current	$T_{vj} = 25^{\circ}\text{C}, t_p = 10 \text{ ms}$ $T_{vj} = T_{vj \text{ max}}, t_p = 10 \text{ ms}$	I_{FSM}		2.400 2.000	A A
Grenzlastintegral I^2t -value	$T_{vj} = 25^{\circ}\text{C}, t_p = 10 \text{ ms}$ $T_{vj} = T_{vj \text{ max}}, t_p = 10 \text{ ms}$	I^2t		28.800 20.000	A ² s A ² s

Charakteristische Werte / Characteristic values

Durchlaßspannung on-state voltage	$T_{vj} = T_{vj \text{ max}}, I_F = 300 \text{ A}$	V_F	max.	1,53	V
Schleusenspannung threshold voltage	$T_{vj} = T_{vj \text{ max}}$	$V_{(TO)}$		0,82	V
Ersatzwiderstand slope resistance	$T_{vj} = T_{vj \text{ max}}$	r_T		2	mΩ
Sperrstrom reverse current	$T_{vj} = T_{vj \text{ max}}, V_R = V_{RRM}$	i_R	max.	25	mA
Isolations-Prüfspannung insulation test voltage	RMS, $f = 50 \text{ Hz}, t = 1 \text{ sec}$ RMS, $f = 50 \text{ Hz}, t = 1 \text{ min}$	V_{ISOL}		3,0 2,5	kV kV

Thermische Eigenschaften / Thermal properties

Innerer Wärmewiderstand thermal resistance, junction to case	pro Modul / per Module, $\Theta = 180^{\circ} \text{ sin}$ pro Zweig / per arm, $\Theta = 180^{\circ} \text{ sin}$ pro Modul / per Module, DC pro Zweig / per arm, DC	R_{thJC}	max.	0,195 0,390 0,185 0,370	°C/W °C/W °C/W °C/W
Übergangs-Wärmewiderstand thermal resistance, case to heatsink	pro Modul / per Module pro Zweig / per arm	R_{thCH}	max.	0,05 0,10	°C/W °C/W
Höchstzulässige Sperrschichttemperatur maximum junction temperature		$T_{vj \text{ max}}$		150	°C
Betriebstemperatur operating temperature		$T_{c \text{ op}}$		- 40...+150	°C
Lagertemperatur storage temperature		T_{stg}		- 40...+150	°C

prepared by:	A.G.	date of publication:	23.05.2016
approved by:	M. S.	revision:	3.2

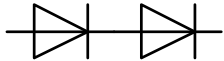

Datenblatt / Data sheet



Netz-Dioden-Modul
Rectifier Diode Module

DD98N

Infineon Technologies Bipolar
GmbH & Co. KG

Mechanische Eigenschaften / Mechanical properties

Gehäuse, siehe Anlage case, see annex			Seite 4 page 4	
Si-Element mit Druckkontakt Si-pellet with pressure contact				
Innere Isolation internal insulation			AIN	
Anzugsdrehmoment für mechanische Anschlüsse mounting torque	Toleranz $\pm 15\%$	M1	4	Nm
Anzugsdrehmoment für elektrische Anschlüsse terminal connection torque	Toleranz $\pm 10\%$	M2	4	Nm
Gewicht weight		G	typ. 160	g
Kriechstrecke creepage distance			15	mm
Schwingfestigkeit vibration resistance	f = 50 Hz		50	m/s ²
	file-No.		E 83335	



Datenblatt / Data sheet



Netz-Dioden-Modul
Rectifier Diode Module

DD98N

Infineon Technologies Bipolar
GmbH & Co. KG

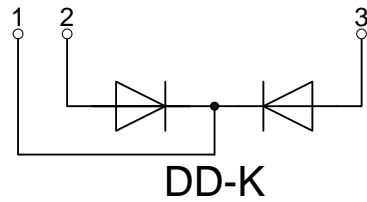
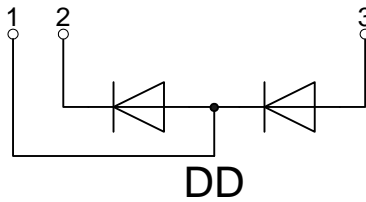
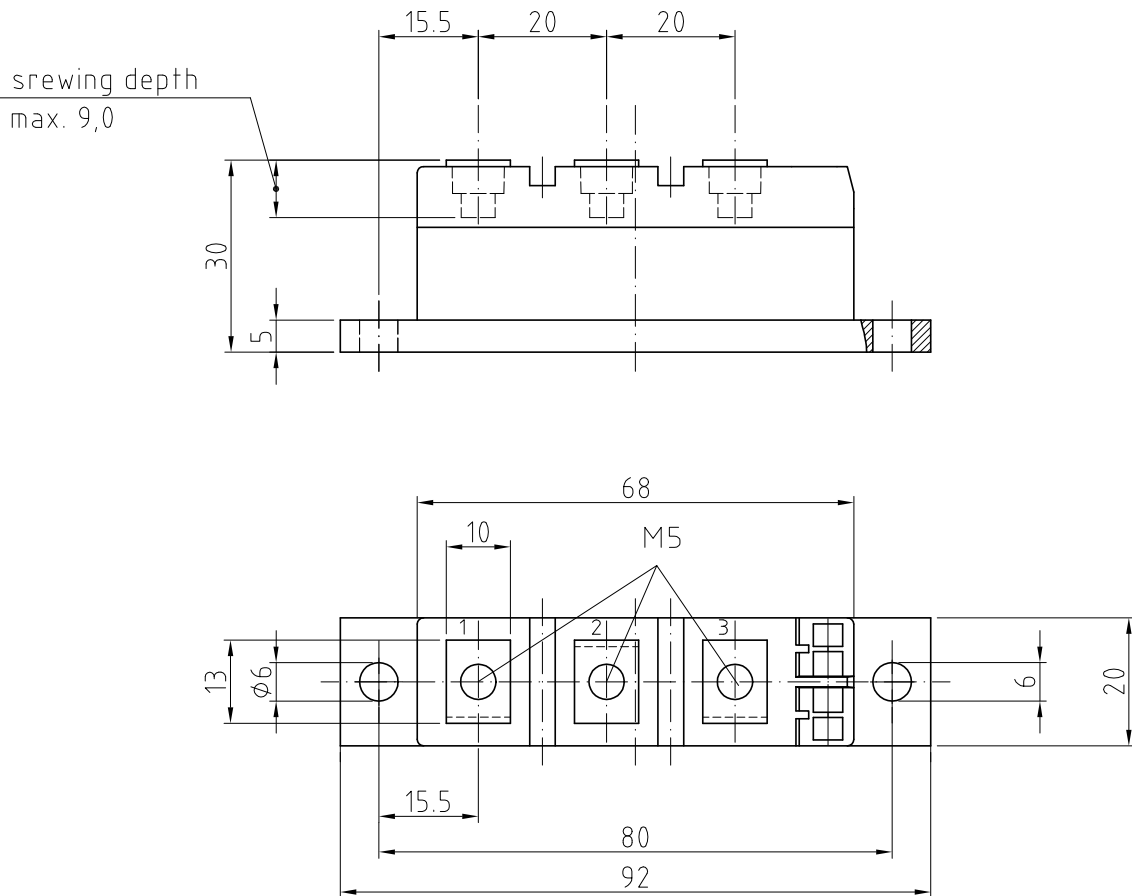



Analytische Elemente des transienten Wärmewiderstandes Z_{thJC} für DC
Analytical elements of transient thermal impedance Z_{thJC} for DC

Pos. n	1	2	3	4	5	6	7
R_{thn} [°C/W]	0,0233	0,0433	0,134	0,17			
T_n [s]	0,00137	0,0175	0,325	2,11			

Analytische Funktion / Analytical function:

$$Z_{thJC} = \sum_{n=1}^{n_{max}} R_{thn} \left(1 - e^{-\frac{t}{T_n}} \right)$$

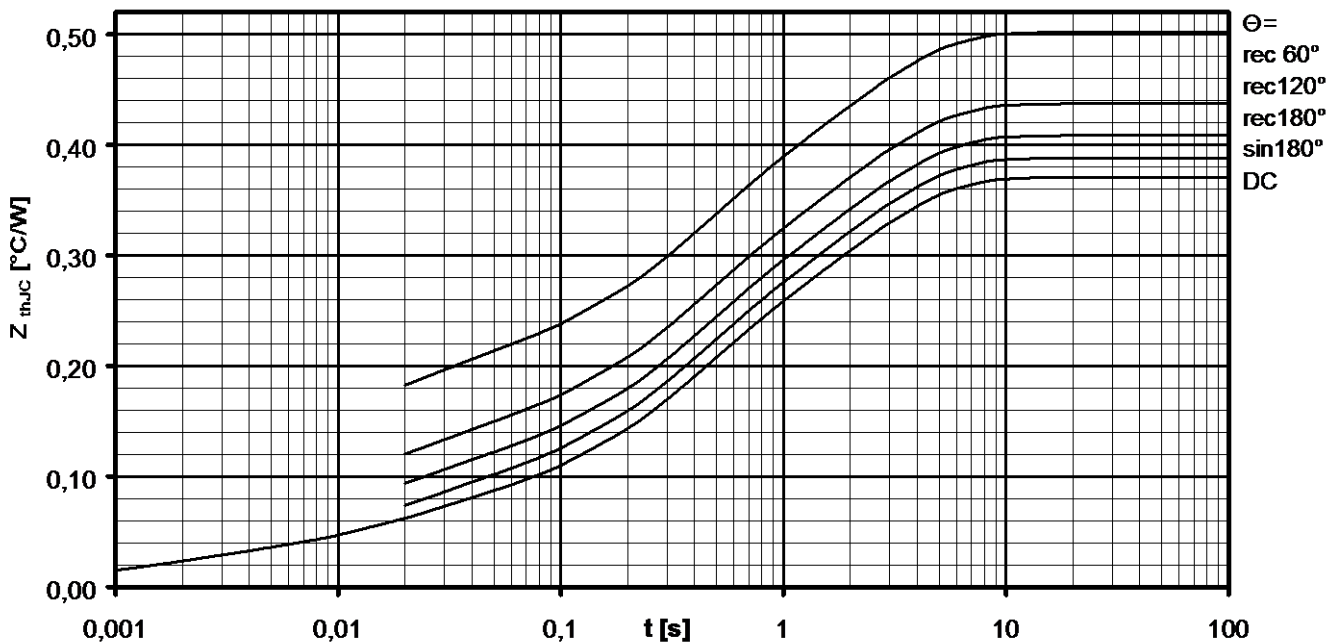

Transienter innerer Wärmewiderstand je Zweig / Transient thermal impedance per arm $Z_{thJC} = f(t)$

Parameter: Stromflußwinkel Θ / Current conduction angle Θ

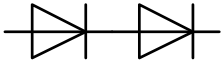

Natürliche Kühlung / Natural cooling
3 Module pro Kühler / 3 modules per heatsink
Kühler / Heatsink type: KM14 (50W)

Analytische Elemente des transienten Wärmewiderstandes Z_{thCA}
Analytical elements of transient thermal impedance Z_{thCA}

Pos. n	1	2	3	4	5	6	7
R_{thn} [°C/W]	0,007	0,141	0,119	2,133			
T_n [s]	0,701	4,72	42,5	910			

Verstärkte Kühlung / Forced cooling
3 Module pro Kühler / 3 modules per heatsink
Kühler / Heatsink type: KM14 (Papst 4650)

Analytische Elemente des transienten Wärmewiderstandes Z_{thCA}
Analytical elements of transient thermal impedance Z_{thCA}

Pos. n	1	2	3	4	5	6	7
R_{thn} [°C/W]	0,007	0,141	0,119	0,583			
T_n [s]	0,701	4,72	42,5	249			

Analytische Funktion / Analytical function:

$$Z_{thCA} = \sum_{n=1}^{n_{max}} R_{thn} \left(1 - e^{-\frac{t}{T_n}} \right)$$



Netz-Dioden-Modul
Rectifier Diode Module

DD98N

Infineon Technologies Bipolar
GmbH & Co. KG

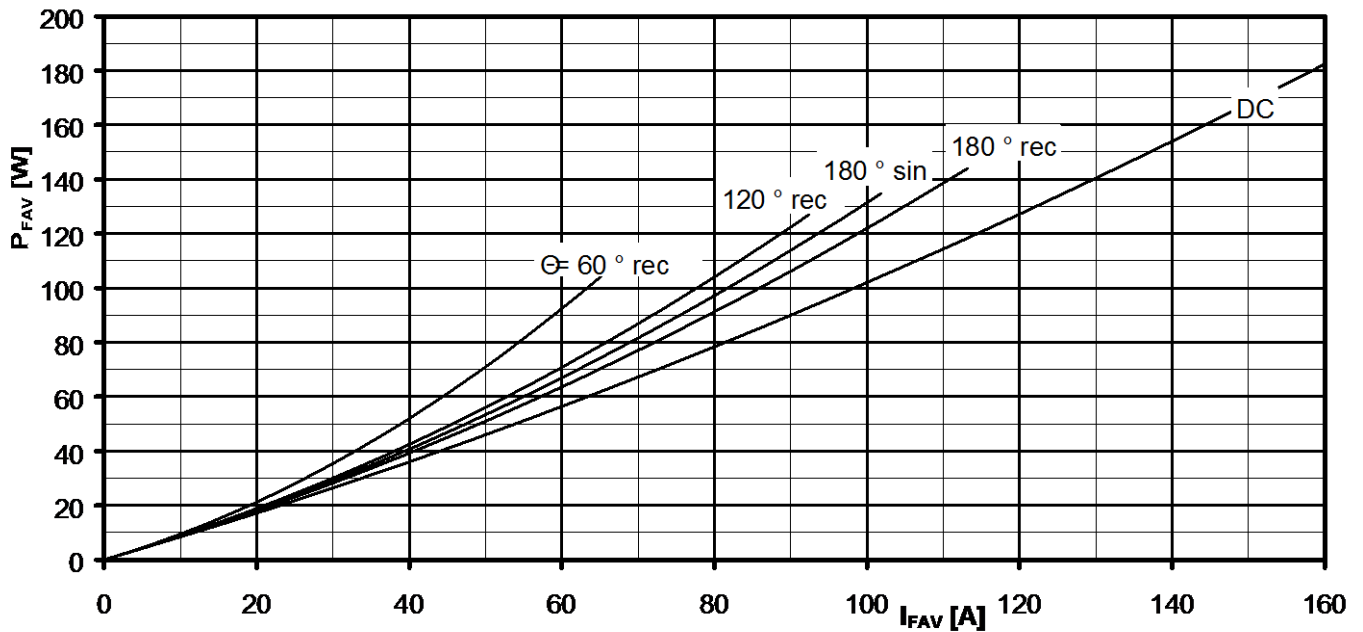

Durchlassverlustleistung je Zweig / On-state power loss per arm $P_{FAV} = f(I_{FAV})$

Parameter: Stromflußwinkel / Current conduction angle Θ

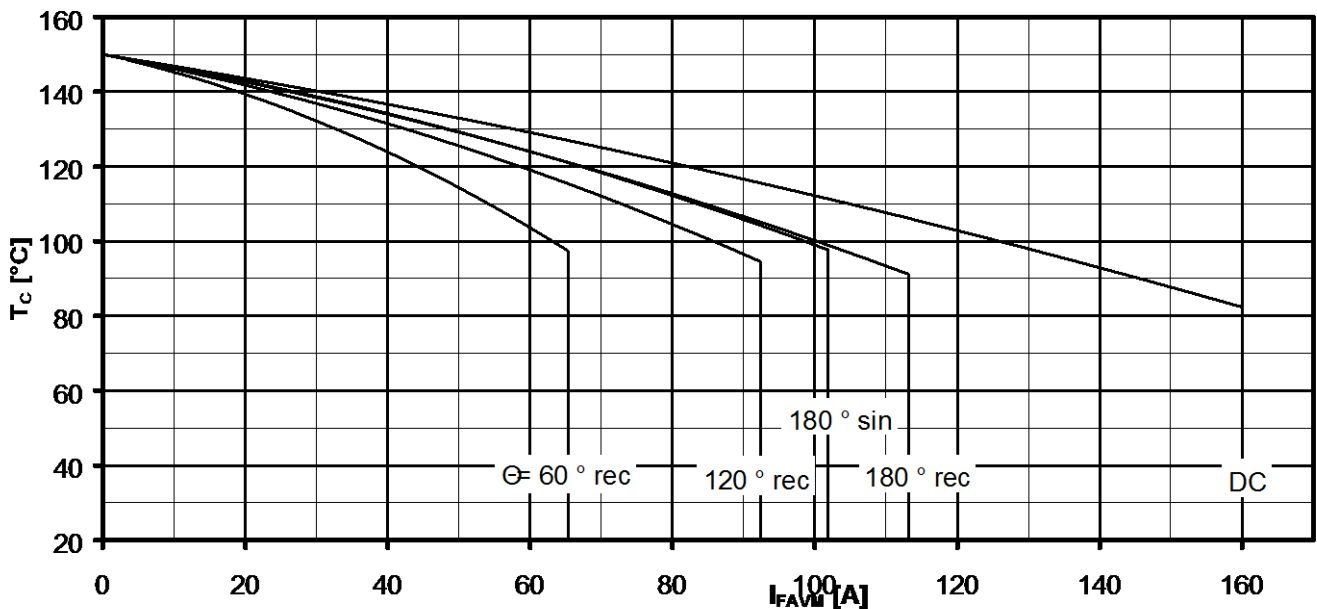

Höchstzulässige Gehäusetemperatur / Maximum allowable case temperature $T_C = f(I_{FAVM})$

Strombelastung je Zweig / Current load per arm

Berechnungsgrundlage P_{TAV} (Schaltverluste gesondert berücksichtigen)
Calculation base P_{TAV} (switching losses should be considered separately)

Parameter: Stromflußwinkel Θ / Current conduction angle Θ



Netz-Dioden-Modul
Rectifier Diode Module

DD98N

Infineon Technologies Bipolar
GmbH & Co. KG

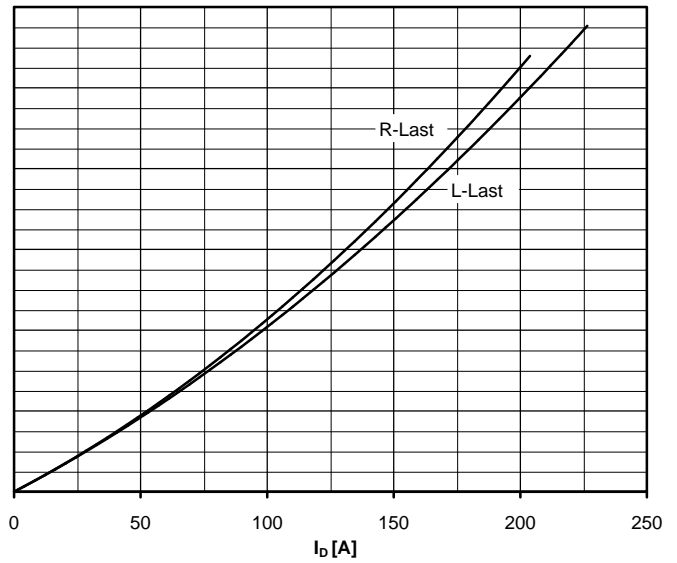
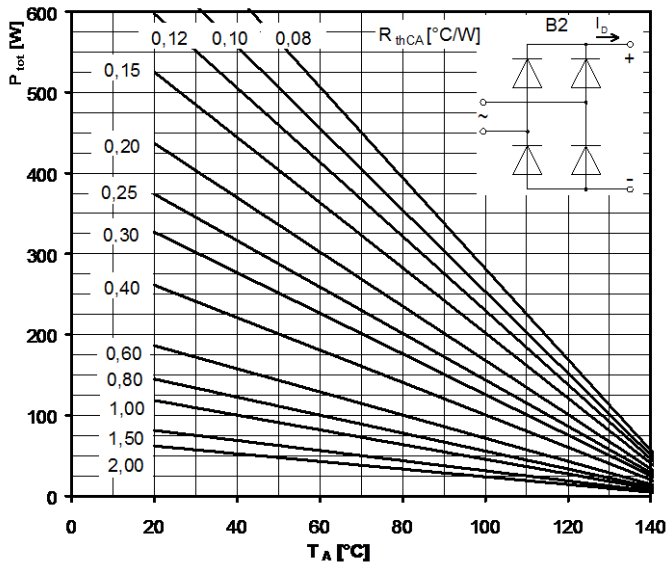

Höchstzulässiger Ausgangsstrom / Maximum rated output current I_D

B2- Zweipuls-Brückenschaltung / Two-pulse bridge circuit

Gesamtverlustleistung der Schaltung / Total power dissipation at circuit P_{tot}

Parameter:

Wärmewiderstand zwischen den Gehäusen und Umgebung / Thermal resistance cases to ambient R_{thCA}

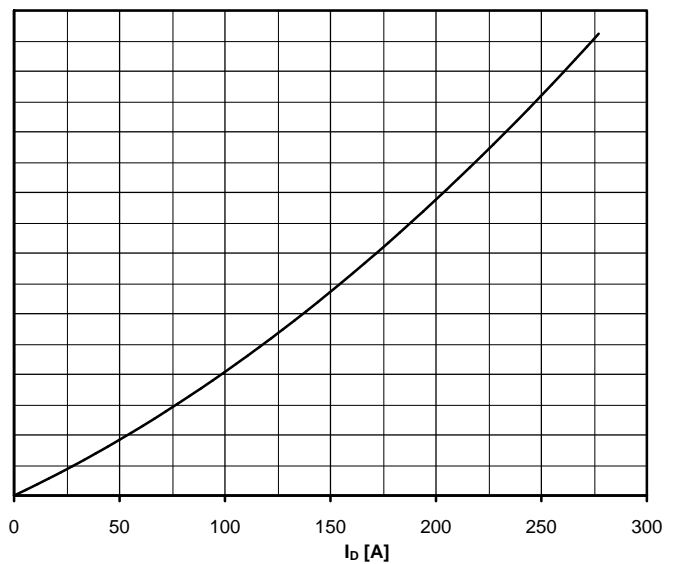
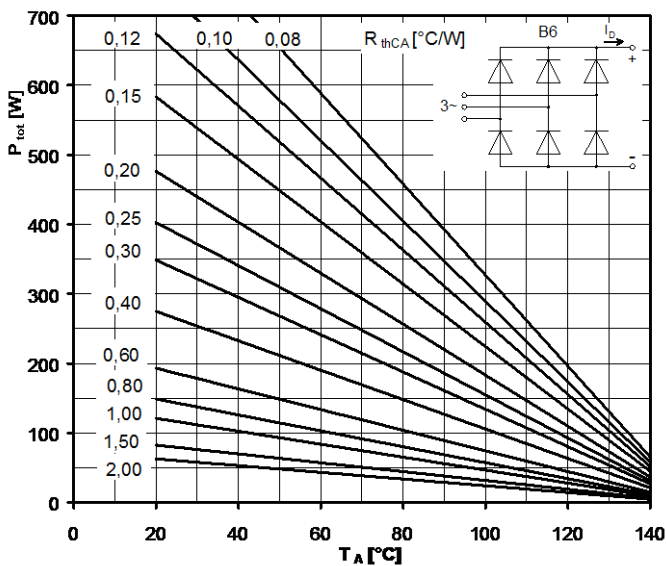

Höchstzulässiger Ausgangsstrom / Maximum rated output current I_D

B6- Sechspuls-Brückenschaltung / Six-pulse bridge circuit

Gesamtverlustleistung der Schaltung / Total power dissipation at circuit P_{tot}

Parameter:

Wärmewiderstand zwischen den Gehäusen und Umgebung / Thermal resistance cases to ambient R_{thCA}

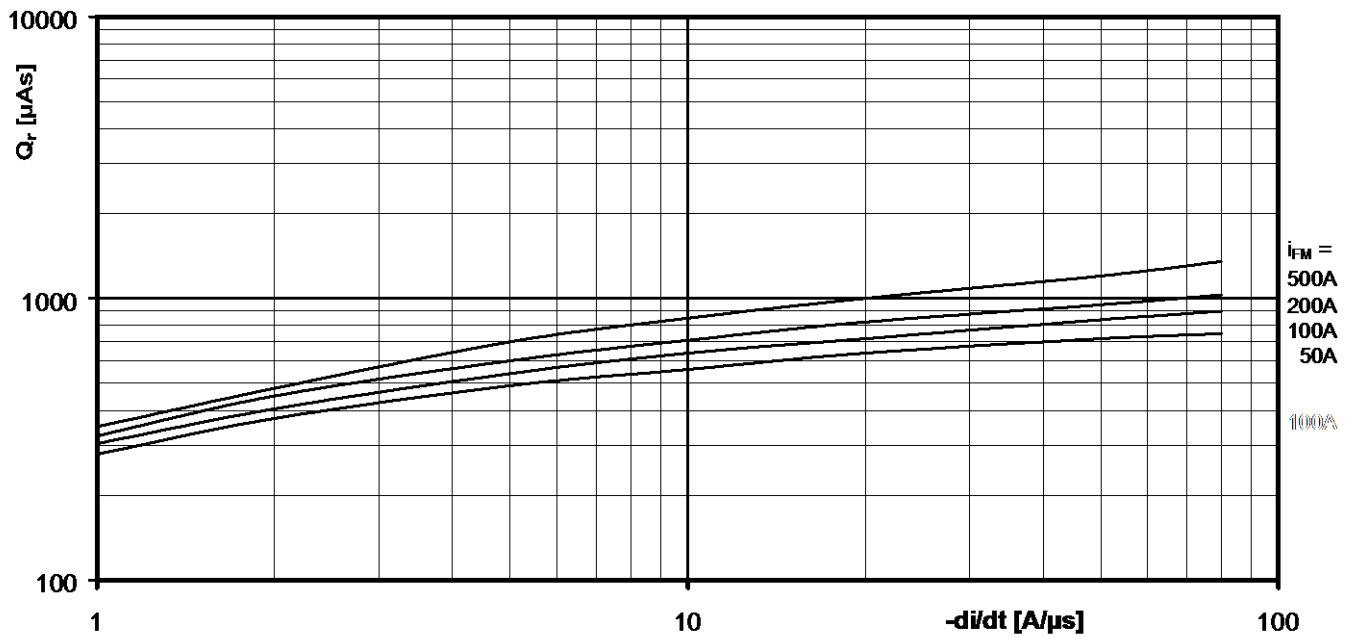

Sperrverzögerungsladung / Recovered charge $Q_r = f(-di/dt)$

$$T_{vj} = T_{vjmax}, V_R \leq 0,5 V_{RRM}, V_{RM} = 0,8 V_{RRM}$$

Parameter: Durchlaßstrom / On-state current i_{FM}

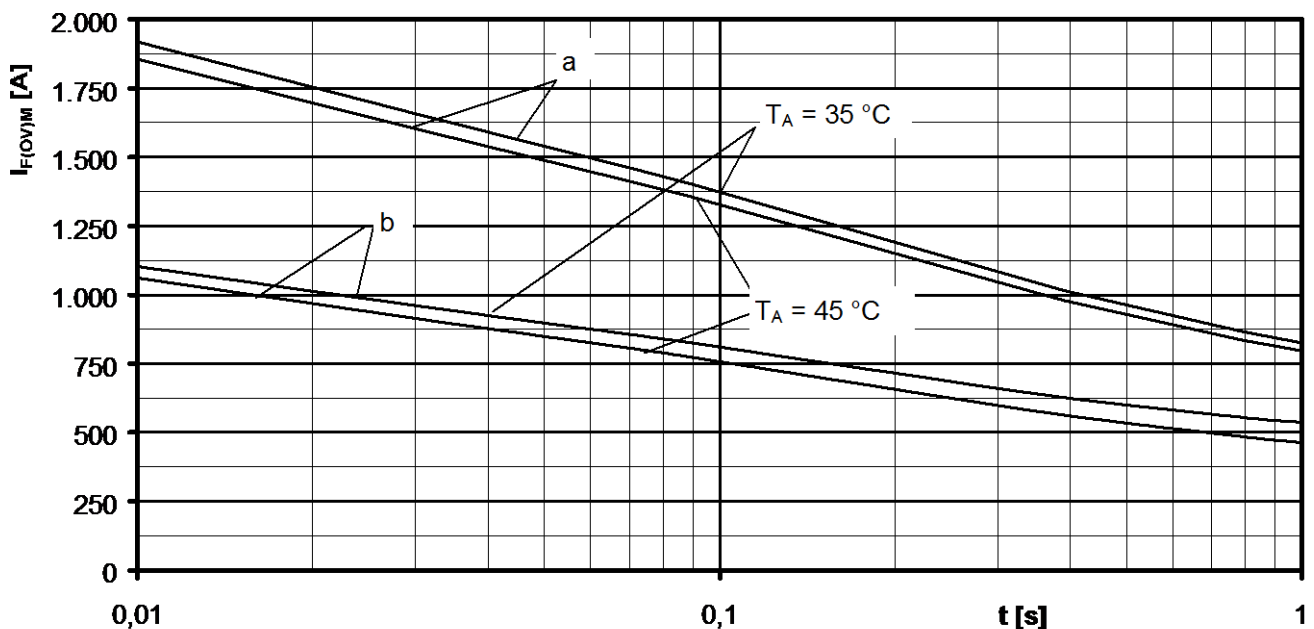

Grenzstrom je Zweig / Maximum overload on-state current per arm $I_{F(OV)M} = f(t), V_{RM} = 0,8 V_{RRM}$

a: Leerlauf / No-load conditions

b: Vorlaststrom je Zweig / Pre-load current per arm $I_{FAV(vor)} = I_{FAVM}$

$T_a = 35^\circ\text{C}$, verstärkte Luftkühlung / Forced air cooling Kühlkörper / Heatsink type: KM14 (Papst 4650)

$T_a = 45^\circ\text{C}$, natürliche Luftkühlung / Natural air cooling Kühlkörper / Heatsink type: KM14 (50W)