

**PNP PRE-BIASED SMALL SIGNAL DUAL SURFACE MOUNT TRANSISTOR**
**Features**

- Epitaxial Planar Die Construction
- Complementary NPN Types Available (DDC)
- Built-In Biasing Resistors
- **Totally Lead-Free & Fully RoHS Compliant (Notes 1 & 2)**
- **Halogen and Antimony Free. "Green" Device (Note 3)**
- **Qualified to AEC-Q101 Standards for High Reliability**
- **PPAP Capable (Note 4)**

Part Number	R1 (NOM)	R2 (NOM)
DDA124EU	22kΩ	22kΩ
DDA144EU	47kΩ	47kΩ
DDA114YU	10kΩ	47kΩ
DDA123JU	2.2kΩ	47kΩ
DDA114EU	10kΩ	10kΩ

**Mechanical Data**

- Case: SOT363
- Case Material: Molded Plastic, "Green" Molding Compound
- UL Flammability Classification Rating 94V-0
- Moisture Sensitivity: Level 1 per J-STD-020
- Terminals: Finish – Matte Tin Plated Leads, Solderable per MIL-STD-202, Method 208 Ⓢ3
- Weight: 0.006 grams (Approximate)

Part Number	R1 Only
DDA113TU	1kΩ
DDA143TU	4.7kΩ
DDA114TU	10kΩ



Top View

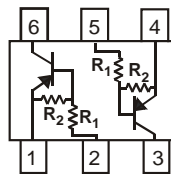

R1, R2

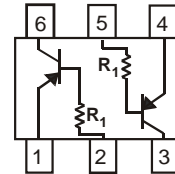

R1 Only

Device Schematic

**Ordering Information** (Notes 4, 5 & 6)

Product	Status	Compliance	Marking	Reel Size (inches)	Tape Width (mm)	Quantity per Reel
DDA124EU-7-F	Active	AEC-Q101	P17	7	8	3,000
DDA124EUQ-7-F	Active	Automotive	P17	7	8	3,000
DDA124EUQ-13-F	Active	Automotive	P17	13	8	10,000
DDA144EU-7-F	Active	AEC-Q101	P20	7	8	3,000
DDA144EUQ-7-F	Active	Automotive	P20	7	8	3,000
DDA114YU-7-F	Active	AEC-Q101	P14	7	8	3,000
DDA114YUQ-7-F	NRND (Use ADA114YUQ)	Automotive	P14	7	8	3,000
DDA123JU-7-F	Active	AEC-Q101	P06	7	8	3,000
DDA114EU-7-F	Active	AEC-Q101	P13	7	8	3,000
DDA114EUQ-7-F	NRND (Use ADA114EUQ)	Automotive	P13	7	8	3,000
DDA113TU-7-F	Active	AEC-Q101	P01	7	8	3,000
DDA143TU-7-F	Active	AEC-Q101	P07	7	8	3,000
DDA143TUQ-7-F	Active	Automotive	P07	7	8	3,000
DDA143TUQ-13-F	Active	Automotive	P07	13	8	10,000
DDA114TU-7-F	Active	AEC-Q101	P12	7	8	3,000
DDA114TUQ-7-F	Active	Automotive	P12	7	8	3,000
DDA114TUQ-13-F	Active	Automotive	P12	13	8	10,000

- Notes:
1. No purposely added lead. Fully EU Directive 2002/95/EC (RoHS), 2011/65/EU (RoHS 2) & 2015/863/EU (RoHS 3) compliant.
  2. See <https://www.diodes.com/quality/lead-free/> for more information about Diodes Incorporated's definitions of Halogen- and Antimony-free, "Green" and Lead-free.
  3. Halogen- and Antimony-free "Green" products are defined as those which contain <900ppm bromine, <900ppm chlorine (<1500ppm total Br + Cl) and <1000ppm antimony compounds.
  4. Automotive products are AEC-Q101 qualified and are PPAP capable. Automotive, AEC-Q101 and standard products are electrically and thermally the same, except where specified. For more information, please refer to <http://www.diodes.com/quality/>.
  5. For packaging details, go to our website at <https://www.diodes.com/design/support/packaging/diodes-packaging/>.
  6. NRND = Not Recommended for New Design.

## Marking Information

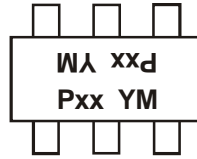

Pxx = Product Type Marking Code (See Ordering Information)  
 YM = Date Code Marking  
 Y = Year (ex: F = 2018)  
 M = Month (ex: 9 = September)

### Date Code Key

Year	2018	2019	2020	2021	2022	2023	2024	2025	2026	2027	2028	2029	2030	2031
Code	F	G	H	I	J	K	L	M	N	O	P	Q	R	S
Month	Jan	Feb	Mar	Apr	May	Jun	Jul	Aug	Sep	Oct	Nov	Dec		
Code	1	2	3	4	5	6	7	8	9	O	N	D		

## Absolute Maximum Ratings (@T<sub>A</sub> = +25°C, unless otherwise specified.)

Characteristic		Symbol	Value	Unit
Supply Voltage (1) to (6) and (4) to (3)		V <sub>CC</sub>	-50	V
Input Voltage (1) to (2) and (4) to (5)	DDA124EU	V <sub>IN</sub>	+10 to -40	V
	DDA144EU		+10 to -40	
	DDA114YU		+6 to -40	
	DDA123JU		+5 to -12	
	DDA114EU		+10 to -40	
	DDA113TU		+5V Max	
	DDA143TU		+5V Max	
Output Current	DDA124EU	I <sub>O</sub>	-30	mA
	DDA144EU		-30	
	DDA114YU		-70	
	DDA123JU		-100	
	DDA114EU		-50	
	DDA113TU		-100	
	DDA143TU		-100	
DDA114TU	-100			
Output Current	I <sub>C(MAX)</sub>	-100	mA	

## Thermal Characteristics (@T<sub>A</sub> = +25°C, unless otherwise specified.)

Characteristic	Symbol	Value	Unit
Power Dissipation (Notes 7 & 8)	P <sub>D</sub>	200	mW
Thermal Resistance, Junction to Ambient Air (Note 7)	R <sub>θJA</sub>	625	°C/W
Operating and Storage Temperature Range	T <sub>J</sub> , T <sub>STG</sub>	-55 to +150	°C

Notes: 7. Mounted on FR-4 PC Board with minimum recommended pad layout.  
 8. 150mW per element must not be exceeded.

**Electrical Characteristics** (@T<sub>A</sub> = +25°C, unless otherwise specified.)

Characteristic (DDA113TU & DDA143TU & DDA114TU only)	Symbol	Min	Typ	Max	Unit	Test Condition
Collector-Base Breakdown Voltage	BV <sub>CBO</sub>	-50	—	—	V	I <sub>C</sub> = -50μA
Collector-Emitter Breakdown Voltage	BV <sub>CEO</sub>	-50	—	—	V	I <sub>C</sub> = -1mA
Emitter-Base Breakdown Voltage	BV <sub>EBO</sub>	-5	—	—	V	I <sub>E</sub> = -50μA
Collector Cutoff Current	I <sub>CBO</sub>	—	—	-0.5	μA	V <sub>CB</sub> = -50V
Emitter Cutoff Current	I <sub>EBO</sub>	—	—	-0.5	μA	V <sub>EB</sub> = -4V
Collector-Emitter Saturation Voltage	V <sub>CE(SAT)</sub>	—	—	-0.3	V	I <sub>C</sub> /I <sub>B</sub> = -2.5mA / -0.25mA DDA143TU I <sub>C</sub> /I <sub>B</sub> = -1mA / -0.1mA DDA114TU I <sub>C</sub> /I <sub>B</sub> = -10mA / -1mA DDA113TU
DC Current Transfer Ratio	h <sub>FE</sub>	100 160	250 —	600 —	—	I <sub>C</sub> = -1mA, V <sub>CE</sub> = -5V I <sub>C</sub> = -1mA, V <sub>CE</sub> = -5V DDA143TUQ
Input Resistor (R <sub>1</sub> ) Tolerance	ΔR <sub>1</sub>	-30	—	+30	%	—
Gain-Bandwidth Product (Note 9)	f <sub>T</sub>	—	250	—	MHz	V <sub>CE</sub> = -10V, I <sub>E</sub> = 5mA, f = 100MHz

Characteristic	Symbol	Min	Typ	Max	Unit	Test Condition	
Input Voltage	V <sub>I(OFF)</sub>	DDA124EU	-0.5	-1.1	—	V	V <sub>CC</sub> = -5V, I <sub>O</sub> = -100μA
		DDA144EU	-0.5	-1.1			
DDA114YU		-0.3	—				
DDA123JU		-0.5	—				
DDA114EU		-0.5	-1.1				
Output Voltage	V <sub>I(ON)</sub>	DDA124EU	—	-1.9	-3.0	V	V <sub>O</sub> = -0.3, I <sub>O</sub> = -5mA V <sub>O</sub> = -0.3, I <sub>O</sub> = -2mA V <sub>O</sub> = -0.3, I <sub>O</sub> = -1mA V <sub>O</sub> = -0.3, I <sub>O</sub> = -5mA V <sub>O</sub> = -0.3, I <sub>O</sub> = -10mA
		DDA144EU	—	-1.9	-3.0		
		DDA114YU	—	—	-1.4		
		DDA123JU	—	—	-1.1		
		DDA114EU	—	-1.9	-3.0		
Output Voltage	V <sub>O(ON)</sub>	DDA124EU	—	-0.1	-0.3	V	I <sub>O</sub> /I <sub>I</sub> = -10mA / -0.5mA I <sub>O</sub> /I <sub>I</sub> = -10mA / -0.5mA I <sub>O</sub> /I <sub>I</sub> = -5mA / -0.25mA I <sub>O</sub> /I <sub>I</sub> = -5mA / -0.25mA I <sub>O</sub> /I <sub>I</sub> = -10mA / -0.5mA
		DDA144EU	—	-0.1	-0.3		
		DDA114YU	—	-0.1	-0.3		
		DDA123JU	—	-0.1	-0.3		
		DDA114EU	—	-0.1	-0.3		
Input Current	I <sub>I</sub>	—	—	-0.36 -0.18 -0.88 -3.6 -0.88	mA	V <sub>I</sub> = -5V	
Output Current	I <sub>O(OFF)</sub>	—	—	-0.5	μA	V <sub>CC</sub> = -50V, V <sub>I</sub> = -0V	
DC Current Gain	G <sub>I</sub>	56 60 68 68 80 30	—	—	—	V <sub>O</sub> = -5V, I <sub>O</sub> = -5mA V <sub>O</sub> = -5V, I <sub>O</sub> = -5mA V <sub>O</sub> = -5V, I <sub>O</sub> = -5mA V <sub>O</sub> = -5V, I <sub>O</sub> = -10mA V <sub>O</sub> = -5V, I <sub>O</sub> = -10mA V <sub>O</sub> = -5V, I <sub>O</sub> = -5mA	
Input Resistor (R <sub>1</sub> ) Tolerance	ΔR <sub>1</sub>	-30	—	+30	%	—	
Resistance Ratio Tolerance	R <sub>2</sub> /R <sub>1</sub>	-20	—	+20	%	—	
Gain-Bandwidth Product	f <sub>T</sub>	—	250	—	MHz	V <sub>CE</sub> = -10V, I <sub>E</sub> = -5mA, f = 100MHz	

Note: 9. Transistor - For Reference Only.

**Typical Curves – DDA123JU** (@ $T_A = +25^\circ\text{C}$ , unless otherwise specified.)

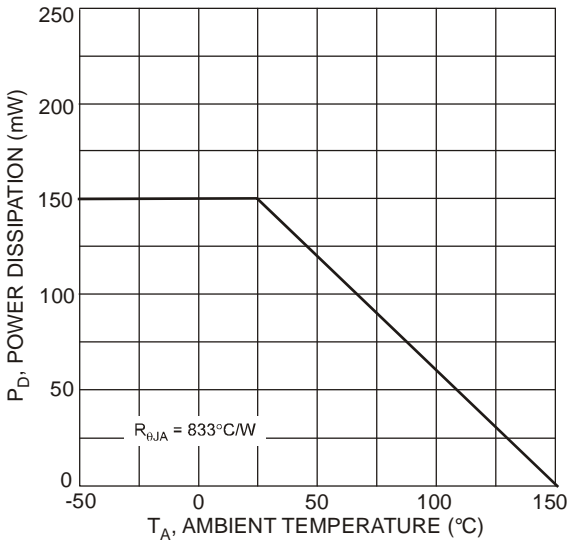

Fig. 1 Power Dissipation vs. Ambient Temperature

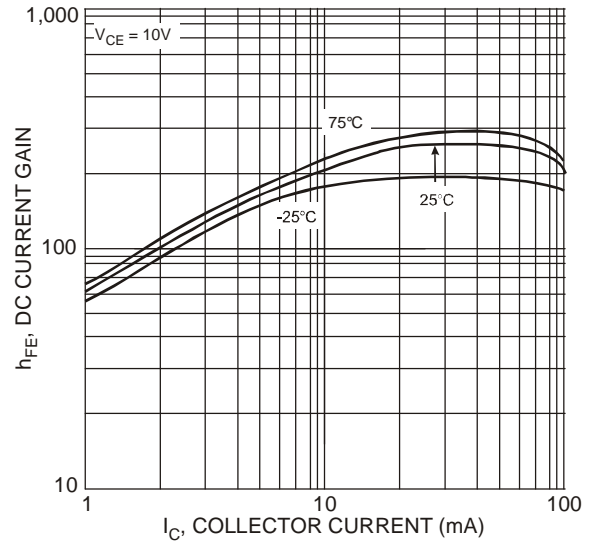

Fig. 2 Typical DC Current Gain vs. Collector Current

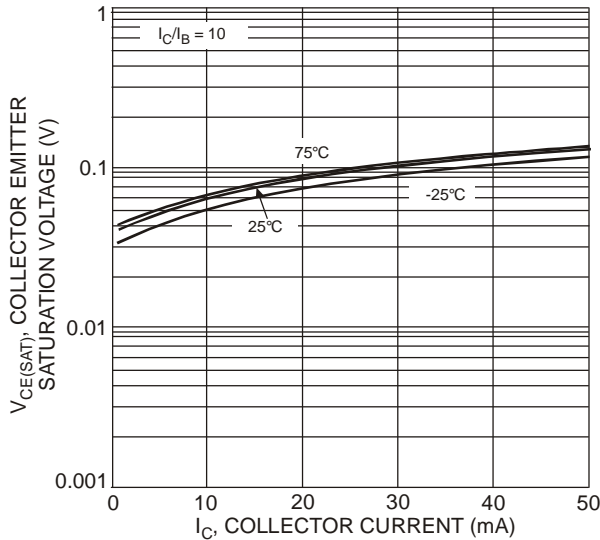

Fig. 3 Typical Collector Emitter Saturation Voltage vs. Collector Current

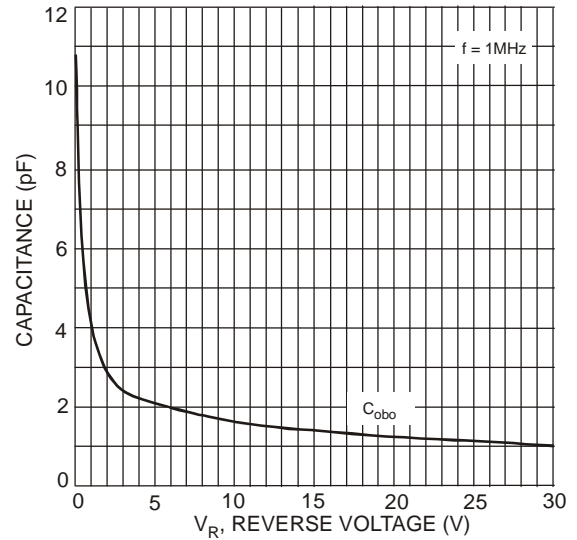

Fig. 4 Typical Capacitance Characteristics

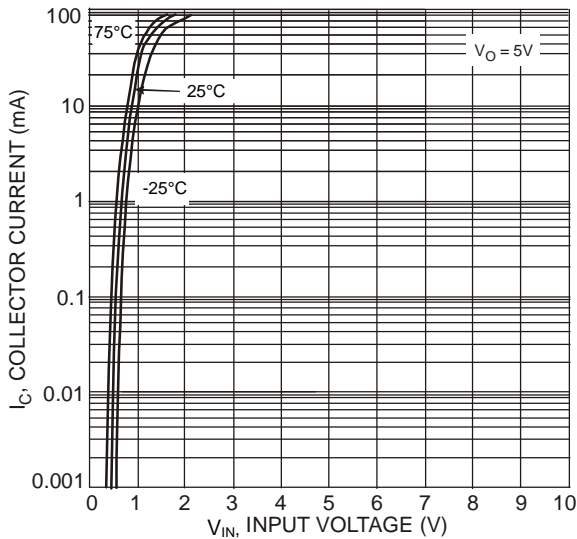

Fig. 5 Collector Current vs. Input Voltage

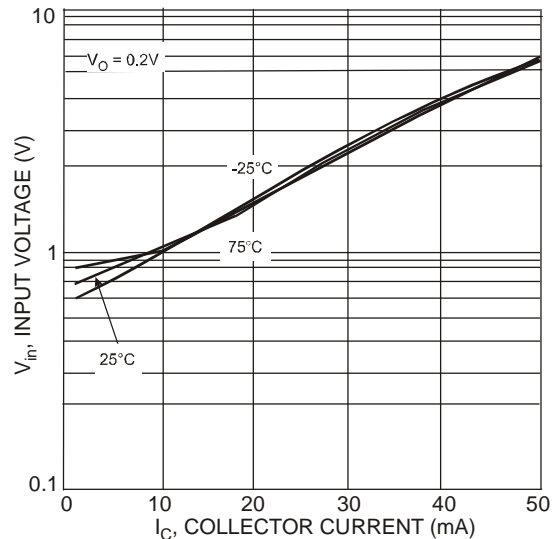

Fig. 6 Input Voltage vs. Collector Current

**Typical Curves – DDA114TU** (@T<sub>A</sub> = +25°C, unless otherwise specified.)

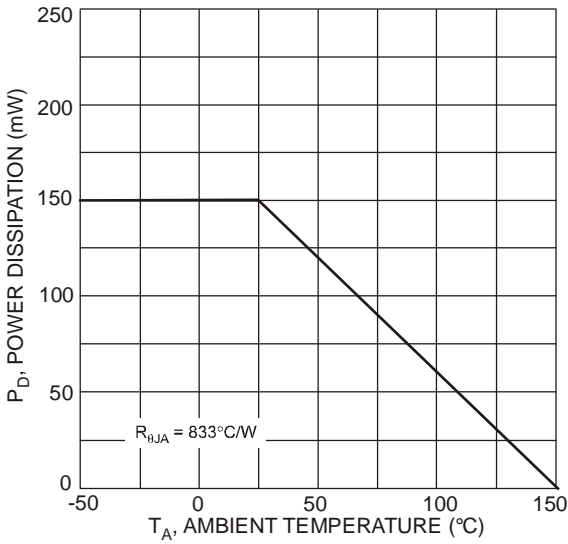

Fig.7 Power Dissipation vs. Ambient Temperature

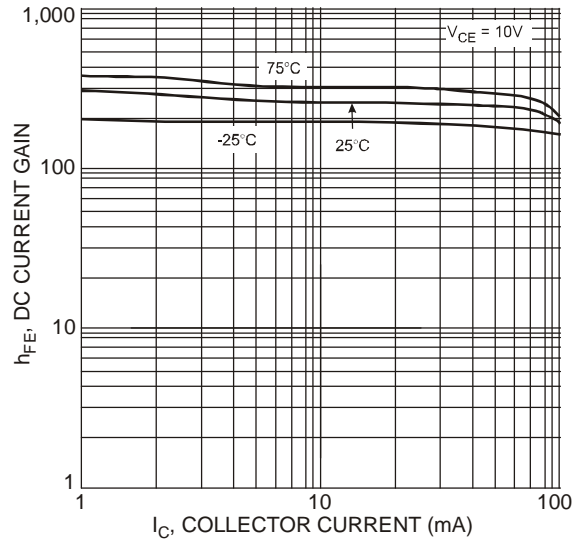

Fig.8 Typical DC Current Gain vs. Collector Current

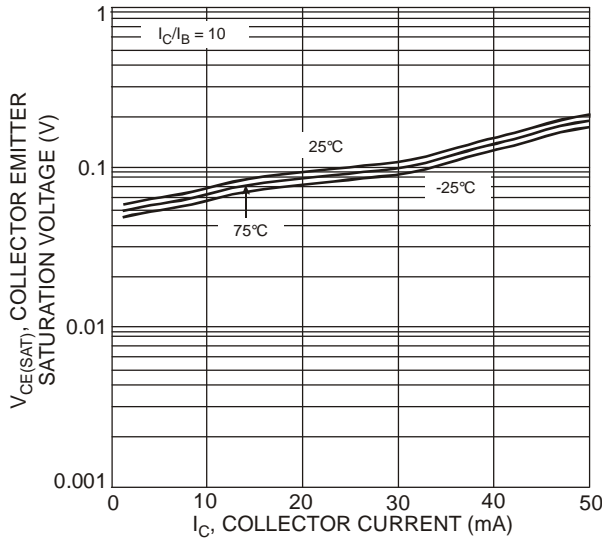

Fig.9 Typical Collector Emitter Saturation Voltage vs. Collector Current

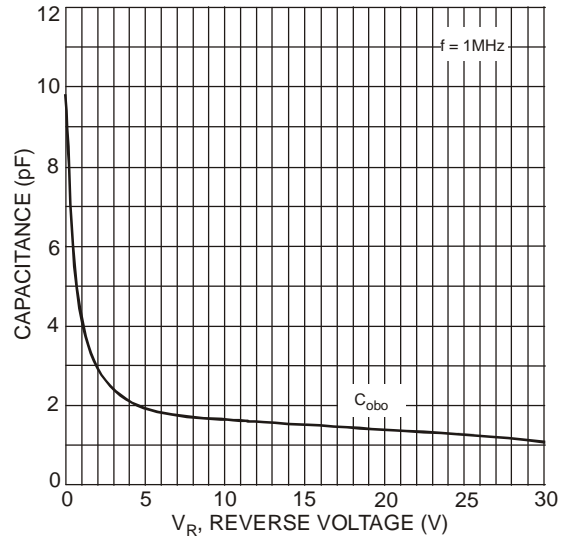

Fig.10 Typical Capacitance Characteristics

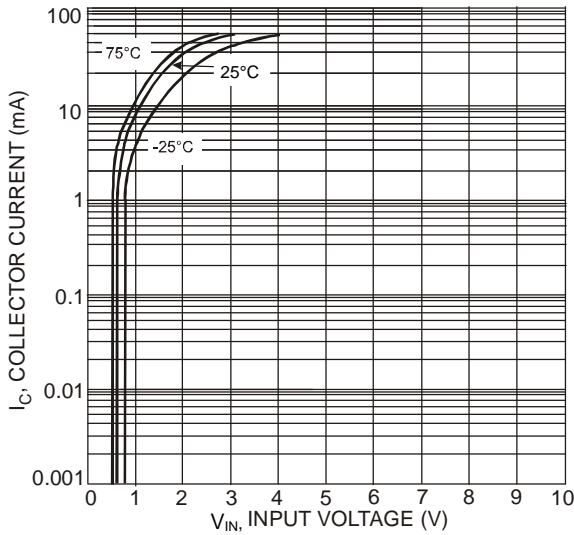

Fig.11 Collector Current vs. Input Voltage

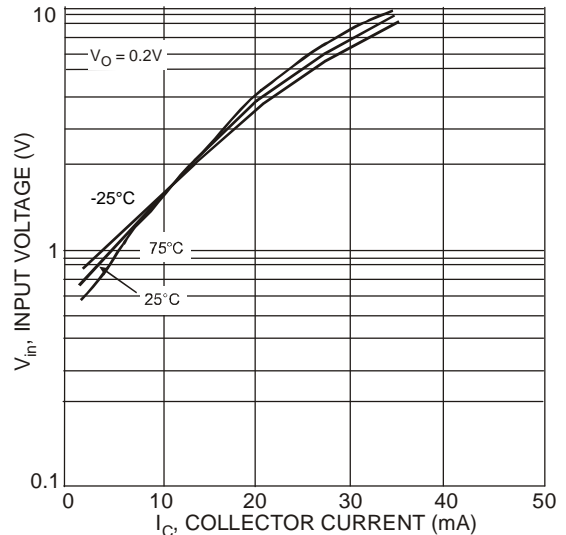
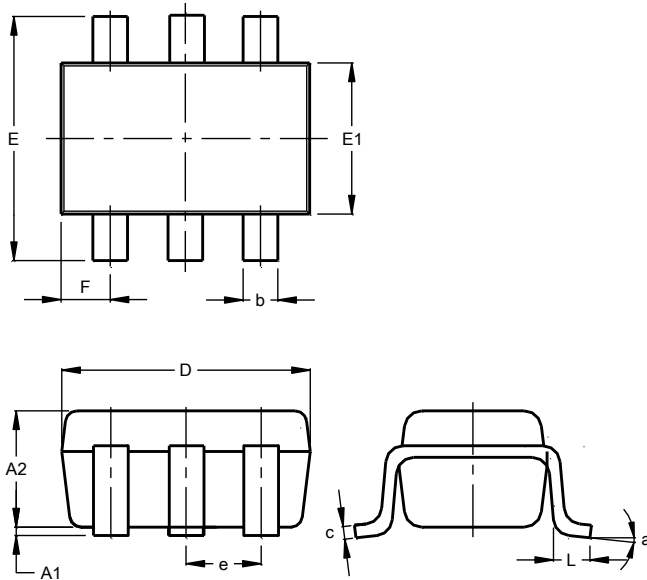

Fig.12 Input Voltage vs. Collector Current

## Package Outline Dimensions

Please see <http://www.diodes.com/package-outlines.html> for the latest version.

### SOT363



SOT363			
Dim	Min	Max	Typ
A1	0.00	0.10	0.05
A2	0.90	1.00	0.95
b	0.10	0.30	0.25
c	0.10	0.22	0.11
D	1.80	2.20	2.15
E	2.00	2.20	2.10
E1	1.15	1.35	1.30
e	0.650 BSC		
F	0.40	0.45	0.425
L	0.25	0.40	0.30
a	0°	8°	--
All Dimensions in mm			

## Suggested Pad Layout

Please see <http://www.diodes.com/package-outlines.html> for the latest version.

### SOT363

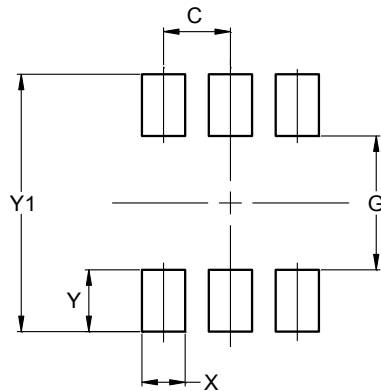

Dimensions	Value (in mm)
C	0.650
G	1.300
X	0.420
Y	0.600
Y1	2.500