

Features

- Epitaxial Planar Die Construction
- Complementary PNP Types Available (DDA)
- Built-In Biasing Resistors
- **Totally Lead-Free & Fully RoHS Compliant (Notes 1 & 2)**
- **Halogen- and Antimony-Free. "Green" Device (Note 3)**
- **The DDC(XXXX)UQs are suitable for automotive applications requiring specific change control; these parts are AEC-Q101 qualified, PPAP capable, and manufactured in IATF 16949 certified facilities.**

<https://www.diodes.com/quality/product-definitions/>

Part Number	R1 (NOM)	R2 (NOM)
DDC124EU	22kΩ	22kΩ
DDC144EU	47kΩ	47kΩ
DDC114YU	10kΩ	47kΩ
DDC123JU	2.2kΩ	47kΩ
DDC114EU	10kΩ	10kΩ
DDC143ZU	4.7kΩ	47kΩ
DDC115EU	100kΩ	100kΩ

Mechanical Data

- Case: SOT363
- Case Material: Molded Plastic, "Green" Molding Compound. UL Flammability Classification Rating 94V-0
- Moisture Sensitivity: Level 1 per J-STD-020
- Terminals: Finish – Matte Tin Plated Leads, Solderable per MIL-STD-202, Method 208 ③
- Weight: 0.006 grams (Approximate)

Part Number	R1 Only
DDC113TU	1kΩ
DDC143TU	4.7kΩ
DDC114TU	10kΩ

SOT363

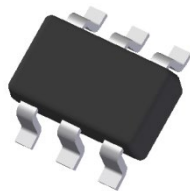

Top View

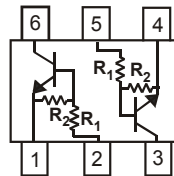

R1, R2

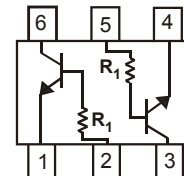

R1 Only

Device Schematic

Ordering Information (Notes 4 & 5)

Part Number	Status	Compliance	Marking	Reel Size (inches)	Tape Width (mm)	Quantity per Reel
DDC124EU-7-F	Active	Standard	N17	7	8	3,000
DDC124EUQ-7-F	NRND (Use ADC124EUQ)	Automotive	N17	7	8	3,000
DDC144EU-7-F	Active	Standard	N20	7	8	3,000
DDC114YU-7-F	Active	Standard	N14	7	8	3,000
DDC114YUQ-7-F	NRND (Use ADC114YUQ)	Automotive	N14	7	8	3,000
DDC114YUQ-13-F	NRND (Use ADC114YUQ)	Automotive	N14	13	8	10,000
DDC123JU-7-F	Active	Standard	N06	7	8	3,000
DDC114EU-7-F	Active	Standard	N13	7	8	3,000
DDC114EUQ-7-F	NRND (Use ADC114EUQ)	Automotive	N13	7	8	3,000
DDC114EUQ-13-F	NRND (Use ADC114EUQ)	Automotive	N13	13	8	10,000
DDC113TU-7-F	Active	Standard	N01	7	8	3,000
DDC143TU-7-F	Active	Standard	N07	7	8	3,000
DDC114TU-7-F	Active	Standard	N12	7	8	3,000
DDC114TUQ-7-F	Active	Automotive	N12	7	8	3,000
DDC143ZU-7-F	Active	Standard	N03	7	8	3,000
DDC115EU-7-F	Active	Standard	N02	7	8	3,000

- Notes:
1. No purposely added lead. Fully EU Directive 2002/95/EC (RoHS), 2011/65/EU (RoHS 2) & 2015/863/EU (RoHS 3) compliant.
 2. See <https://www.diodes.com/quality/lead-free/> for more information about Diodes Incorporated's definitions of Halogen- and Antimony-free, "Green" and Lead-free.
 3. Halogen- and Antimony-free "Green" products are defined as those which contain <900ppm bromine, <900ppm chlorine (<1500ppm total Br + Cl) and <1000ppm antimony compounds.
 4. For packaging details, go to our website at <https://www.diodes.com/design/support/packaging/diodes-packaging/>.
 5. NRND = Not Recommended for New Design.

Marking Information

SOT363

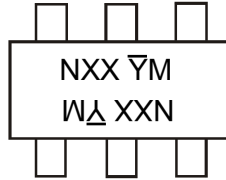

NXX = Product Type Marking Code (See Ordering Information)
 YM = Date Code Marking
 Y = Year (ex: H = 2020)
 M = Month (ex: 9 = September)

Date Code Key

Year	2002	2020	2021	2022	2023	2024	2025	2026	2027	2028	2029
Code	O	H	I	J	K	L	M	N	O	P	R

Month	Jan	Feb	Mar	Apr	May	Jun	Jul	Aug	Sep	Oct	Nov	Dec
Code	1	2	3	4	5	6	7	8	9	O	N	D

Absolute Maximum Ratings (@ T_A = +25°C, unless otherwise specified.)

Characteristic	Symbol	Value	Unit
Supply Voltage, <Pin: (6) to (1) and (3) to (4)>	V _{CC}	50	V
Input Voltage, <Pin: (2) to (1) and (5) to (4)>	V _{IN}	DDC124EU	-10 to +40
		DDC144EU	-10 to +40
		DDC114YU	-6 to +40
		DDC123JU	-5 to +12
		DDC114EU	-10 to +40
		DDC113TU	-5V max
		DDC143TU	-5V max
		DDC114TU	-5V max
		DDC143ZU	-5 to +30
DDC115EU	-10 to +40		
Output Current	I _O	DDC124EU	30
		DDC144EU	30
		DDC114YU	70
		DDC123JU	100
		DDC114EU	50
		DDC113TU	100
		DDC143TU	100
		DDC114TU	100
		DDC143ZU	100
DDC115EU	20		
Output Current	I _{C(MAX)}	100	mA

Thermal Characteristics (@ T_A = +25°C, unless otherwise specified.)

Characteristic	Symbol	Value	Unit
Power Dissipation (Notes 6 & 7)	P _D	200	mW
Thermal Resistance, Junction to Ambient Air (Note 6)	R _{θJA}	625	°C/W
Operating and Storage Temperature Range	T _J , T _{STG}	-55 to +150	°C

- Notes:
- 6. Mounted on FR-4 PC Board with minimum recommended pad layout.
 - 7. 150mW per element must not be exceeded.

Electrical Characteristics (@ T_A = +25°C, unless otherwise specified.)
For R1 Only Devices: DDC113TU & DDC143TU & DDC114TU

Characteristic	Symbol	Min	Typ	Max	Unit	Test Condition
Collector-Base Breakdown Voltage	BV _{CBO}	50	—	—	V	I _C = 50μA
Collector-Emitter Breakdown Voltage	BV _{CEO}	50	—	—	V	I _C = 1mA
Emitter-Base Breakdown Voltage	BV _{EBO}	5	—	—	V	I _E = 50μA
Collector Cutoff Current	I _{CBO}	—	—	0.5	μA	V _{CB} = 50V
Emitter Cutoff Current	I _{EBO}	—	—	0.5	μA	V _{EB} = 4V
Collector-Emitter Saturation Voltage	V _{CE(sat)}	—	—	0.3	V	I _C /I _B = 2.5mA / 0.25mA DDC143TU I _C /I _B = 1mA / 0.1mA DDC114TU I _C /I _B = 10mA / 1mA DDC113TU
DC Current Transfer Ratio	h _{FE}	100	250	600	—	I _C = 1mA, V _{CE} = 5V
Input Resistor (R ₁) Tolerance	ΔR ₁	-30	—	+30	%	—
Gain-Bandwidth Product (Note 8)	f _T	—	250	—	MHz	V _{CE} = 10V, I _E = -5mA, f = 100MHz

Electrical Characteristics (@ T_A = +25°C, unless otherwise specified.)
For R1, R2 Devices: DDC124EU & DDC144EU & DDC114YU & DDC123JU & DDC114EU & DDC143ZU & DDC115EU

Characteristic	Symbol	Min	Typ	Max	Unit	Test Condition	
Input Voltage	V _{I(OFF)}	DDC124EU	0.5	1.1	—	V	V _{CC} = 5V, I _O = 100μA
		DDC144EU	0.5	1.1			
DDC114YU		0.3	—				
DDC123JU		0.5	—				
DDC114EU		0.5	1.1				
DDC143ZU		0.5	—				
DDC115EU		0.5	—				
Input Voltage	V _{I(ON)}	DDC124EU	—	1.9	3.0	V	V _O = 0.3V, I _O = 5mA V _O = 0.3V, I _O = 2mA V _O = 0.3V, I _O = 1mA V _O = 0.3V, I _O = 5mA V _O = 0.3V, I _O = 10mA V _O = 0.3V, I _O = 5mA V _O = 0.3V, I _O = 1mA
		DDC144EU	—	1.9	3.0		
		DDC114YU	—	—	1.4		
		DDC123JU	—	—	1.1		
		DDC114EU	—	1.9	3.0		
		DDC143ZU	—	—	1.3		
		DDC115EU	—	—	3		
Output Voltage	V _{O(ON)}	DDC124EU	—	0.1	0.3	V	I _O /I _L = 10mA / 0.5mA I _O /I _L = 10mA / 0.5mA I _O /I _L = 5mA / 0.25mA I _O /I _L = 5mA / 0.25mA I _O /I _L = 10mA / 0.5mA I _O /I _L = 5mA / 0.25mA I _O /I _L = 10mA / 0.5mA
		DDC144EU					
		DDC114YU					
		DDC123JU					
		DDC114EU					
		DDC143ZU					
		DDC115EU					
Input Current	I _I	DDC124EU	—	—	0.36	mA	V _I = 5V
		DDC144EU			0.18		
		DDC114YU			0.88		
		DDC123JU			3.6		
		DDC114EU			0.88		
		DDC143ZU			1.8		
		DDC115EU			0.15		
Output Current	I _{O(OFF)}	—	—	0.5	μA	V _{CC} = 50V, V _I = 0V	
DC Current Gain	G _I	DDC124EU	56	—	—	—	V _O = 5V, I _O = 5mA
		DDC144EU	68				V _O = 5V, I _O = 5mA
		DDC114YU	68				V _O = 5V, I _O = 10mA
		DDC114YUQ	80				V _O = 5V, I _O = 5mA
		DDC123JU	80				V _O = 5V, I _O = 10mA
		DDC114EU	30				V _O = 5V, I _O = 5mA
		DDC143ZU	80				V _O = 5V, I _O = 10mA
		DDC115EU	82				V _O = 5V, I _O = 5mA
Input Resistor (R ₁) Tolerance	ΔR ₁	-30	—	+30	%	—	
Resistance Ratio Tolerance	Δ(R ₂ /R ₁)	-20	—	+20	%	—	
Gain-Bandwidth Product (Note 8)	f _T	—	250	—	MHz	V _{CE} = 10V, I _E = 5mA, f = 100MHz	

Note: 8. Transistor - for reference only.

Typical Curves – DDC123JU (@ $T_A = +25^\circ\text{C}$, unless otherwise specified.)

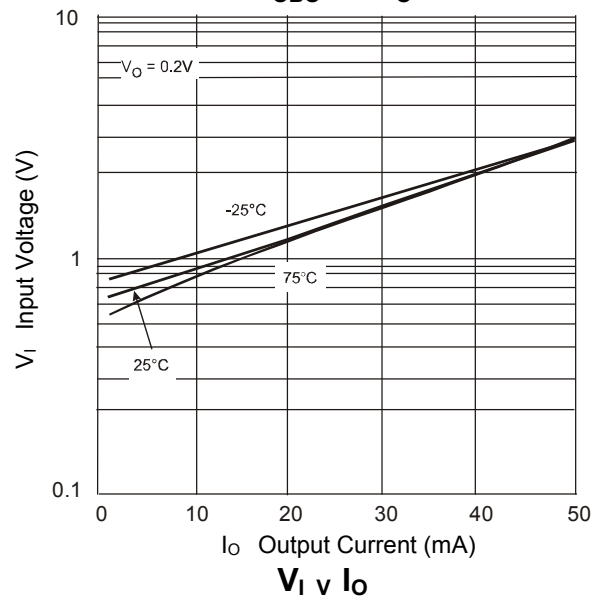
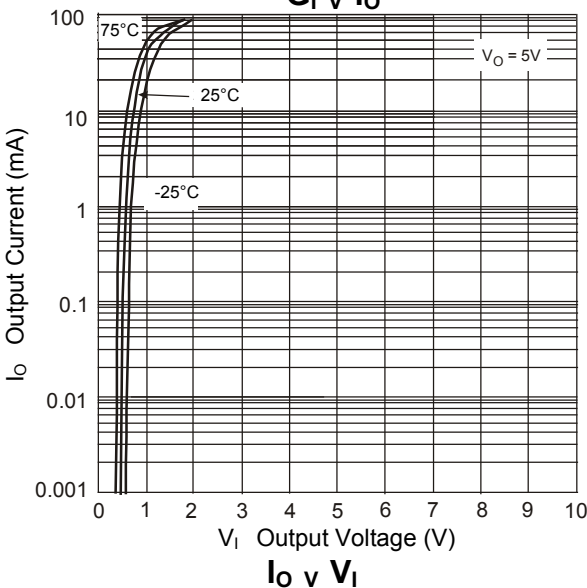
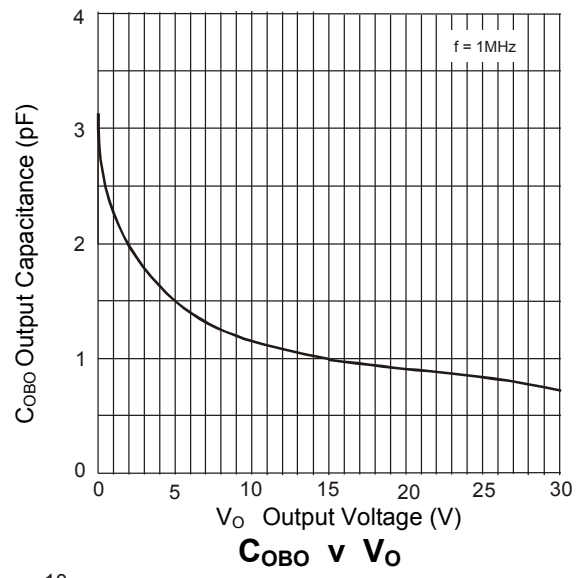
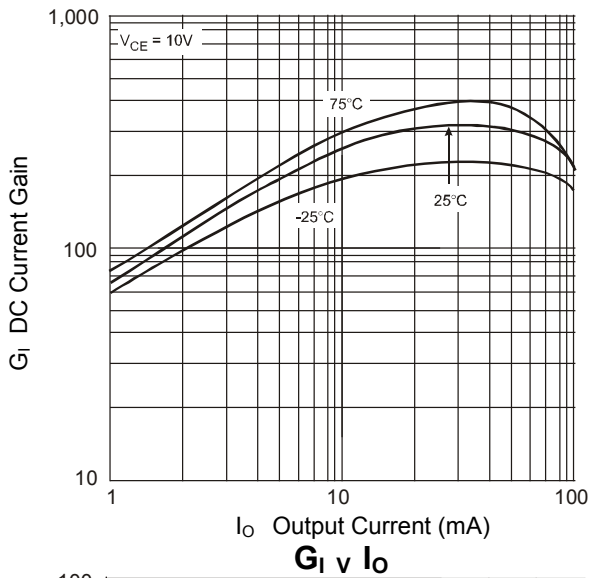
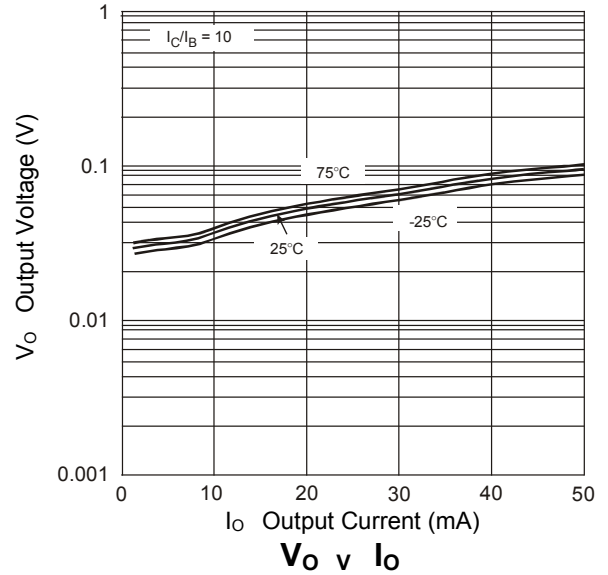
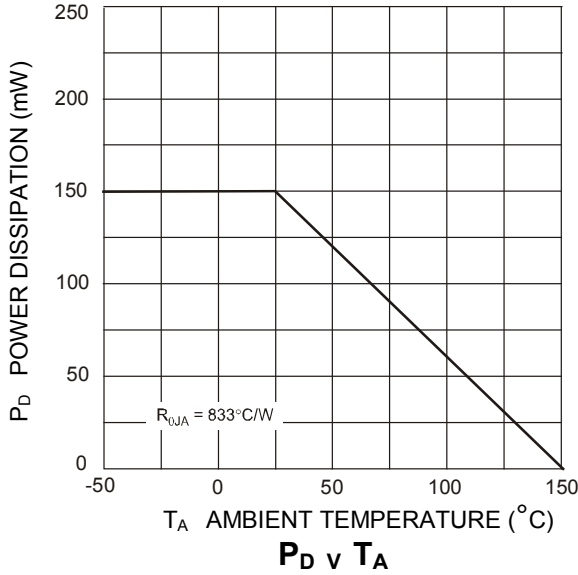

Typical Curves – DDC114YU (@ $T_A = +25^\circ\text{C}$, unless otherwise specified.)

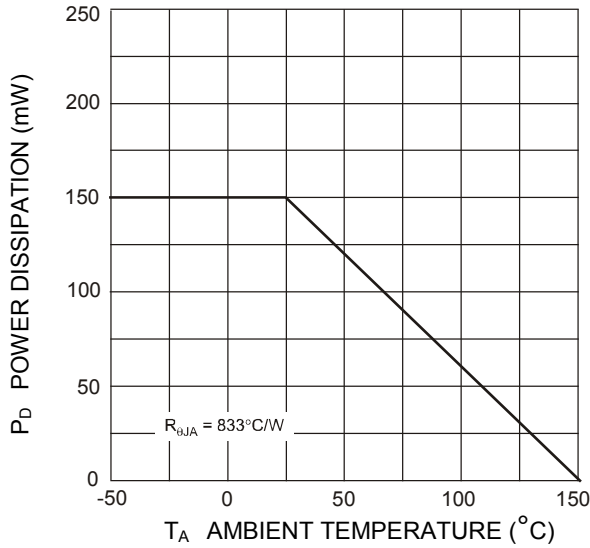

P_D v T_A

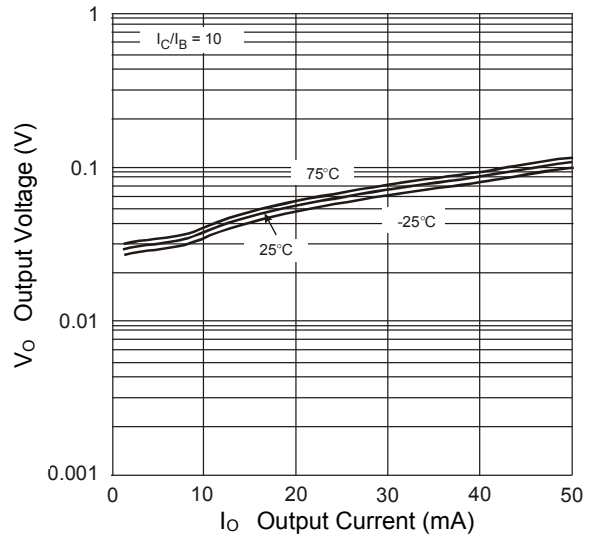

V_O v I_O

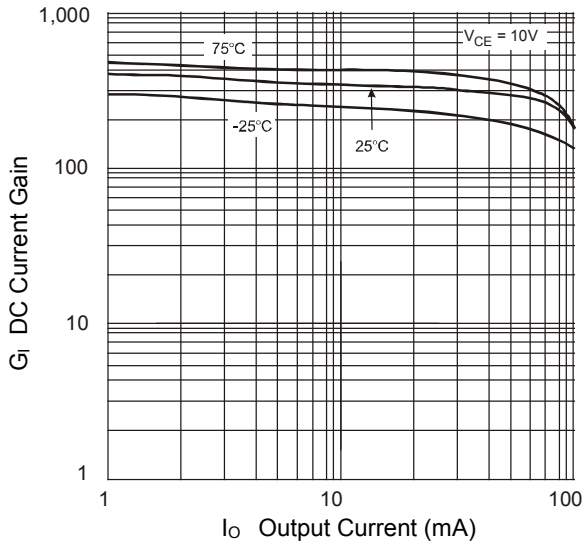

G_I v I_O

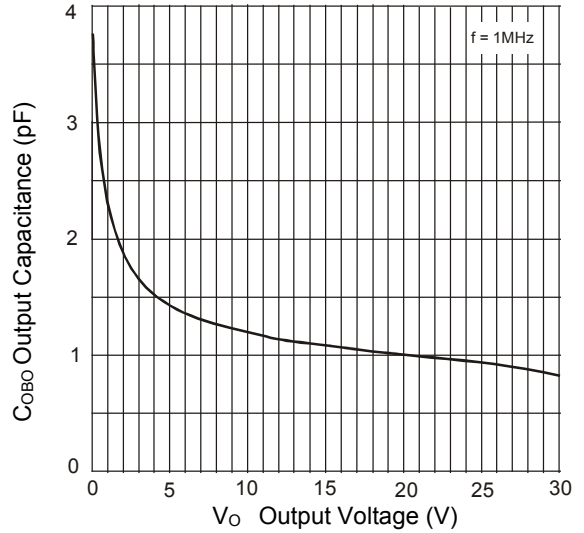

C_{OBO} v V_O

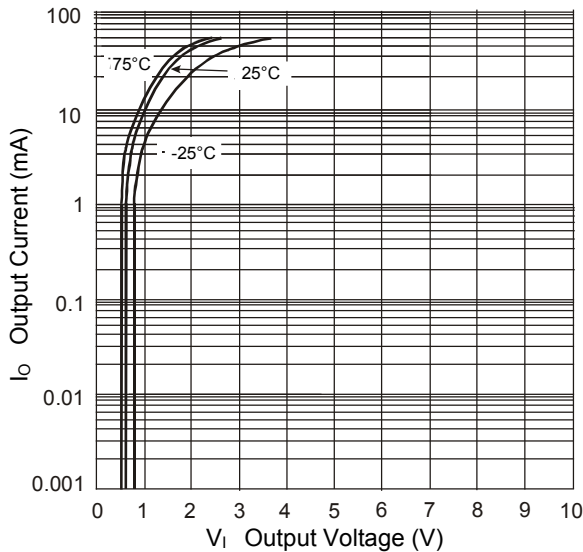

I_O v V_I

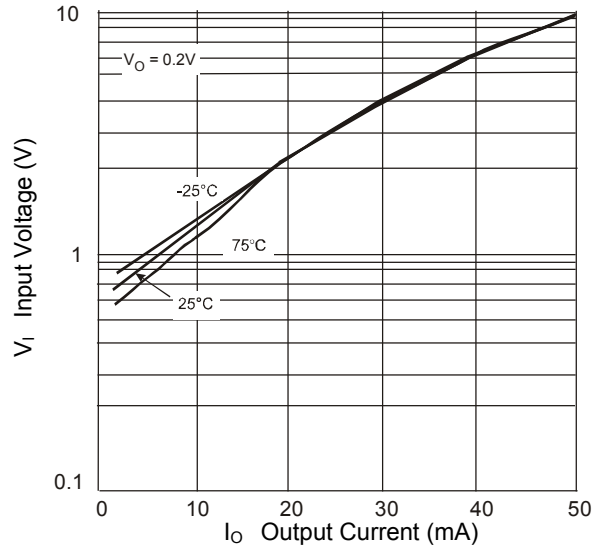

V_I v I_O

Typical Curves – DDC124EU (@ $T_A = +25^\circ\text{C}$, unless otherwise specified.)

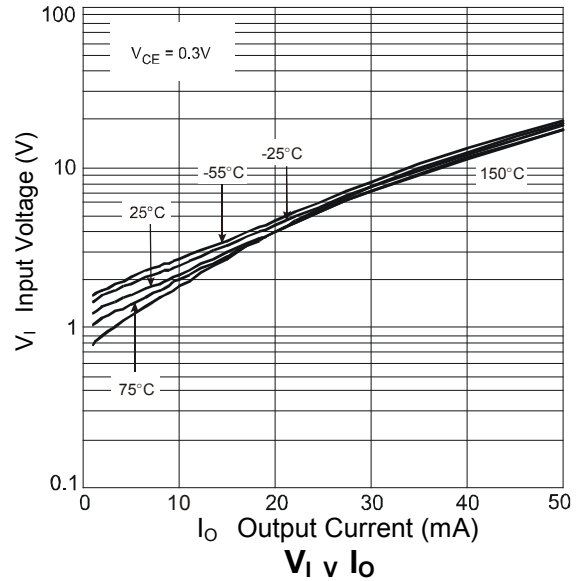
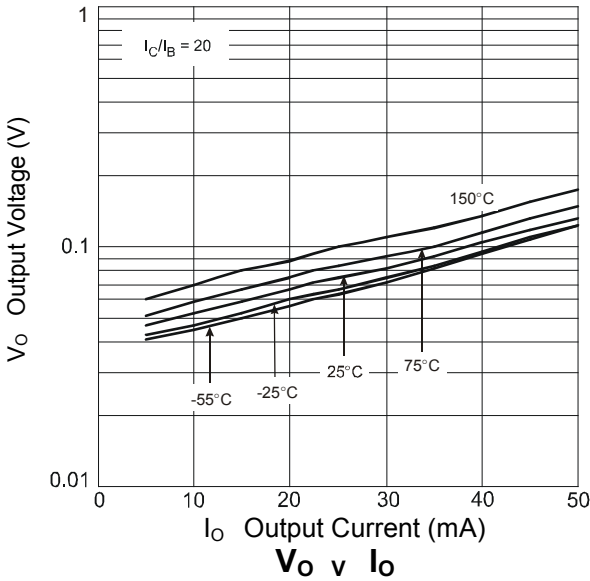
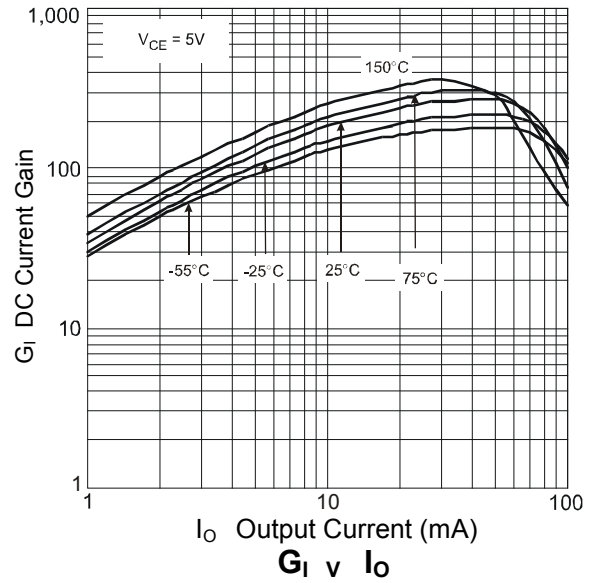
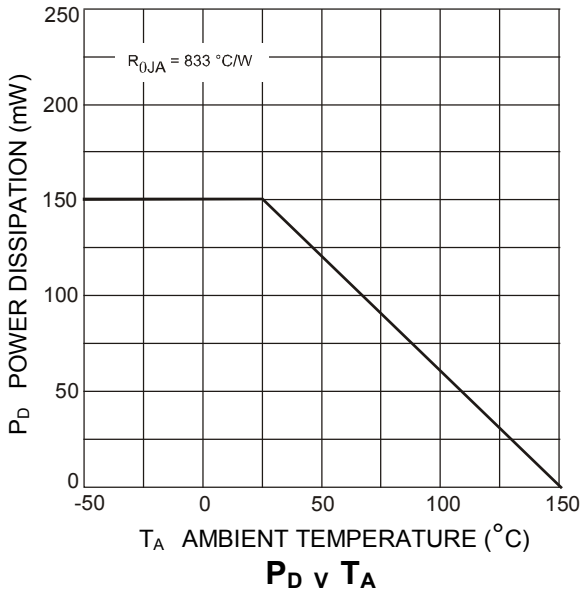

Package Outline Dimensions

Please see <http://www.diodes.com/package-outlines.html> for the latest version.

SOT363

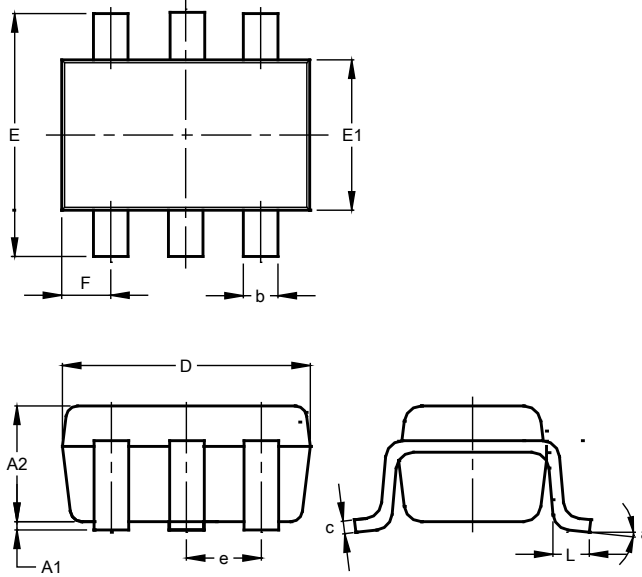

SOT363			
Dim	Min	Max	Typ
A1	0.00	0.10	0.05
A2	0.90	1.00	0.95
b	0.10	0.30	0.25
c	0.10	0.22	0.11
D	1.80	2.20	2.15
E	2.00	2.20	2.10
E1	1.15	1.35	1.30
e	0.650 BSC		
F	0.40	0.45	0.425
L	0.25	0.40	0.30
a	0°	8°	--
All Dimensions in mm			

Suggested Pad Layout

Please see <http://www.diodes.com/package-outlines.html> for the latest version.

SOT363

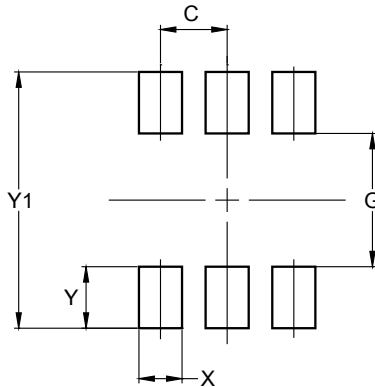

Dimensions	Value (in mm)
C	0.650
G	1.300
X	0.420
Y	0.600
Y1	2.500